

02

MAN

Group	Page
Spring Suspension	001
Cabin	013
Stabilizer	020
Brake	032
Axle & Wheel	039
Steering & Suspension	045
Engine	075
Shaft	077
Gearbox	078
Radiator & Fan Group	079
Exhaust	087
Shock Absorber & Gas Spring	089
Chassis & Body	093
Clutch	094



Auger Nr.	OEM Nr.	Description	Model	Picture
51452	81.96020.0250	Rubber Bushing for Spring	10/11.150/180/190/220/230	
	81.96020.0231		12.220	
	81.96020.0252	ø16xø50x95	13.210/220/230 6/8.90 F/FR 8/9.136 8/9.136 F/FR 8/9.136/170 G 90 L 2000 M 2000 M 90	
51454D	81.43722.0061	Rubber Bushing for Spring	18.220/290/370	
	81.43722.0044	ø24xø70x95	26T6 F 2000 ÖAF	
51455	81.43722.0051	Rubber Bushing for Spring	12.220	
	81.43722.0078		14.280	
	81.43722.0079	ø20xø57x84	L 2000 M 2000	
51456D	81.43722.0062	Rubber Bushing for Spring	F 2000	
	81.43722.0045	ø24xø70x105	ÖAF	
53274D	81.96210.0616	Rubber Bushing for Spring	ECT18/26	
	81.43722.0070	ø24xø65x95	TGA TGS TGX	
54432D	81.43722.0087	Rubber Bushing for Spring	TGA	
		ø24xø65x100		

Auger Nr.	OEM Nr.	Description	Model	Picture
55111	81.43722.0060	Rubber Bushing For Spring ø20xø57x84	14.280 12.220 L 2000 M 2000 SONDERFAHRZEUGE	
55112	81.43722.0091	Rubber Bushing For Spring ø24xø62x95	TGA TGS TGX ECT 18/26T SONDERFAHRZEUGE	
55113	85.43722.0010 85.43722.0008	Rubber Bushing For Spring ø18xø61x86	TGL	
55114	85.43722.0011	Rubber Bushing For Spring ø20xø57x86	TGM	
55115	81.43722.0092	Rubber Bushing For Spring ø20xø62x95	TGM	
55117	85.43722.0009 81.96210.0557	Rubber Bushing For Spring ø18xø57x86	TGA TGL	

Auger Nr.	OEM Nr.	Description	Model	Picture
54631	81.96210.0540	Spring Buffer	TGA	
	81.96210.0539	M12x1.5/ø100x85.5	TGS TGX ECT 18T/26T	
54632	81.96210.0552	Spring Buffer	TGA	
	81.96210.0551	M12x1.5/ø100x86	TGS	
	81.96210.0541		TGX ECT 18T/26T	
54633	85.96210.0025	Spring Buffer ø17.5xø67.5x72.5	TGL	
51489	81.96020.6006	Spring Buffer	14/15.220 - 15/19.240	
	81.96020.0172		16.200/220/240/280/290/360/372	
	81.96020.0136	ø95.5x96	16/19/26/27/30/32/33/34.281	
	81.96020.0110		291/321/331/361 17.220/240 - 18.220/290/370 - 19.240 22/24/25.220/240/281/291/321/331/361 26/32.365 - 26T F 2000 - F 90 - L 2000 M 2000 - M 90 ÖAF - TGA	
53276	81.96020.0230	Spring Buffer	6/8.90	
	81.96020.0277		8/9.136/170	
	81.96020.0280	ø70x80	G 90 L 2000 M 2000	
51513	81.96210.0402	Spring Buffer M12/41	G 90 L 2000 M 2000	

Auger Nr.	OEM Nr.	Description	Model	Picture
53017	81.96210.0431	Spring Buffer	L 2000	
	81.96210.0532	M8/19	M 2000 M 90	
51484	81.96101.0739	Spring Buffer	G 90	
	81.96101.0690	ø70x20	L 2000 M 2000 M 90 M 2000 L M 2000 M	
53262	81.43407.0109	Spring Buffer	18220/290/370	
	81.43407.0509	84x110x18	ECT18/26 F 2000 F 90 L 2000 M 2000 ÖAF TGA	
51485	83.96020.0506	Spring Buffer	F 90	
	81.43400.6484	105x87.5x18.5	F 2000 ÖAF	
53280	81.43407.0102	Spring Buffer 100x140x18	F 2000 ÖAF	
55103	81.43407.0112	Spring Buffer 80x120x18	TGS TGA L 2000 M 2000 TGM F 2000 SONDERFAHRZEUGE	

Auger Nr.	OEM Nr.	Description	Model	Picture
52720	81.96210.5022	Spring Cushion	F 2000	
	81.96210.5021	h:127	F 90	
	81.96210.5023		L 2000 ÖAF	
53016	81.96210.5025	Spring Cushion	ÖAF	
	81.96210.5026	h:166	F 2000	
	81.96210.5027			
53271	81.96210.0555	Spring Cushion Left	F 2000	
	81.96210.0548	h:133	TGA	
53272	81.96210.0554	Spring Cushion Light	F 2000	
	81.96210.0547	h:133	TGA	
54177	81.96210.0550	Spring Cushion h:154	TGA F 2000	



Auger Nr.	O.E.M. Nr.	A	B	C	Type
51461	81.41306.0090 81.41306.0070 - 81.41306.0087	ø25	130	-	1
51462	81.41306.0081 81.41306.0072 - 81.41306.0058	ø25	143	-	1
51463	81.41306.0084 - 81.41306.0071 81.41306.0067 - 81.41306.0080 - 81.41306.0055	ø25	143	-	1
51464	81.41306.0095	ø30	142	-	1
51465	81.41306.0088	ø30	143	-	1
51466	81.41306.0089	ø30	145	-	1
51467	81.41306.0092 81.91001.0453	ø30	160	-	1
51468	81.41306.0085 - 81.41306.0078 81.41306.0074 - 81.41306.0001	ø30	162.5	-	1
51469	81.41306.0097	ø30	164	-	1
51470	81.41306.0096	ø30	162.5	-	1
55098	81.41306.0082	ø30	126	-	1
55100	81.41306.0086	ø34	172.5	-	1
51471	81.91020.0327 - 81.91020.0255	ø40	161.5	-	1
51472	81.41304.0043 - 81.41304.0008 - 81.43420.0014	ø25	ø30	77	2
51473	81.41304.0042 - 81.43420.0000	ø25	ø30	87	2
51474	81.41304.0041 - 81.41304.0032	ø30	ø36	77.5	2
51475	81.41304.0044 - 81.41304.0052	ø30	ø36	87.5	2
51476	81.41304.0040 - 81.41304.0038 - 81.43420.0012	ø30	ø36	97	2
51477	81.41304.0037 - 81.41304.0031	ø40	ø46	97	2
51480	81.41304.0020	ø42	ø48	95	2
51481	81.41304.0050 - 81.41304.0035 - 81.41304.0029	ø44	ø48	95.5	2
54201	06.01494.4933	M20x2	260	SW 30	3
54202	06.01494.4935	M20x2	240	SW 30	3

Auger Nr.	OEM Nr.	Description	Model	Picture
51461	81.41306.0090	Spring Pin	12.170/192	
	81.41306.0070		14.170/192	
	81.41306.0087	ø25x130	16.170/192	
			17.170/192 M 90	
51462	81.41306.0081	Spring Pin	14/15.220	
	81.41306.0072		15.240	
	81.41306.0058	ø25x143	16.240/280/290	
			ÖAF	
51463	81.41306.0084	Spring Pin	14/15.220/15.240	
	81.41306.0071		16.200/240/280/290	
	81.41306.0067	ø25x143	19.240	
	81.41306.0080		26/32.240/281/301/321	
	81.41306.0055			
51464	81.41306.0095	Spring Pin	19T	
			F 2000	
		ø30x142	F 90	
			ÖAF	
51465	81.41306.0088	Spring Pin	16.220/240/281/291/321/331/361	
			17.220/240	
		ø30x143	19.240/281/291/321/331/361	
			22/24/25/26.220/240/281/291/321/331/361	
			26/27/30/32/33/34.281/291/321/331/361	
			26/32.365	
			F 90 M 90	
51466	81.41306.0089	Spring Pin	F 90	
			M 90	
		ø30x145	ÖAF	

Auger Nr.	OEM Nr.	Description	Model	Picture
51467	81.41306.0092 81.91001.0453	Spring Pin ø30x160	30/32/33/34.281/291/321/331/361	
51468	81.41306.0085 81.41306.0078 81.41306.0074 81.41306.0001	Spring Pin ø30x162.5	14.220 15/22/24/25/26.220/240 16.170/192/200/220/240/280/281/290/ 291/321/331/361 17.170/192/220/240 19.240/281/291/321/331/361 22/24/25/26/27/30/32/33/34.281/291/ 321/331/361 26/32.365 8/9.136 F 90 M 90 ÖAF	
51469	81.41306.0097	Spring Pin ø30x164	19T F 2000 F 90 ÖAF	
51470	81.41306.0096	Spring Pin ø30x162.5	16.200/240/280/290 F 90	
51471	81.91020.0327 81.91020.0255	Spring Pin ø40x161.5	-	
55098	81.41306.0082	Spring Pin ø30x126	12.170/192 14.170/192 M 90	
55100	81.41306.0086	Spring Pin ø34x172.5	TGS TGA F 2000 ÖAF	

Auger Nr.	OEM Nr.	Description	Model	Picture
51472	81.41304.0043	Spring Bushing ø25xø30x77	12.170/192	
	81.41304.0008		14.170/192	
	81.43420.0014		16.170/192	
			17.170/192	
			M 90 ÖAF	
51473	81.41304.0042	Spring Bushing ø25xø30x87	14.220	
	81.43420.0000		15.220/240	
			16.200/240/280/290	
			19.240	
			26/32.240/281/301/321	
51474	81.41304.0041	Spring Bushing ø30xø36x77.5	12.170/192	
	81.41304.0032		14.170/192	
			16.170/192	
			17.170/192	
			M 90	
51475	81.41304.0044	Spring Bushing ø30xø36x87.5	16.200/220/240/280/281/290/291/321/331/361	
	81.41304.0052		17.220/240 - 24.350/400 18.220/290/310/313/350/370/400/420/460 19.240/281/291/321/331/361 22/24/25/26/220/240/281/291/321/331/361 26.281/291/321/331/361/365 27.281/291/321/331/361 30.281/291/321/331/361 32.281/291/321/331/361/365 33.281/291/321/331/361 34.281/291/321/331/361 EL 202/222/262 F2000 - F90 - M2000 - M90 - ND202 NG 242/252/262/272/312 - NGT 204 NL 202/205/213/222/232/250/252/262/312 NM 152 - ÖAF UEL 242/272/292/312/322	
51476	81.41304.0040	Spring Bushing ø30xø36x97	14/15.220/15.240	
	81.41304.0038		16.220/240/280/281/290/291/321/331/361	
	81.43420.0012		17.220/240	
			18.220/290/370	
			19.240/281/291/321/331/361 22.220/240/281/291/321/331/361 24.220/240/281/291/321/331/361 25.220/240/281/291/321/331/361 26.220/240/281/291/321/331/361 26.281/291/321/331/361/365 30.281/291/321/331/361 32.281/291/321/331/361/365 33.281/291/321/331/361 34.281/291/321/331/361 8/9.136 19T - F 2000 - F 90 - G 90 - M 2000 - M 90 - ÖAF	
51477	81.41304.0037	Spring Bushing ø40xø46x97	-	
	81.41304.0031			

Auger Nr.	OEM Nr.	Description	Model	Picture
51480	81.41304.0020	Spring Bushing ø42xø48x95	-	
51481	81.41304.0050 81.41304.0035 81.41304.0029	Spring Bushing ø44xø48x95.5	- 14/15.220/15.240 17.170/192/220/240 16.170/192/200/240/280281/290/ 291/321/331/361 19.240/281/291/321/331/361 19T - F 90 - M 2000 - M 90	
54201	06.01494.4933	Spring Pin M20x2/260	F 2000 TGA	
54202	06.01494.4935	Spring Pin M20x2/240	F 2000 TGA	
55099	81.90490.0696	Spring Pin M24x2/M18x2/362	TGS TGX TGA ECT 18/26T	
51493	81.45503.0037	Nut for Spring Pin M27x2/41	26T F 2000 F 90 M 2000 ÖAF TGA	

Auger Nr.	OEM Nr.	Description	Model	Picture
54067	06.36959.0027 06.36959.0030	Joint Bearing ø95xø145x31/37	F90 F 2000 TGA	
54629	06.56289.0268	Seal Ring ø134.5xø175/ø180x20	F90 F2000 TGA ÖAF 26T	
55104	81.41351.0006 81.96601.0594	Seal Ring ø185xø195x11.5	TGS ÖAF F 90 TGA L 2000 TGM F 2000	
51491	81.41350.0018	Cradle ø125	26 T F 2000 F 90 ÖAF TGA	
55083	81.41350.0013	Cradle ø128	TGS F2000 F90 TGA L 2000 TGM	
55084	81.41350.0017	Cradle ø150	TGS TGX TGA F 2000 SONDERFAHRZEUGE	

Auger Nr.	OEM Nr.	Description	Model	Picture
51498	81.41320.0092	Spring Bracket	26T/19T	
	81.41320.0089	184x220x217	F 2000	
			F 90	
			M 2000	
			ÖAF	
			TGA	
53095	81.96210.0508	Bogie Suspension Bearing	F 2000	
	81.96210.0507	ø121xø150x100	TGA	
55095	81.96210.0373	Bogie Suspension Bearing	F 2000	
			F 90	
			L 2000	
			TGA	
			TGM	
			TGS	
ÖAF				

Auger Nr.	OEM Nr.	Description	Model	Picture
51507	81.96210.0437 81.96210.0424	Cabin Bushing ø16.5xø70.5x68	F 2000 F 90 M 2000 ÖAF	
54203	85.96210.0028	Cabin Bushing ø16xø50x80	TGL TGM	
54434	85.96020.0004	Cabin Bushing ø22xø52.5x42	TGA TGL TGM ECT 18T/26T	
51502	81.96210.0407 81.96210.0362	Buffer for Cabin ø15xø62x17	F 2000 F 90 M 2000 ÖAF	
51504	81.90713.0909 81.90712.0844	Buffer for Cabin ø33xø65x6	F 2000 F 90 M 2000 ÖAF	
51509	81.96210.0339 83.96210.0500	Buffer for Cabin M16/ø129x91	12.170/192 14.170/192 16.170/192 17.170/192	

Auger Nr.	OEM Nr.	Description	Model	Picture
51510	81.96210.0536	Buffer for Cabin M10/ø50.5x36	F 2000 M 2000 ÖAF	
53268	81.96210.0515 81.96210.0482	Buffer for Cabin M10/ø50.5x36	F 2000 M 2000 ÖAF	
54630	85.96210.0008	Buffer for Cabin ø30xø95x46	L 2000	
51499	81.96210.0393 83.96210.0512	Cabin Mounting ø25/40	TGA 19T 26T	
51500	81.96210.0392 83.96210.0515	Cabin Mounting ø25/52	19T 26T	
51501	85.96210.0012 85.96210.0007 81.96210.0012	Cabin Mounting ø22.5/ø94	12.155 STAR 266M-STAR 8.125 STAR L 2000 M 2000	

Auger Nr.	OEM Nr.	Description	Model	Picture	
51503	81.96210.0462	Cabin Mounting	266M-STAR	TGA	
	81.96210.0369	ø14xø30x48	AGGREGATE ECT18/26 F 2000 F 90 L 2000 M 2000 ÖAF	TGL TGM	
51505	81.96210.0348	Cabin Mounting	12/14/16/17.170/192		
	81.96210.0340		18.220		
	81.96210.0349	ø22xø58.5x47.5	322/352/402/422/462 FRH LION'S CITY LION'S CLASSIC LION'S COACH M 2000 M 90 RH 353/403/463 SL 18.220/260/280 SUE 223/253/263/313 TGA		
51506	81.96210.0400	Cabin Mounting	F 90		
		ø16xø50x29	ÖAF		
51512	81.96210.0353	Cabin Mounting	14/15220/15240		
			16/17220/240/19240		
			16/19281/291/321/331/361		
			22/24/25/26220/240/281/291/321/331/361		
			26/30/32/33/34281/291/321/331/361		
			26/32.365		
			27/32/33/34281/291/321/331/361		
53093	85.96210.0019	Cabin Mounting	ECT18/26		
			TGA		
		ø16.5x60x63.5x80			
53094	85.96210.0021	Cabin Mounting	ECT18/26		
			TGA		
			TGL		
			TGM		
		ø16xø53x58			

Auger Nr.	OEM Nr.	Description	Model	Picture
53275	81.96210.0316 81.96210.0274	Cabin Mounting ø20/153	6/8.90 8/9.136 G 90 ÖAF	
53279	81.96210.5011	Cabin Mounting ø20/83	19.240 26.240/281/301/321 32.240/281/301/321	
55107	81.62158.5021 81.62158.0048 81.96020.0413	Cabin Mounting 98x120x23.5	TGS TGA TGX ECT 18/26T TGL TGM	
55108	85.96210.0020	Cabin Mounting ø22.5/95	L 2000 M 2000	
55109	85.96210.0030	Cabin Mounting ø14/96.5	TGL TGM	
55110	85.96210.0002	Cabin Mounting ø47.5/93	L 2000	
53277	85.41715.0006	Cabin Bushing ø16.5/ø30x29	ECT18/26 TGA	

Type-1



Type-2









Type-3









Auger Nr.	O.E.M. Nr.	A	B	C	Type	Repair Kit
53079	81.96101.0638	ø32	ø70	4	1	51514-51515-52631
54783	81.96503.0129	ø36.5	ø47	4.5	1	51514-51515
54785	85.96501.0002	ø48	ø65	11.5	1	53290
54784	85.90710.0014	25.5	ø79.5	7.5	2	53288-53290
53077	06.36950.0510 - 81.93430.0008 81.93430.0009 - 81.93430.0010	ø30	ø47	22	3	51514-51515-52631-52783
53917	06.36950.0210	ø30	ø47	22	3	53290
55261	81.93430.0016	ø35	ø57	25	3	55125

Auger Nr.	OEM Nr.	Description	Model	Picture
51514	81.96210.0407 S1	Rep. Kit for Cabin ø16.5xø70.5x68	F 2000 F 90 M 2000 ÖAF	
51515	-	Rep. Kit for Cabin ø16xø64x29	F 90 ÖAF	
52631	81.96210.0407 S	Rep. Kit for Cabin ø16.5xø70.5x68	F 2000 F 90 M 2000 ÖAF	







Auger Nr.	OEM Nr.	Description	Model	Picture
52783	81.96210.0400 S	Rep. Kit for Cabin ø16xø50x29	F 90 ÖAF	
53288	81.41715.6014	Rep. Kit for Cabin ø16.5x63.5x60x80	ECT18/26 TGA	
53290	81.41715.6013	Rep. Kit for Cabin ø16.5x63.5x60x80	ECT18/26 TGA	
54634	85.96020.0004 S	Rep. Kit for Cabin ø22xø52.5x42	TGA TGS TGX TGL TGM ECT 18/26 T	
55125	81.41700.6096	Rep. Kit for Cabin ø35xø57x22/25	F 2000 ÖAF	
55126	-	Rep. Kit for Cabin	TGL TGM	

Auger Nr.	OEM Nr.	Description	Model	Picture
20051	81.41722.6048	Cabin Shock Absorber, With Air Bellow Sachs Type	F 2000	
	81.41722.6051			
		ø14xø44.5		
20052	81.41722.6052	Cabin Shock Absorber, With Air Bellow Sachs Type	F 2000 M 90 M2000	
	81.41722.6049			
		ø14xø44.5		
20102	85.41722.6008	Cabin Shock Absorber, With Air Bellow Sachs Type	TGA	
	85.41722.6014			
	85.41722.6022			
	85.41722.6009			
	85.41722.6015			
	85.41722.6023			
		ø12xø44.5		
20104	81.41722.6058	Cabin Shock Absorber, With Air Bellow Sachs Type	TGS TGX TGA TGL TGM ECT 18/26T	
	85.41722.6007			
	85.41722.6013			
	85.41722.6024			
		ø12xø44.5		
20113	81.41722.6057	Cabin Shock Absorber, With Air Bellow Sachs Type	TGS TGX TGA ECT 18/26 T	
	85.41722.6006			
	85.41722.6012			
		ø12xø44.5		
20080	81.41722.6057	Shock Absorber for Cabin	Serie16 / 27 Rear Connection: O / I	
	85.41722.6012			
	85.41722.6006			
		C/O L. 250 / 300		
20081	81.41722.6010	Shock Absorber for Cabin	Serie16 / 27 Rear Connection: O / O	
	81.41722.6013			
	81.41722.6015			
	81.41722.6017			
	81.41722.6045			
		C/O L. 250 / 300		

Auger Nr.	OEM Nr.	Description	Model	Picture
51393	81.43704.0025	Stabilizer Plastic Bearing ø55xø65x80.5	12.170/192 - 14/15.220 15/19/26/32.240 16.200/240/280/290/360/372 16/17.170/192/220/240 16/19.281/291/321/331/361 22/24/25/26.220/240 22/24/25/26/27/32/33/34.281/291/ 321/331/361 26/30/32/33/34.281/291/321/331/ 326/32.301/365 M 90	
51394	81.43704.0026	Stabilizer Plastic Bearing ø38xø58x74	16.200/240 /280/290/360/372 16/19.281/291/321/331/361 22/24/25/26.281/291/321/331/361 26/32.281/301/321 26/27/32/33/34.281/291/321/331/361 30/32/33/34.281/291/321/331/361 22/24/25/26.220/240 14/15.220/15.240 16/17.220/240 19.240 H 26/32.240 - 26/32.365 19T 16/17.220/240/19.240	
51395	81.43704.0029	Stabilizer Plastic Bearing ø45xø58x80	ÖAF - M 90 - M 2000 - G 90 26/32/33/34.281/291/321/331/361 26/32.240/281/301/321/365 22/24/25/26/27/32/33/34.281/291/ 321/331/361 22/24/25/26.291/331/361 16/19.281/291/321/331/361 16/17/22/24/25/26.220/240 16.200/240/280/290/360/372 15/19.240 - 14/15.220 12/16/17.170/192	
51396	81.43704.0032	Stabilizer Plastic Bearing ø60xø70x81	14/15.220/15.240 16/17.220/240 16/19/22/24/25/26/30/32/33/ 34.281/291/321/331/361 22/24/25/26.220/240/291/331/ 361 F90	
54049	06.11241.0317 06.11240.0317 06.11240.2117	Lock Nut M16x1.5/16	-	
54803	85.41312.0002	U-Bolt M10x1.5	L2000 M2000	
52795	-	Stabilizer Bearing Kit	6/8.90 8/9.136/170 G 90 L 2000 M 2000	 <p>54803 51434 51483</p>

Auger Nr.	OEM Nr.	Description	Model	Picture
55136	-	Stabilizer Bearing Kit	M 2000 L 2000	
55137	-	Stabilizer Bearing Kit	12.220 M 2000 L 2000	
55138	-	Stabilizer Bearing Kit	M 2000 L 2000	
55139	-	Stabilizer Bearing Kit	F 90 M 2000 L 2000	
55140	-	Stabilizer Bearing Kit	22/24.330-420 24.310/350/400/460 CENTROLINER F 2000 F 90 L 2000 LION'S COACH LION'S STAR M 2000 M 90 ÖAF TOURLINER UEL 42/272/292/312/313/322/353	
55141	81.43722.0047 S ø24xø64x44	Stabilizer Bearing Kit	12/14220 18.220/230/250/280/310/313/350/360/370/400/ 410/420/460 24.310/350 28.270 AGGREGATE EL 200/222/262 LION'S CLASSIC ND 202 NEWFLYER NG 232/235/252/262/272/312 NGT 204 NL 202/205/213/222/232/240/250/252/262/312 NMT 222 SG 28.280/310 SL 18.220/260/280 SUE 223/253/263/313 UEL 242/272/292/312/322	

Auger Nr.	OEM Nr.	Description	Model	Picture
55142	81.43722.0047 S1	Stabilizer Bearing Kit ø24xø64x44	12/14.220 18.220/230/250/280/310/313/350/360/370/ 400/410/420/460 24.310/350 28.270 AGGREGATE EL. 202/222/262 LION'S CLASSIC ND 202 NEW FLYER NG 232/235/252/262/272/312 NGT 204 NL 2/205/213/222/232/240/250/252/262/312 NMT 222 SG 28.260/310 SL 18.220/260/280 SUE 223/253/263/313 UEL 242/272/292/312/322	
55143	-	Stabilizer Bearing Kit	13.210/220/230 F 2000 F 90 L 2000 M 2000 M 90 NMT 222 ÖAF TGA	
55144	81.96210.0150 S	Stabilizer Bearing Kit ø32xø55x72	16.240/280/281/290/291/321/331/360/ 361/370/372 19.281/291/321/331/361 22/24/25/26.220/240/281/291/321/331/ 361 L 2000 M 2000	
55145	-	Stabilizer Bearing Kit	22/24/25/26.291/331/361 F 2000 F 90 ÖAF TGA	
55146	-	Stabilizer Bearing Kit	16/19.281/291/321/331/361	
55147	-	Stabilizer Bearing Kit	14/15.220 16/17/22/24/25/26.220/240 16/19.281/291/321/331/361 M 90 ÖAF	

Auger Nr.	OEM Nr.	Description	Model	Picture
55148	-	Stabilizer Bearing Kit	322/352/402/422/462 FRH ECT18/26 F 2000 LION'S CITY LION'S COACH ND 313/363 RH 353/403 TGA	
55149	-	Stabilizer Bearing Kit	12.220 14.220/280 TGA TGM	
55150	-	Stabilizer Bearing Kit	TGA F 2000	
55151	-	Stabilizer Bearing Kit	TGA TGM F 2000	
55152	-	Stabilizer Bearing Kit	F 2000 L 2000 ÖAF TGA TGM	
55153	-	Stabilizer Bearing Kit	F 2000 ÖAF	

Auger Nr.	OEM Nr.	Description	Model	Picture
51403	81.43271.0080	Silent Block for Stabilizer ø65.5xø15/100	18.220/290/370 F 2000 F 90 M 90 ÖAF	
51404	81.43271.0082	Silent Block for Stabilizer ø65.5xø21/125	14/ 15.220 15/ 19.240 16.200/ 220/ 240/ 280/ 290 16/ 19.281/ 291/ 321/ 331/ 361 17.220/ 240 26/ 32.240/ 281/ 291/ 301/ 321/ 331/ 361/ 365 27/ 32/ 33/ 34.281/ 291/ 321/ 331/ 361 30/ 32/ 33/ 34.281/ 291/ 321/ 331/ 361 F 2000 F 90 ÖAF TGA	
51405	81.43271.0083 81.43271.0079 81.43271.0046	Silent Block for Stabilizer ø75xø21/125	F 2000 F 90 ÖAF	
51406	81.43271.0087	Silent Block for Stabilizer ø65.5xø19/130	16.240/280/290/360/370/372 22/24.330-420 ÖAF	
51407	81.43271.0078 81.43271.0032	Silent Block for Stabilizer ø75xø19/130	14.220 15/16/17/22/24/25/26.220/240 16/19.281/291/321/331/361 22/24/25/26/30/32/33/34.281/291/ 321/331/361	
51415	81.96210.0452	Silent Block for Stabilizer ø47.5xø19/99	10/11.150/180/190/220/230 12.220 L 2000 M 2000 M 90	

Auger Nr.	OEM Nr.	Description	Model	Picture	
51416	81.96210.0511	Silent Block for Stabilizer ø47.5xø21/101	10/11.150/180/190/220/230 12.220 L 2000 M 2000 M 90		
53011	81.43722.0072	Silent Block for Stabilizer ø68.5xø15/100	F 2000 TGA		
51391	81.43722.0039	Stabilizer Mounting ø22xø67.5x62	F 2000 F 90 L 2000 M 2000 M 90 ÖAF TGA		
51392	81.43722.0063	Stabilizer Mounting ø22xø68x62	12.220 13.210/220/230 14.220/280 ECT18/26 F 2000 F 90 L 2000	M 2000 M 90 NMT 222 ÖAF TGA TGM	
51432	81.96210.0450 81.43722.0038 81.96210.0469	Stabilizer Mounting ø16xø47.5x47	G 90 L 2000 LION'S CITY LION'S CLASSIC M 2000 M 90 ND 313/363 NG 243/263/313 NL 223/242/243/263/283/313 NMT 222 - NUE 263/313/353 ÖAF - RH 353/403 SG 28.260/310 SL 18.220/260/280 SUE 223/253/263/313 UEL 242/272/292/312/322		
53018	81.43722.0059	Stabilizer Mounting ø16xø50x47	322/352/402/422/462 FRH 18.220/260/280/290/310/313/350/360/370/ 400/410/420/460 22/24.330-420 - 24.310/350/400/460 - 26T CENTROLINER - ECT18/26 - F 2000 - F 90 L 2000 LION'S CITY - LION'S COACH LION'S REGIO - LION'S STAR M2000 - M90 - ND 313/363 NG 243/263/313 NL 223/242/243/263/283/313 NM 223/283 - NUE 263/313/353 ÖAF - RH 353/403/463 STARLINER - TGA - TGL - TGM TOURLINER - TRENDLINER UEL 242/272/292/312/313/322/353		

Auger Nr.	OEM Nr.	Description	Model	Picture
53054	81.43722.0047	Stabilizer Mounting ø24xø64x44	12/14.220 18.220/230/250/280/310/313/350/360/ 370/400/410/420/460 24.310/350 - 28.270 LION'S CLASSIC - ND 202 NG 232/235/252/262/272/312 NGT 204 NL202/205/213/222/232/240/250/252/ 262/312 NMT 222 SG 28.260/310 - SL 18.220/260/280 SUE 223/253/263/313 UEL 242/272/292/312/322	
53012D	81.43704.0077	Stabilizer Mounting ø50xø75x51	12.220 14.220/280 18.220/260/280/310 CENTROLINER ECT26 L 2000 LION'S CITY ND 313/363 NG 243/263/313 NL 223/242/243/263/283/313 NUE 263/313/353 TGA TGL TGM	
51433	81.43722.0040 81.43722.0041 81.43722.0042	Stabilizer Mounting ø55xø83x70	12/14.220 M 90 13.210/220/230 NMT 222 26T ÖAF F 2000 TGA F 90 TGL L 2000 M 2000	
52950D	81.43704.0078	Stabilizer Mounting ø45xø75x51	18.260/310/313/350/360/370/400/410/420/460 322/352/402/422/462 FRH ECT18/26 - F 2000 LION'S CITY - LION'S COACH - LION'S REGIO -LION'S STAR ND313/363 - NM223/283 RH353/403 STARLINER - TOURLINER - TRENDLINER UEL313/353 - TGA	
53266	81.43722.0083	Stabilizer Mounting ø60xø88x60	ECT18/26 F 2000 TGA TGM	
53269	81.43722.0068 81.43722.0069 81.43722.0080	Stabilizer Mounting ø50xø84x72	F 2000 L 2000 ÖAF TGA TGM	

Auger Nr.	OEM Nr.	Description	Model	Picture
53270	81.43704.0074	Stabilizer Mounting ø45xø65x51	18.220/260/290/310/313/350/360/ 370/400/410/420/460 26T F 2000 M 2000 ÖAF	
55106	81.43704.0079	Stabilizer Mounting ø42xø75x51	TGS TGA ECT 18 TGM	
55116	85.43722.0007	Stabilizer Mounting ø14xø42.5x35	TGL TGM	
53116	81.95301.0048	Stabilizer Mounting ø83/46	GS UEH 270/290/320/370 MAN 292/332/362 SG 242/282/292/322 SL 202 SR 240/280 SUE 240/242/280	
52949	81.43722.0052	Stabilizer Mounting ø34.5xø55x60	L 2000 M 2000	
52951	81.43722.0053	Stabilizer Mounting ø39xø55x60	12.220 14.280 L 2000 M 2000	

Auger Nr.	OEM Nr.	Description	Model	Picture
51410	81.43271.0033	Stabilizer Mounting ø55xø75x83	SG 242/280/282/292/322 SL 200/ 202 SR 280 SUE 240/242/280	
51411	81.43271.0074 81.43271.0056	Stabilizer Mounting ø42xø68x68	SL 200 SR 240/280 SUE 240/280	
51412	81.43316.0021	Stabilizer Mounting ø55xø75x83	322/352/402/422/462 FRH 16.360/372 22/24.330-420 24.400/460 GS UEH 270/290/320/370 SG 242/280/292/322 SL 200/202 SUE 240/242/280	
51413	81.44204.0012 81.44204.0004	Stabilizer Mounting ø42xø68x68	-	
51414	81.44204.0021 81.44204.0020	Stabilizer Mounting ø58xø80x68	322/352/402/422/462 FRH 16.360/372 22/24.330-420 24.400/460 GS UEH 270/290/320/370 LION'S COACH MAN 292/332/362 SG 242/280/282/292/322 SL 200/202 SR 240/280 SUE 240/242/280	
55105	85.43704.0005	Stabilizer Mounting ø26x46x66	TGL	

Auger Nr.	OEM Nr.	Description	Model	Picture
51389	81.43704.0053	Stabilizer Bearing ø35.5xø56.5x51.5	6/8.90 8/9.136 8/9.136/170 G 90 L 2000 M 2000	
51390	81.43704.0052	Stabilizer Bearing ø31.5xø56.5x51.5	6/8.90 F/FR G 90 L 2000	
53278	81.43704.0038	Stabilizer Bearing ø39xø56.5x51.5	6/8.90 8/9.136/170 G 90 L 2000 M 2000	
51434	81.96210.0278	Stabilizer Bearing ø27x50.5	6/8.90 8/9.136/170 G 90 L 2000 M 2000	
51453	81.96020.0286	Stabilizer Rubber Bushing ø14xø37.5x51	6/8.90 F/FR 8/9.136/170 G 90 L 2000 M 2000	
51483	81.96210.0294	Stabilizer Rubber Bushing ø12xø33.5x32	6/8.90 8/9.136/170 G 90 L 2000 M2000	







Auger Nr.	OEM Nr.	Description	Model	Picture
53971	81.43722.0022	Stabilizer Rubber Bushing ø16xø45x47	10/11.150/180/190/220/230 - 12.220 13.210/220/230 - 14.220/280 16.200/240/280/290/360/370/372 18.220/260/280/310/313/350/360/370/400/ 410/420/460 22/24.330-420 24.310/350/400/460 26/32/33/34.281/291/321/331/361 - 26T 322/352/402/422/462 FRH CENTROLINER ECT18/26 F2000 TGA TGL TGM F90	
51408	81.43722.0019 81.43722.6051	Stabilizer Rubber Bushing ø22xø75x62	22/24/25/26.291/331/361 F 2000 F 90 ÖAF TGA	
51409	81.43722.0021	Stabilizer Rubber Bushing ø22xø65.5x62	22/24/25/26.291/331/361 F 2000 M 90 ÖAF	
51417	81.43271.0029 81.43271.0008	Stabilizer Rubber Bushing ø16xø45x42	12/14/16.170/192 14/15.220 15/19/26/32.240 16.240/280/290/360/372 16/17/22/24/25/26.220/240 16/19.281/291/321/331/361 22/24/25/26/27/30/32/33/34.281/ 291/321/331/361 M 90	
51418	81.43271.0022	Stabilizer Rubber Bushing ø18xø55x55	-	
53019	81.96210.0150	Stabilizer Rubber Bushing ø32xø55x72	16.240/280/281/290/291/321/331/ 360/361/370/372 19.281/291/321/331/361 22/24/25/26.220/240/281/291/321/ 331/361 L 2000 M 2000	

Auger Nr.	OEM Nr.	Description	Model	Picture
51126	81.43271.0081	Stabilizer Half Bushing ø54xø93.5/70x80	16.240/280/290/360/372 18.220/290/370 22/24.330-420 26T F 2000 F 90 ÖAF	
51397	81.43704.0057	Stabilizer Half Bushing ø44.5xø67x60	10/11.150/180/190/220/230 12.220, 13.210/220/230 16.200/240/280/290/360/370/372 18.310/350/360/370/400/410/420/460 22/24.330-420 24.310/350/400/460 CENTROLINER F 2000, F 90, L 2000 LION'S CITY, LION'S CLASSIC LION'S COACH, LION'S STAR M 2000, M 90 MAN 322/352/402/422/462 FRH ÖAF RH 352/353/402/403/422/463 SG 28.260/310 SUE 223/253/263/313 TOURLINER UEL 242/272/292/312/313/322/353	
51398	81.43704.0060	Stabilizer Half Bushing ø55xø78x60	14.280 22/24/25/26.291/331/361 F90 L 2000 M 2000	
51399	81.43704.0061	Stabilizer Half Bushing ø60xø78x60	14.280 18.220/290/370 22/24/25/26.291/331/361 ECT18/26 F 2000 F 90 L 2000 M 2000 ÖAF TGA	
51401	81.43704.0044 81.43704.0042	Stabilizer Half Bushing ø55xø82x80	SL 200 SR 280 SUE 240 SR 240/280	
51402	81.43704.0045 81.43704.0028	Stabilizer Half Bushing ø55xø87x80	SL 200 SR 240/280 SUE 240	



Auger Nr.	O.E.M. Nr.	A	B	C	Type	Repair Kit
54820	06.33719.0057	ø42	ø52	20	1	53008
53078	06.36959.0014 - 06.36959.0011 06.36959.0018 - 81.93430.0004	ø42	ø62	25	2	51375-51376
54895	81.93020.0576	ø30	ø34	42	3	51373
54015	81.93021.0117 - 81.93021.0141 81.93021.0142 - 81.93021.0311	ø30	ø34	48	3	-
54839	06.56279.0310	ø40.5	ø58	7	4	51375-51376
54840	06.56279.0297	ø40.5	ø55	9	4	51375-51376
54871	06.56279.0262	ø41	ø52	5	4	53008
54793	81.50212.0036	ø30	102	-	5	51373

Auger Nr.	OEM Nr.	Description	Model	Picture
51375	81.51901.6005	Rep. Kit for Camshaft ø42	322/352/402/422/462 FRH 33/34.281/291/321/331/361 EL_202/222/262 F 2000 F 90 L 2000 M 2000 M 90 LION'S CLASSIC MAN 292/332/362 ND/NG/GS/NGT/NL/NM/SL/SD/SG/SUE/ UEL/ÖAF	
51376	06.36959.0014 S	Rep. Kit for Camshaft ø42	322/352/402/422/462 FRH 33/34.281/291/321/331/361 EL_202/222/262 F 2000 F 90 L 2000 M 2000 M 90 LION'S CLASSIC MAN 292/332/362 ND/NG/GS/NGT/NL/NM/SL/SD/SG/SU EUEL/ÖAF	
53008	81.51901.6006	Rep. Kit for Camshaft ø42	322/352/402/422/462 FRH 33/34.281/291/321/331/361 EL 202/222/262 - F 2000 - F 90 M 2000 - M 90 - L 2000 LION'S CLASSIC - MAN 292/332/362 ND/NG/NGT/NL/NM/SD/SG/SL/GS/SL /SUE/UEL/ÖAF	
51373	81.50212.0036 S	Rep. Kit for Brake Shoe ø30	10/11.150/180/190/220/230 14.170/192 - 14/15.220/15.240 F 2000 - F 90 - L 2000 - TGA - ÖAF GS UEH 270/290/320/370 LION'S CITY - LION'S CLASSIC LION'S COACH - NEW FLYER M 2000 - M 90 - ND 202 MAN 292/332/362	

Auger Nr.	OEM Nr.	Description	Model	Picture
53919	81.50213.6006 S	Rep. Kit for Brake Shoe ø20	LION'S CLASSIC ÖAF M 2000 M 90 NEW FLYER TGA L 2000 F 2000 F 90	
55123	81.97610.0224	Rep. Kit for Brake Shoe	10/11.150/180/ 14.280 190/220/230 12.220 12.170/192 NMT 222 14.170/192 G 90 8/9.136 L 2000 8.136 M 2000 13.220 M 90 13.210/220/230 12/14.220	
55124	81.97610.6013 81.97610.6005	Rep. Kit for Brake Shoe	G 90 L 2000	
53283	81.97610.0271 81.97610.0266	Brake Shoe Spring ø30x240	16.200/220/240/280/281/290/291/321/ 331/360/361/370/372 17.220/240 18.310/350/370/400/420/460 19.240/281/291/321/331/361 22/24.330-420 - 22/24/25/26.291/331/361 24.310/350/400/460 26/32.240 - 26/32.281/301/321/365 F 2000 - F 90 - L 2000 - M 2000 - M 90 TGA ÖAF	
53901	81.97610.0208 81.97610.0118 81.97610.0317	Brake Shoe Spring ø26x243	14.170/192/220 - 15.220/15.240 ... 34.281/291/321/331/361 F 2000 F 90 L 2000 M 2000 M 90 ÖAF - SL 200 - SUE	
53902	81.97610.0115 81.97610.0123	Brake Shoe Spring ø26x234	14.220 15.220/240 30.281/291/321/331/361 322/352/402/422/462 FRH EL 202/222/262 F 2000 LION'S CITY LION'S CLASSIC NEW FLYER	

Auger Nr.	OEM Nr.	Description	Model		Picture
53984	81.97610.0001	Return Spring ø27x210	14.220 - 15.220/240 16.200/220/240/280/281/290/291/321 17.220/240 19.281/291/321/331/361 19/26/32.240 22.220/240/281/291/321/331/361 22/24.330-420 24.220/240/281/291/321/331/361 25.220/240/281/291/321/331/361 26.220/240/281/291/301/321/331 27/30/33/34.281/291/321/331/361 32.281/291/301/321/331/361/365		
55102	81.97610.0265	Brake Shoe Spring ø26x245	TGS TGX F 2000 F 90 TGA L 2000	M 90 M 2000 TGM	
55096	81.50211.0018 81.50211.0028 83.50211.0000	Brake Shoe Spring Pin ø12x72	F 2000 F 90 L 2000 TGA TGS TGX		
55097	81.50211.0027 81.50211.0016	Brake Shoe Spring Pin ø12x95	F 2000 F 90 L 2000 M 90 M 2000		
54015	81.93021.0117 81.93021.0141 81.93021.0142 81.93021.0311	Brake Shoe Bushing ø30xø34x48	LION'S CITY LION'S CLASSIC LION'S COACH NEW FLYER M 2000 M 90 F 2000	F 90 L 2000 TGA TGM ÖAF	
51421	81.96210.0132	Rubber Buffer for Brake Pressure Regulator M10/ø50x45	18.220/290/370 - 26/32.240/281/291/301/321/331/3 61/365 27/30/32/33/34.281/291/321/331/ 361 - ÖAF		
53281	81.50101.5141 81.50101.5142	Dust Cover, Phosphated & Painted ø265xø452x40	18.220/230/250/290/310/313/350/ 370/400/420/460 - 19T 24.350/400 - 28.270 F 2000 - F 90 - L 2000 - M 2000 M 90 - ÖAF LION'S CLASSIC NEW FLYER SG 28.260/310 SL 18.220/260/280 SUE 223/253/263/313 UEL 242/272/292/312/322		

Auger Nr.	OEM Nr.	Description	Model	Picture
31017	81.50803.0009 81.50803.0014	Brake Disc 200x438xM16X1,5	UEL 313/353 / FORTUNA NL 202/213/222/250/262/312- PODESTLOS NG 252/262/272/312-PODESTLOS	
31018	81.50803.0040	Brake Disc 196x432	LION'S COACH UEL 313/353 LION'S CITY NL 223 KVB /263/313 NG 263/313 LION'S CLASSIC SL 18.220/260/280 SG 28.260/310 SUE 223/253/263/313 LION'S REGIO	
31019	81.50803.0041	Brake Disc 208x432	UEL 313/353 LION'S CITY NL 223/242/243/263/313 NG 243/263/313 LION'S CLASSIC SL 18.220/260/280 SUE 223/253/263/313 LION'S STAR LION'S COACH LION'S REGIO	
31020	81.50803.0026	Brake Disc 135x330xM14X1,5	MAN 12.153 / 12.163	
31021	81.50803.0010	Brake Disc 135x324xM14X1,5	MAN L 2000 8.224 / 9.223 / 10.223	
31022	81.50803.0022	Brake Disc 157x330xM12X1,5	MAN L 2000 8.224 / 9.223 / 10.223 / 12.163	

Diaphragms - Normal Stroke

Auger Nr.: 52576

O.E.M. Nr. —

Type 9"

Auger Nr.: 52578

O.E.M. Nr. —

Type 12"

Auger Nr.: 52580

O.E.M. Nr. —

Type 16"

Auger Nr.: 52581

O.E.M. Nr. —

Type 20"

Auger Nr.: 52582

O.E.M. Nr. —

Type 24"

Auger Nr.: 52583

O.E.M. Nr. —

Type 30"

Auger Nr.: 52584

O.E.M. Nr. —

Type 36"



Diaphragms - Long Stroke

Auger Nr.: 52585

O.E.M. Nr. —

Type 16"

Auger Nr.: 52586

O.E.M. Nr. —

Type 20"

Auger Nr.: 52587

O.E.M. Nr. —







Type 24"

Auger Nr.: 52588

O.E.M. Nr. —

Type 30"



Auger Nr.	OEM Nr.	Description	Model	Picture
21010	-	Service Brake Chamber for drum brake 112.5/126xM16x1.5x164	T16 STR 75	
21011	81.51101.6172 81.51101.6173 81.51101.6174 81.51101.6175 81.51101.6198 81.51101.6221 81.51101.6222 81.51101.6223 81.51101.6225 81.51101.6249 81.51101.6260 81.51101.6266 81.51101.9249	Service Brake Chamber for drum brake with repair kit 112.5/353xM16x1.5x164	T16 STR 75	
21012	-	Service Brake Chamber for drum brake 113/126xM16x1.5x174	-	
21013	81.51101.6076 81.51101.6077 81.51101.6078 81.51101.6079 81.51101.6199 81.51101.9076	Service Brake Chamber for drum brake with repair kit 113/353xM16x1.5x174	T20 STR 75	
21014	-	Service Brake Chamber for drum brake 112.5/126xM16x1.5x186	T24 STR 75	
21015	81.51101.6080 81.51101.6081 81.51101.6082 81.51101.6083 81.51101.6105 81.51101.6111 81.51101.6115 81.51101.9105	Service Brake Chamber for drum brake with repair kit 112.5/353xM16x1.5x186	T24 STR 75	

Type-1



Type-2



Type-3



Type-4



Auger Nr.	O.E.M. Nr.	A	B	C	Type	Repair Kit
54842	06.56279.0353 - 06.56279.0354 - 06.56279.0355 06.56279.0274 - 06.56279.0273 - 81.96501.0749	ø49	ø58	4	1	52603-52615 53006-54205
54846	06.56279.0291 - 06.56279.0290 - 06.56279.0292 06.56279.0356 - 81.96502.6089	ø34	ø42	4	1	52562-53005 53286
54847	06.56269.0598 - 06.56269.0599 - 06.56269.0597-81.96502.6060	ø29	ø37	4	1	52563
54867	81.96501.0750	ø44	ø52	4	1	52564
54868	06.56279.0284 - 06.56279.0285 - 06.56279.0288 - 81.96502.6058	ø37	ø45	4	1	52565
54889	06.56279.0289 - 06.56279.0287 - 06.56279.0286 - 06.56279.0357 81.96502.6059 - 81.96502.6088	ø41	ø49	4	1	54206-55128 55129
54891	06.56279.0343	ø54	ø62	4	1	55132
54873	06.56279.0025	ø56	ø75	7.5	2	53186-55131
54874	06.56279.0181 - 06.56279.0026	ø63	ø80	16	2	53187-55131
54890	81.96503.0320 - 81.96503.0516	ø52.5	ø78	10	3	54207-55133
55268	81.96503.0434	ø42.5	ø65.5	10	3	55127
55269	81.96503.0392	ø38.5	ø61	9	3	55130
55244	06.56279.0031 - 06.56279.0080 - 81.96502.6017 - 87.66169.2801	ø49	ø70	14.5	4	55131
55245	06.56279.0029 - 87.66160.2882	ø49	ø70	8	4	55131

Type-1

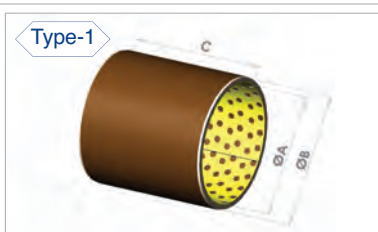





Type-2

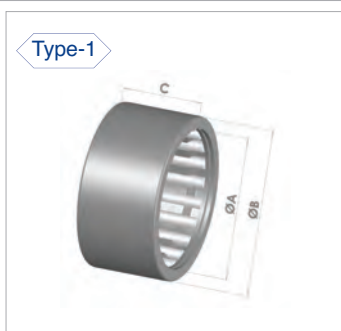

Auger Nr.	O.E.M. Nr.	A	B	C	Type	Repair Kit
54612	81.93020.0707 - 81.93020.0511 - 81.93020.6006	ø45	ø52	48	1	52564
54613	81.93020.0708 - 81.93020.0510 - 81.93020.6005	ø44.5	ø52	48	1	52564
54614	81.93021.0278	ø36	ø42	33	1	53005
54620	81.93021.0277	ø43	ø49	40	1	54206
54900	81.93020.0706 - 81.93020.0512 - 81.93020.6007	ø49.5	ø58	52	1	52603-52615-54205
54901	81.93021.0138 - 81.93021.0048	ø29.5	ø37	30	1	52563
54519	81.93020.0482 - 81.93020.0459	ø50	ø57	45	1	53186-55131
54520	81.93020.0460	ø50	ø57	50	1	53187-55131
54603	81.93021.0139 - 81.93021.0049	ø34.5	ø42	33	1	52562-53286
54607	81.93020.0705 - 81.93020.0513 - 81.93020.6008	ø50	ø58	52	1	52615
54905	81.93021.0173 - 81.93021.0050	ø37.5	ø45	37	1	52565
54907	81.93021.0279	ø51	ø58	52	1	53006
55270	81.93021.0051	ø41.5	ø49	40	1	55128-55129
55271	81.93021.0270	ø55	ø62	50	1	55132
55259	81.93021.0416	ø43	ø50	37.5	2	55127
55260	81.93021.0410	ø39	ø46	31.5	2	55130

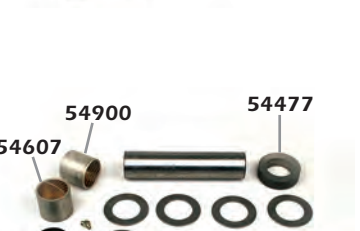
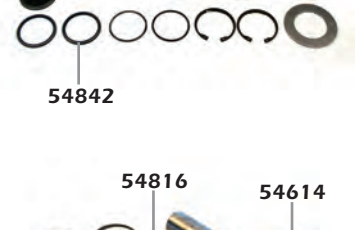

Auger Nr.	O.E.M. Nr.	A	B	C	Type	Repair Kit
54480	06.33719.0067	ø50	ø58	25	1	52603-53006-54205
54590	06.33719.0081	ø30	ø37	16	1	52563
54816	06.33719.0082 - 06.33719.0086 - 81.93402.6008	ø35	ø42	20	1	52562-53005-53286
54818	06.33719.0073 - 06.33719.0076 - 81.93402.6004	ø45	ø52	22	1	52564
54819	81.93402.6005 - 06.33719.0083 - 06.33719.0087	ø38	ø45	20	1	52565
54821	06.33719.0084 - 06.33719.0088 - 81.93402.6006	ø42	ø49	20	1	54206-55128-55129
54822	06.33719.0101	ø53	ø60	27	1	54207-55133
54825	06.33719.0098 - 06.33719.0097 - 06.33719.0099	ø54	ø62	27	1	55132
55229	06.33019.0047 - 06.33019.0046 81.93401.0016 - 81.93401.0026	ø50	ø65	25	1	55131
54477	06.32819.0033 - 06.32819.0017 06.32839.0019 - 81.44210.0020 - 06.32579.0057 81.93420.0301 - 06.32819.0004 - 06.32819.0008 06.32579.0016 - 06.32579.0036 - 81.44210.0017	ø50.25	ø78	22	2	52603-52615 53006-54205
54494	06.32819.0016 - 06.32579.0037 06.32579.0056 - 81.44210.0016	ø45.1	ø74	20	2	52564
54587	06.32819.0034 - 06.32819.0027 - 06.32819.0024 06.32819.0021 - 06.32819.0011 - 06.32819.0071	ø35.2	ø55.55	14	2	52562-53005-53286
54588	06.32819.0026 - 06.32819.0010 - 06.32819.0019 06.32819.0022 - 81.93420.0069 06.33719.0085 - 81.93402.6007	ø30.1	ø50	12	2	52563
54592	06.32819.0030 - 06.32819.0028 - 06.32579.0058	ø38.1	ø62	14	2	52565
54598	06.32819.0035 - 06.32579.0059 06.32819.0029 - 06.32819.0031	ø42.5	ø67.8	17	2	54206-55128-55129
55267	06.32839.0017 - 06.32839.0016 - 06.32839.0018	ø54	ø82	22	2	55132
54823	81.93404.0065	ø52	ø60.6	77	3	54207
55262	81.93404.0068	ø42	ø50.5	63.5	3	55127
55263	81.93404.0064 - 81.93404.0063	ø38	ø46.5	55.5	3	55130
55264	81.93404.0066	ø52	ø60.5	77	3	55133

Auger Nr.	OEM Nr.	Description	Model	Picture
52562	81.44205.6016	King Pin Set ø34.5/ø35x174.5	G 90	
52563	81.44205.6024	King Pin Set ø29.5/ø30x156	L 2000	
52564	81.44205.6009	King Pin Set ø44.5/ø45x213	14.170/192/220 15.220/240 16.170/192/220/240/281/291/321/331/361 17.170/192/220/240 19/30/33/34/281/291/321/331/361 26/32.240/281/291/301/321/331/361 F 90 M 90 ÖAF	
52565	81.44205.6018	King Pin Set ø37.5/ø38x192	10.150/180/190/220/230 11.150/180/190/220/230 12.170/192 13.210/220/230 M 90	
52615	81.44205.6010	King Pin Set ø49.5/ø50x223	16.170/192/200/240/280/281/290/ 291/321/331/360/361/372 17.170/192 19.240/281/291/321/331/361 22.220/240/281/291/321/331/361 24.220/240/281/291/321/331/361 25.220/240/281/291/321/331/361 26.220/240/281/291/301/321 30.281/291/321/331/361 32.240/281/291/321/301/331 33.281/291/321/331/361 34.281/291/321/331/361 SG 280/292 SL 200 SR 240/280 SUE 240/280	
53005	81.44205.6025	King Pin Set ø35/ø36x172	L 2000 M 2000	

Auger Nr.	OEM Nr.	Description	Model	Picture
52603	81.44205.6013	King Pin Set ø49.5/ø50x223	16.170/192/200/240/280/281/290/291/321/331/360/3 61370/372 32.240/281/291/301/321/331/361/365 322/352/402/422/462 FRH F 2000 - F 90 - L 2000 - M 2000 - M 90 - ÖAF LION'S CLASSIC - LION'S COACH NEW FLYER NDNGNGT/NL/NM/SD/SG/SL/SRS/SUE/UEL	
54205	81.44205.6013 S	King Pin Set ø49.5/ø50x223	-	
53006	81.44205.6023	King Pin Set ø50/ø51x223	18.220/230/250/260/280/290/310/ 313/350/360/370/400/410/420/460 F 2000 L 2000 M 2000 ÖAF LION'S CITY - LION'S CLASSIC NG/NL/SG/SL/SUE/UEL / NUE	
53186	81.36305.0015 S	King Pin Set ø50x109	16.170/192 16/17.220/240/19.240 16/19.281/291/321/331/361 26/27/32/33/34.281/291/321/331/361 26/32.240/321 F 2000 F 90 L 2000 M 2000 M 90 ÖAF TGA	
53187	81.36305.0014 S 81.36305.0016 S 81.36305.6001 S	King Pin Set ø50/ø64x119	16.170/192 - 1 6/17.220/240/19.240 16/19.281/291/321/331/361 26/27/32/33/34.291/331/361 26/32.240/281/301/321 F 2000 - F 90 - L 2000 M 2000 - M 90 TGA ÖAF	
53286	81.44205.6020	King Pin Set ø34.5/ø35x174.5	L 2000	

Auger Nr.	OEM Nr.	Description	Model	Picture
54206	81.44205.6027	King Pin Set ø43x200	12/14.220 14.280 L 2000 M 2000 NMT 222	
54207	81.44205.6030	King Pin Set ø53x235	LION'S... CENTROLINER TGA - TGM TOURLINER TRENDLINER ND/NG/NL/NM/NUE/UEL 18.220/260/280/310 ECT18/26	
55127	81.44205.6034	King Pin Set ø43x200	12/14.220 14.280 TGM 12.220	
55128	81.44205.6019	King Pin Set ø41.5/ø42x202	L 2000 M 2000 12.170/192 14.170/192 N 90	
55129	81.44205.6019 S	King Pin Set ø41.5/ø42x202	L 2000 M 2000 12.170/192 14.170/192 N 90	
55130	81.44205.6033	King Pin Set ø38/ø39x173	TGL TGM L 2000	

Auger Nr.	OEM Nr.	Description	Model	Picture	
55131	81.36305.6004	King Pin Set	TGS F 2000 F 90 TGA L 2000 M 90 M 2000 TGM ÖAF	16.170/192 16/19.281/291/ 321331/361 16/17.220/240/ 19.240 SONDER- FAHRZEUGE	
55132	81.44205.6028	King Pin Set ø54/ø54.2/ø55x232	TGS TGX UEL 313/353 LION'S COACH RH 403/463 RH 353/403 TGA ECT 26T	STARLINER CITYLINER TOURLINER TRENDLINER LION'S STAR LION'S REGIO 18260/410/460 24410/460	
55133	81.44205.6031	King Pin Set ø53x235	TGS TGX TGA ECT 26T		
53284	81.93001.0319	Axle Bearing Bushing ø40.5xø44.5x32	F 2000 F 90 L 2000 M 2000 M 90 ÖAF		
51554	81.41401.0036	Axle Buffer ø81.5x332x61		26.281/291/301/321/331/361 32.281/291/301/321/331/361 33.281/291/321/331/361 34.281/291/321/331/361	
51326	81.35710.0094 S 81.35710.0044 S	Thrust Washer (Surface Hardened) ø115xø145x32	19T/26T EL 202/222/262 ND 202 NG 232/235/242/252/262/272/312 NGT 204 NL 202/213/222/232/240/250/ 252/262/312		
51328	81.35710.0093 S 81.35710.0045 S	Thrust Washer (Surface Hardened) ø110xø145x32	16.200/240/280/290/360/370/372 22/24.330 - 420 26.281/291/321/331/361/365 32.281/291/321/331/361/365 EL 202/222/262 F 90 - ND 202 - NGT 204 - SD 202 SL 200 - SR 240/280 SUE 240/280		

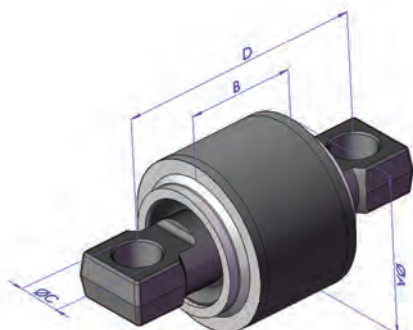

Auger Nr.	O.E.M. Nr.	A	B	C	D
51400	81.43220.6202	ø67	43	ø17	100
54572	81.43220.6197 - 81.95302.0038	ø67	43	ø15	100
54063	81.43220.6108 S	ø72	46.5	ø19	130
51443	81.43230.6061	ø75	48	ø19	130
51445	81.43230.6051 - 81.43230.6068	ø75	48	ø17	115
54188	85.43220.6002	ø75	52	ø19	130
53944	81.43220.6244	ø75	52	ø17	115
53009	81.43230.6043 S	ø80	52.5	ø19	130
51137	81.43220.6107 - 81.43220.6055	ø85	54	ø19	130
51441	81.95302.0077	ø85	57.5	21.5/26	129
51442	81.43270.6105	ø85	57.5	ø25	130
51444	81.43220.6203	ø85	54	ø21	130
53287	81.43220.6250	ø85	57.5	ø19	130
51135	81.43270.6040 - 81.43270.6045	ø95	61	ø21	152
53211	81.43270.6079	ø95	61	ø23	152
53056	81.43315.0009	ø95	54	ø19	145
53289	81.96401.0152	ø95	61	ø19	130
51446	81.43270.6110	ø100	73	ø25	152
55118	81.43220.6285	ø85	57.5	ø25	130
55119	81.43270.6119	ø75	52	ø19	115
55120	81.43270.6133	ø85	57.5	ø21	130
55121	81.43270.6126 - 81.43270.6118	ø85	57.5	ø23	130
54190	81.43270.6127	ø85	57.5	ø19	130
54189	81.43220.6241	ø95	61	ø21	130
51141	81.43270.6097 S	ø85	57.5	ø25	152
55053	81.43270.6097 S1	ø75	52	ø23	130

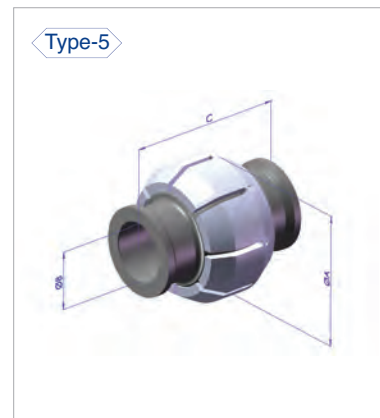
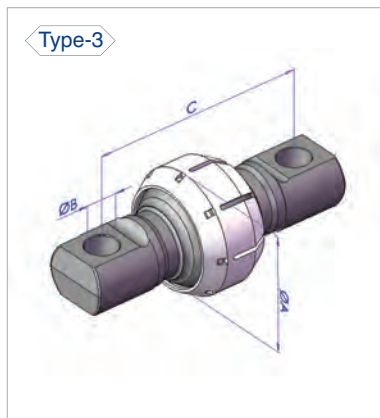
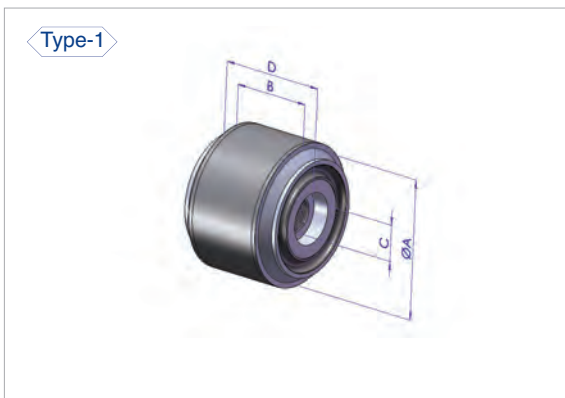

Auger Nr.	O.E.M. Nr.	A	B	C	D	Type
53007	81.43220.6204	ø95	53	M24x2	74	1
54637	81.43230.6060	ø85	54	M36x1.5	248	2
51447	81.43220.6108 - 81.43220.6132 81.43220.6109 - 81.43220.6290	ø72	ø19	130	-	3
55054	81.43220.6322	ø72	ø23	130	-	3
55122	81.43270.6072	ø90	ø23	152	-	3
51448	81.43230.6043	ø80	ø19	130	-	3
51449	81.95301.6133	ø90	ø23	152	-	3
53201	81.43270.6065	ø72	M20x1.5	46	-	4
51450	81.43270.6080 - 81.95301.6132	ø90	M24x1.5	59	-	4
53057	81.43270.6047	ø90	M24x1.5	60	-	4
53010	81.43250.6009	ø46	ø20	60	-	5

Auger Nr.	OEM Nr.	Description	Model	Picture
51135	81.43270.6040 81.43270.6045	Rep. Kit for Axle Rod ø95xø21/152	MAN 292/332/362 SG 242/282/280/292/322 SL 200/ 202 SR 240/280 SUE 240/242/280	
51137	81.43220.6107 81.43220.6055	Rep. Kit for Axle Rod ø85xø19/130	12/14.220-13.210/220/230 322/352/402/422/462 FRH CENTROLINER-LION'S CITY LION'S CLASSIC -LION'S COACH LION'S REGIO-LION'S STAR NEW FLYER - STARLINER TOURLINER - TRENDLINER ND 202/313/363 - NG 232/ 235/242/243/252/262/263/272/ 312//313 NGT 204 NL202/205/213/222/223/232/240/ 242/243/250/262/263/283/312/313 NM 223/283 - NMT 222 NUE 263/313/353 RH 353/403/463 SG 28.260/310 SUE 223/253/263/313 - TGA UEL 313/353	
51400	81.43220.6202	Rep. Kit for Axle Rod ø67xø17/100	L 2000	
51441	81.95302.0077	Rep. Kit for Axle Rod ø85x21.5/26x129	UEL 313/353 MAN 322/352/402/422/462 FRH RH 352/402/403/422	
51442	81.43270.6105	Rep. Kit for Axle Rod ø85xø25/130	ECT18/26 F 2000 ÖAF TGA	
51443	81.43230.6061	Rep. Kit for Axle Rod ø75xø19/130	12/14/18.220 24.310/350 EL 202/222/262 ND 202 NG 232/235/242/252/ 262/272/312 NGT 204 NL 202/205/213/222/232/240/ 250/252/262/312 NM 152 NMT 222	

Auger Nr.	OEM Nr.	Description	Model	Picture
51444	81.43220.6203	Rep. Kit for Axle Rod ø85xø21/130	LION'S STAR LION'S COACH	
51445	81.43230.6051 81.43230.6068	Rep. Kit for Axle Rod ø75xø17/115	18.260/310/313... 24.350/400 - F 2000 F 90 L 2000 - M 2000 M 90 ÖAF	
51446	81.43270.6110	Rep. Kit for Axle Rod ø100xø25/152	ÖAF TGA F 2000	
53007	81.43220.6204	Rep. Kit for Axle Rod M24x2/ø95x74	18.220/260/280/310/313/350/370/400/420/460 22/24.330-420 - 24.350/400/460 - 28.270 322/352/402/422/462 FRH LION'S CLASSIC - LION'S COACH LION'S STAR RH 353/403/463 SG 28.260/310 STARLINER SUE 223/253/263/313 UEL 313/353	
53009	81.43230.6043 S	Rep. Kit for Axle Rod ø80xø19/130	12.170/192 14.170/192/220 15.220/240 16.220/240/280/281/290/291/321/33 1/360/361/370/372 17.220/240 19.281/291/321/331/361 22/24.330-420 22/24/25/26.220/240/281/291/321/33 1/361 F 90 M 90	
53056	81.43315.0009	Rep. Kit for Axle Rod ø95xø19/145	18.260/310/350/360/370/400/410/ 420/460 322/352/402/422/462 FRH LION'S COACH LION'S REGIO LION'S STAR RH 353/403/463 STARLINER TOURLINER TRENDLINER UEL 313/353	

Auger Nr.	OEM Nr.	Description	Model	Picture
51141	81.43270.6097 S	Rep. Kit for Axle Rod ø85xø25/152	TGA TGS TGX ECT 26 T	
53211	81.43270.6079	Rep. Kit for Axle Rod ø95xø23/152	18.310/313/350/360/370/400/410/ 420/460 22/24.330-420 24.310/350/400/460 F 2000 F 90 ÖAF	
53287	81.43220.6250	Rep. Kit for Axle Rod ø85xø19/130	18.220/280 F 2000 LION'S CITY LION'S CLASSIC ÖAF SL 18.220/260/280 TGA	
53289	81.96401.0152	Rep. Kit for Axle Rod ø95xø19x130	F 2000 F 90 ÖAF TGA	
53944	81.43220.6244	Rep. Kit for Axle Rod ø75xø17/115	TGA TGS TGX ECT 26 T	
54063	81.43220.6108 S	Rep. Kit for Axle Rod ø72xø19/130	16/17.170/192 22/24.330-420 F 90 M 90 ÖAF	
54188	85.43220.6002	Rep. Kit for Axle Rod ø75xø19/130	14.280 ECT18T/26T F 2000 L 2000 LION'S COACH LION'S REGIO LION'S STAR ND 313/363 RH 403/463 STARLINER TGA TOURLINER TRENDLINER UEL 313/353	

Auger Nr.	OEM Nr.	Description	Model	Picture
54189	81.43220.6241	Rep. Kit For Axle Rod ø95xø21/130	TGX TGS TGA F 2000 SONDERFAHRZEUGE	
54190	81.43270.6127	Rep. Kit For Axle Rod ø85xø19/130	LION'S CLASSIC SL 18.220/260/280 SUE 223/253/263/313 STARLINER CITYLINER TOURLINER TRENDLINER LION'S STAR LION'S COACH LION'S REGIO	
54572	81.43220.6197 81.95302.0038	Rep. Kit for Axle Rod ø67xø15/100	M 2000	
54637	81.43230.6060	Rep. Kit for Axle Rod ø85xM36x1.5/248	12.220 - 12/14.220 - 18.220 24.310/350 EL 202/222/262 ND 202 - NG 232 - NG 235 - NG 242/272 NG 252/262/272/312 NG 312 - NGT 204 NL 202/213/222/250/262/312 NL 202/222/252/262/312 NL 205 - L232 - NL232 - NL240 - NL262 NM 152 - NMT 222	
55118	81.43220.6285	Rep. Kit for Axle Rod ø85xø25/130	TGX TGS TGA ECT 18/26T	
55119	81.43270.6119	Rep. Kit for Axle Rod ø75xø19/115	TGM 14.280	
55053	81.43270.6097 S1	Rep. Kit for Axle Rod ø75xø23/130	TGA TGS TGX ECT 26 T	

Auger Nr.	OEM Nr.	Description	Model	Picture
55120	81.43270.6133	Rep. Kit for Axle Rod ø85xø21/130	UEL 313/353 MAN 322/352/402/422/462 LION'S COACH RH 403/463 18.310/350/370/400/420/460 STARLINER - CITYLINER TOURLINER - TRENDLINER LION'S STAR - LION'S COACH LION'S REGIO	
55121	81.43270.6126 81.43270.6118	Rep. Kit for Axle Rod ø85xø23/130	TGA TGX F 2000 SONDERFAHRZEUGE	
55122	81.43270.6072	Rep. Kit for Axle Rod ø90xø23/152	16.240/290/370 F2000 F 90 TGA M 2000 SONDERFAHRZEUGE ÖAF	
51447	81.43220.6108 81.43220.6132 81.43220.6109 81.43220.6290	Rep. Kit for Axle Rod ø72xø19/130	16.170/192 17.170/192 22/24.330-420 F 90 M 90 ÖAF	
51448	81.43230.6043	Rep. Kit for Axle Rod ø80xø19/130	12.170/192 - 14.170/192 - 14.240 15.220/240 16.220/240/280/281/290/291/321/ 331/360/361/370/372 17.220/240 19.281/291/321/331/361 22/24.330-420 22/24/25/26.220/240/281/291/321/ 331/361 F 90 - M 90	
51449	81.95301.6133	Rep. Kit for Axle Rod ø90xø23/152	12.170/192 14.170/192 16.170/192 17.170/192 22/24.330-420	
55054	81.43220.6322	Rep. Kit for Axle Rod ø72xø23/130	TGA TGX TGS	

Auger Nr.	OEM Nr.	Description	Model	Picture
51450	81.95301.6132 81.43270.6080	Rep. Kit for Axle Rod M24x1.5/ø90x59	12.170/192 - 14.170/192 16.170/192/240/280/290/360/370/ 372 - 17.170/192 18.310/313/350/360/370/400/410/ 420/460 22/24.330-420 24.310/350/400/460 F 2000 - F 90 ÖAF	
53010	81.43250.6009	Rep. Kit for Axle Rod ø20xø46x60	8/9.136/170 G 90 L 2000 TGL	
53057	81.43270.6047	Rep. Kit for Axle Rod M24x1.5/ø90x60	-	
53201	81.43270.6065	Rep. Kit for Axle Rod M20x1.5/ø72x46	14.280 F 90 L 2000 M 2000 M 90 ÖAF	
52791	81.96210.0447	Axle Rod Mounting ø94xø19/130	18.220/230/250/280/310/313 /350/370/400/420/460 22/24.330 24.310/350/400/460 - 28.270 322/352/402/422/462 FRH LION'S - RH 353/403 SG 28.260/310 - L 18.220/260/280	
53013	81.96210.0448	Axle Rod Mounting M24x2/ø94x75	18.220/230/250/280/310/313/350/ 370/400/420/460 322/352/402/422/462 FRH LION'S CLASSIC LION'S COACH LION'S STAR M 2000 SG/SL/UJEL	

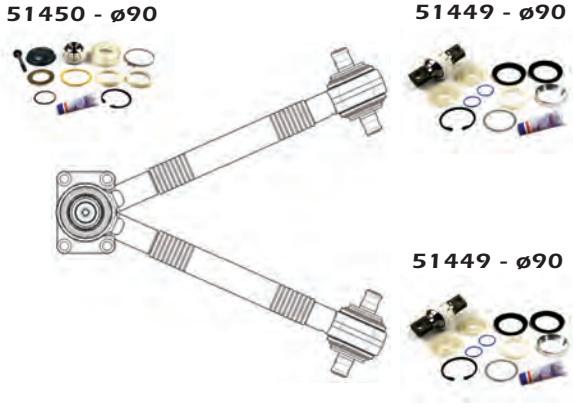
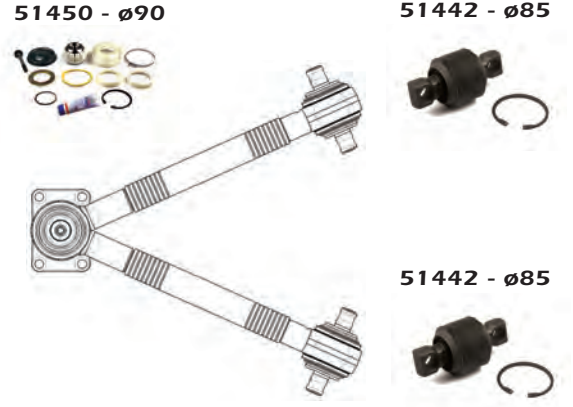
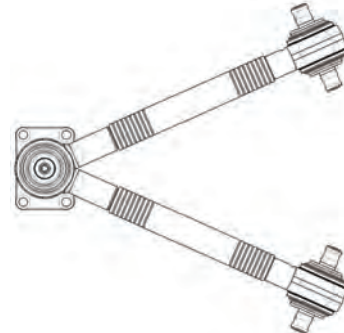

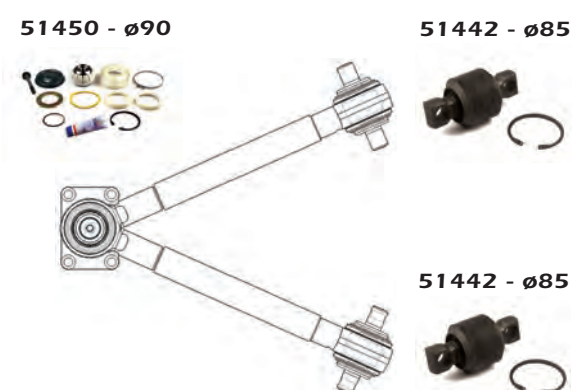
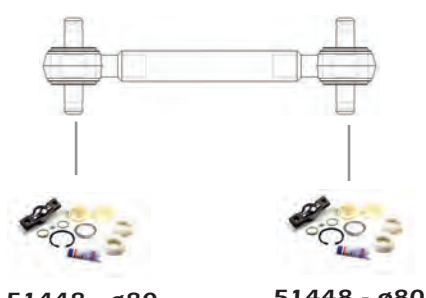
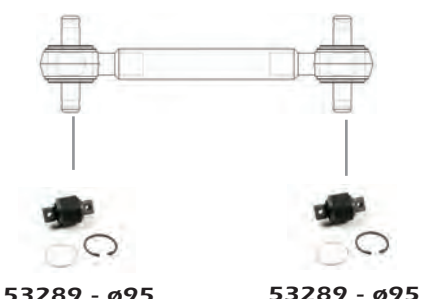
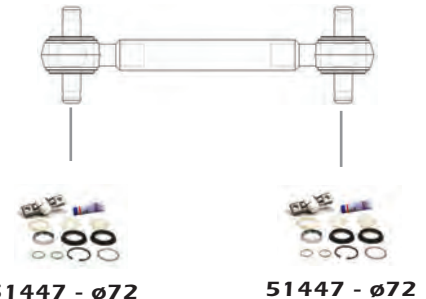

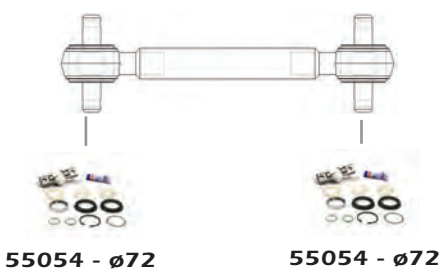
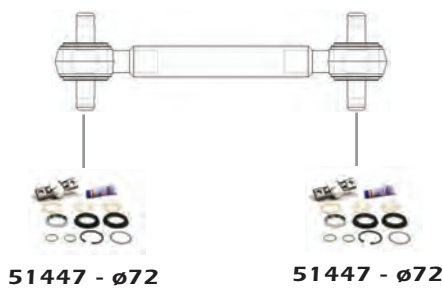
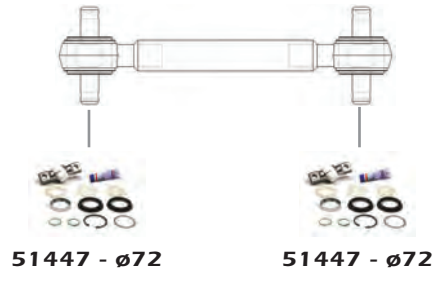
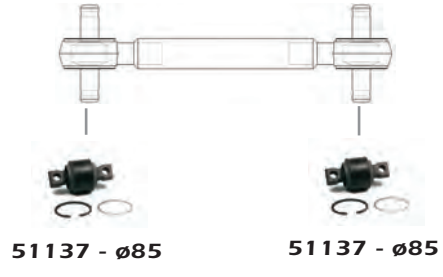
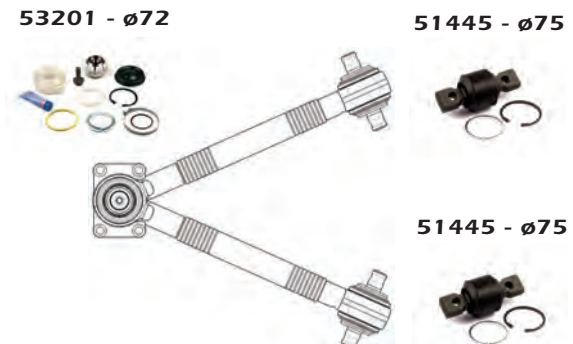
Auger Nr.	OEM Nr.	Description	Model	Picture
15073	81.43270.6030	V-Arm	14.220	
	81.43270.6034		15.220/240	
	81.43270.6054	L: 621	16/17.220/240/281/291/ 321/331/361	
	81.43270.6057		19.281/291/321/331/361	
	81.43270.6074		22/24/25/26.220/240/281/2	
	81.43270.6076		91/321/331/361	
	81.43270.6078		F 2000	
	81.43270.6078		F 90	
	81.43270.6082			
15140	81.43270.6096	V-Arm	ECT 26T	
	81.43270.6121		TGA	
	81.43220.6221	L: 627		
15163	81.43270.6030 S	V-Arm	14.220	
	81.43270.6034 S		15.220/240	
	81.43270.6054 S	L: 621	16/17.220/240/281/291/ 321/331/361	
	81.43270.6057 S		19.281/291/321/331/361	
	81.43270.6074 S		22/24/25/26.220/240/281/ 291/321/331/361	
	81.43270.6076 S		F 2000	
	81.43270.6078 S		F 90	
	81.43270.6078 S			
	81.43270.6082 S			

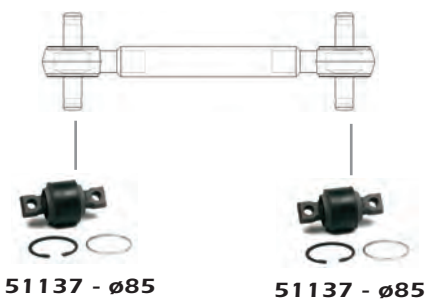
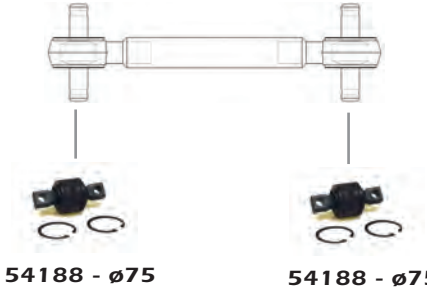
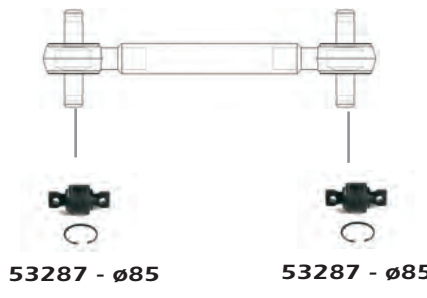
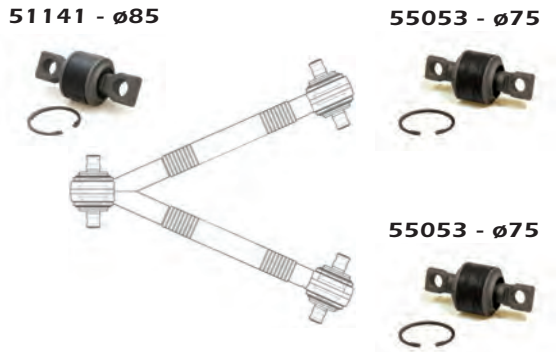
Auger Nr.	OEM Nr.	Description	Model	Picture
15169	81.43270.6117	V-Arm	TGX	
		L: 627	TGA F 2000	
15018	81.43230.6037	Torque Rod	14/15.220/15.240	
	81.43230.9037	L: 500	16.240/280/290/360/372 16.240/290/370 16.360/372 16/17.220/240 16/19.281/291/321/331/361 22/24/25/26.220/240 22/24/25/26.281/291/321/ 331/361 22/24/25/26.291/331/361	
15021	81.43220.6093	Torque Rod	F90	
	81.43220.6070	L: 585	F2000	
	81.43220.6119			
	81.43220.6091			
	81.43220.6071			
	81.43220.6072			
15023	81.43220.6236	Torque Rod	TGA	
	81.43220.9236	L: 566	TGS	
	81.43220.6267		TGX	
	81.43220.6272		ECT 18/26 T	

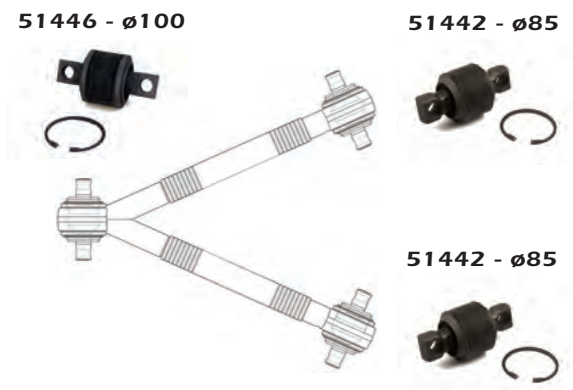
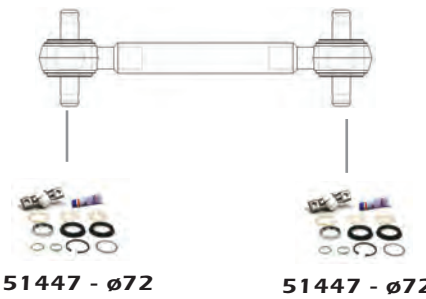
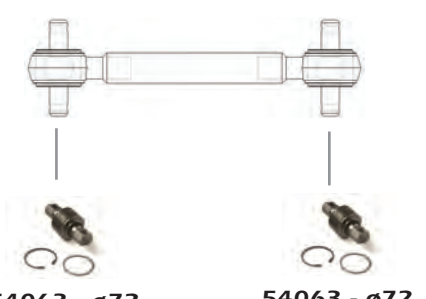
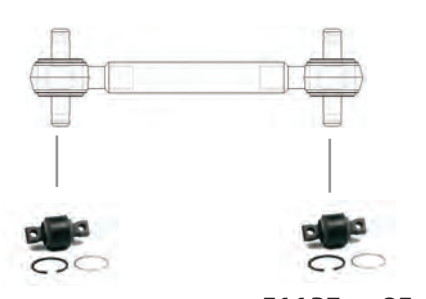



Auger Nr.	OEM Nr.	Description	Model	Picture
15024	81.43220.6247	Torque Rod L: 414	TGA TGS TGX	
15045	81.43220.6140 81.43220.9140	Torque Rod L: 596	L 2000 M 2000 M 90	
15046	81.43220.6174	Torque Rod L: 644	L 2000 M 2000	
15155	81.43220.6189 81.43220.6144 81.43220.6159 81.43220.6210 81.43220.6211	Torque Rod L: 614	N 4516 NG 262/263 NL202/222/223/262/263/313 SD 202 NU 223/263/313/353 CENTROLINER LION'S CITY	
15074	81.43270.6053 81.43270.9053	V-Arm L: 693	L 2000 M 90 M 2000	





Auger Nr.	OEM Nr.	Description	Model	Picture
15086	81.43220.6010	Torque Rod L: 565	26.240/281/291/301/321/331/ 361/365	 <p>51137 - \varnothing85 51137 - \varnothing85</p>
	81.43220.6012		27.281/291/321/331/361	
	81.43220.6013		30.281/291/321/331/361	
	81.43220.6020		32.240/281/291/301/321/331/ 361/365	
	81.43220.6035		33.281/291/321/331/361	
	81.43220.6040		34.281/291/321/331/361	
	81.43220.6041			
	81.43220.6052			
	81.43220.6056			
	81.43230.6018			
81.43230.6028				
15090	81.43220.6229	Torque Rod L: 572	TGA	 <p>54188 - \varnothing75 54188 - \varnothing75</p>
	81.43220.6304		TGS	
	81.43220.6305		TGX ECT 18/26 T	
15092	81.43220.6196	Torque Rod L: 596	F 2000	 <p>53287 - \varnothing85 53287 - \varnothing85</p>
	81.43220.6232		TGA	
	81.43220.6233		ÖAF	
15128	81.43270.6097	V-Arm L: 627	TGA	 <p>51141 - \varnothing85 55053 - \varnothing75</p> <p>55053 - \varnothing75</p>
	81.43270.6113		TGS	
	81.43270.6135		TGX ECT 26 T	





Auger Nr.	OEM Nr.	Description	Model	Picture
15130	81.43270.6137	V-Arm	TGA	
	81.43270.6116	L: 627	TGS TGX F 2000	
15148	81.43230.6030	Torque Rod	22/24.330-420	
	81.43230.6014	L: 571	F 90	
	81.43220.6096		M 90	
	81.43220.6097			
	81.43220.6098			
	81.43220.6129			
	81.43220.9129			
15150	81.43230.6030 S	Torque Rod	22/24.330-420	
	81.43230.6014 S	L: 571	F 90	
	81.43220.6096 S		M 90	
	81.43220.6097 S			
	81.43220.6098 S			
	81.43220.6129 S			
	81.43220.9129 S			
15149	81.43220.6092	Torque Rod	26T	
	81.43220.6090	L: 590	F 2000	
	81.43220.6067		F 90	
	81.43220.6068		ÖAF	
	81.43220.9092		TGA	

Auger Nr.	OEM Nr.	Description	Model	Picture			
10027	81.46710.6395	Tie Rod	L 2000 8.103	 <p style="text-align: center;">10007 10007</p>			
	81.46710.6851	L: 1630	L 2000 8.224				
	81.46710.6852		L 2000 9.123				
	81.46711.6719		L 2000 9.224				
			L 2000 10.150				
		L 2000 10.224					
		M 2000 L 12.163					
		M 2000 L 12.224					
		12.153					
10073	81.46710.6396	Tie rod	G-M-F90	 <p style="text-align: center;">10001 10001</p>			
	81.46710.6131	L: 1628	L-M-F2000				
	81.46710.6397		16				
	81.46710.6816		17				
	81.46710.6904		18				
	81.46711.6724		19				
	81.46710.6359		24				
	81.46710.6360		26				
	81.46710.6362		28				
	81.46710.6265		30				
	81.46710.6266		31				
			32				
			33				
			34				
	35						
10162	81.46710.6122	Tie rod	F 2000-19.233	 <p style="text-align: center;">10001 10001</p>			
	81.46710.6167	L: 1575	F 2000-33.603				
	81.46710.6194		F 90-19.262				
	81.46710.6195		F 90-40.422				
	81.46710.6378		LION'S COACH				
	81.46710.6379		M 2000-L 18.224				
	81.46710.6380		M 2000-L 18.285				
	81.46710.6830		M 2000-M 18.224				
	81.46710.6836		M 2000-M 25.284				
	81.46710.6429		M 90-17.192				
	81.46710.6912		M 90-17.232				
	81.46711.6736		TGA-26.310				
	81.46710.6432		TGA-33.530				
	81.46710.6832						
	81.46710.6916						
	10155		81.46710.6453		Tie rod	LION'S STAR	
			81.46710.6457		L: 699	SÜ 242	
81.46710.6458		ÜL 313					
81.46710.6881		ÜL 353					

Auger Nr.	OEM Nr.	Description	Model	Picture	
10158	81.46710.6238	Tie rod	6.100 F	 <p>10007 10007</p>	
	81.46710.6240	L: 1430	8.100 F		
	81.46710.6242		9.150 F		
	81.46710.6409		10.150 F		
10159	81.46710.6436	Tie rod	12.152	 <p>10003 10003</p>	
	81.46710.6437	L: 1430	14.192		
			12.192		14.222
			12.222		14.232
			12.232		14.262
			12.262		14.272
			12.272		
		14.152			
10161	81.46710.6198	Tie rod	TGA	 <p>10001 10001</p>	
	81.46710.6353	L: 1652	18 Ton		
	81.46710.6354		26 Ton		
	81.46710.6361		33 Ton		
	81.46711.6725		35 Ton		
	81.46710.6112		41 Ton		
	81.46710.6163				
	81.46710.6165				
10076	81.46711.6877	Tie rod	LION'S STAR		
	81.46711.6771	L: 413	LION'S COACH		
	81.46711.6878		ÜL 313		
	81.46711.6879		ÜL 353		
	81.46711.6871				
10164	81.46710.6434	Tie rod	12.152	 <p>10030 10030</p>	
	81.46710.6435	L: 863	12.192		
			12.222		
			12.232		
			12.262		
			12.272		
			14.152		
			14.192		
			14.222		
			14.232		
			14.262		
			14.272		

Auger Nr.	OEM Nr.	Description	Model	Picture
10167	81.46711.6759	Tie rod L: 729	SG 242	
	81.46710.6877		SG 292	
	81.46710.6879		SL 322	
	81.46711.6760		SR 290	
	81.46711.6761		SR 280	
	81.46710.6081		SR 292	
	81.46710.6137			
	81.46710.6173			
	81.46710.6294			
	81.46710.6444			
	81.46710.6875			
81.46710.6419				
10168	81.46710.6418	Tie rod L: 1775	32.262 35.262 41.262	
			32.272 35.272 41.272	
			32.292 35.292 41.292	
			32.302 35.302 41.302	
			32.322 35.322 41.322	
			32.332 35.332 41.332	
			32.342 35.342 41.342	
			32.362 35.362 41.362	
			32.372 35.372 41.372	
			32.402 35.402 41.402	
			32.422 35.422 41.422	
10169	81.46710.6926 81.46710.6935 81.46711.6810 81.46711.6744	Tie rod L: 1440	L 2000 8.153	
			L 2000 8.224	
			L 2000 10.153	
			L 2000 10.225	
			M 2000 L 14.224	
			M 2000 L 14.284	
M 2000 M 14.224				
M 2000 M 14.284				
10170	81.46710.6442 81.46710.6443	Tie rod L: 1000	17.192 24.222	
			17.222 24.232	
			17.232 24.262	
			17.272 24.272	
			18.192	
			18.222	
			18.232	
			18.272	
			24.192	
10171	81467116778 81.46711.6727 81.46711.6732 81.46711.6844	Tie rod L: 1720	M 2000-M 25.224	
			M 2000-M 25.264	
			M TG-A	

Auger Nr.	OEM Nr.	Description	Model	Picture		
10172	81.46710.6865	Tie rod L: 1635	10.145	9.153		
	81.46710.6866		8.103	9.163		
	81.46711.6717		8.113	9.185		
			8.145	9.223		
			8.153	9.224		
			8.163	9.225		
			8.185			
			8.223			
			8.224			
			8.225			
	9.145					
10174	81.46710.6388	Tie rod L: 1520	17.192			
	81.46710.6393		17.222			
	81.46710.6390		17.232			
			17.272			
			18.192			
			18.222			
			18.232			
			18.272			
			24.192			
			24.222			
	24.232					
	24.262					
	24.272					
10175	81.46710.6438	Tie rod L: 995	17.192			
	81.46710.6439		17.222			
			17.232			
			17.272			
			18.192			
			18.222			
			18.232			
			18.272			
			24.192			
			24.222			
	24.232					
	24.262					
	24.272					
10176	81.46710.6933	Tie rod L: 1630	L 14.163			
	81.46711.6711		L 14.265			
	81.46710.6934		L15.163			
			L 15.265			
			L15.285			
			M 14.224			
	M 14.285					
10178	81.46611.6064	Tie rod L: 710	24.242	25.302	33.272	
	81.46610.6159		24.262	25.322	33.322	
	81.46610.6169		24.272	25.332		
	81.46610.6200		24.292	25.362		
	81.46610.6200		24.302	25.372		
	81.46610.6275		24.322	25.422		
	81.46610.6317		24.332	26.272		
	81.46610.6317		24.362	26.302		
	81.46710.6280		24.372	26.322		
	81.46710.6319		24.422	26.372		
	24.462	26.402				
	25.272	26.422				





Auger Nr.	OEM Nr.	Description	Model	Picture
10179	81.46710.6253	Tie rod L: 1575	26.603	
	81.46710.6254		27.373	
	81.46710.6255		27.603	
	81.46710.6375		33.373	
	81.46710.6376		33.603	
	81.46710.6928		35.302	
	81.46711.6735		35.322	
	81.46710.6377			
10180	81.46710.6994	Tie rod L: 1664	19.273 23.403 26.323	
	81.46711.6726		19.293 23.463 26.343	
			19.314 24.273 26.373	
			19.323 24.293 26.403	
			19.343 24.323 26.423	
			19.364 24.343 26.463	
			19.373 24.373	
			19.403 24.403	
			19.414 24.423	
			19.423 24.463	
			19.463 26.233	
			23.293 26.273	
			23.343 26.293	
10183	81.46710.6080	Tie rod L: 501	LION'S COACH	
	81.46710.6136		LION'S STAR	
	81.46710.6172		SG 220	
	81.46710.6295		SG 312	
	81.46710.6337		SL 200	
	81.46710.6345		SÜ 240	
	81.46710.6421		SÜ 322	
	81.46710.6451		ÜL 313	
	81.46710.6876		ÜL 353	
10185	81.46710.6314	Tie rod L: 1545	12.152	
	81.46710.6315		12.192	
	81.46710.6316		12.222	
			12.232	
			12.262	
			12.272	
			14.152	
			14.192	
	14.222			
	14.232			
	14.262			
	14.272			
10186	81.46710.6862	Tie rod L: 1689	EL 222	
	81.46710.6863		EL 262	
	81.46710.6864		NG 262	
	81.46710.6909		NG 312	
	81.46710.6910		NL 202	
	81.46710.6974		NL 263	
	81.46711.6712		NL 312	

Auger Nr.	OEM Nr.	Description	Model	Picture
10189	81.46711.6773 81.46711.6858	Tie rod	M 2000-L 18.224 M 2000-M 18.224 TGA18.310 TGA 41.360	 <div style="display: flex; justify-content: space-around;"> 10368 10368 </div>
10190	81.46611.6161 82.46610.6186	Tie rod steering L: 1800	-	
10363	81.46710.6251 81.46710.6175 81.46710.6420	Tie rod steering L: 785	SG 220 SG 240	
10505	81.46610.6684 81.46610.6375	Tie rod L: 1066	NL 202 NG 252 NG 312 EL 202 NL 232 NG 235 NG 240	 <div style="display: flex; justify-content: space-around;"> 10502 10502 </div>
10506	81.46610.6694	Tie rod L: 1650	10.150 11.150 10.180 11.180 10.190 11.190 10.220 11.220 10.230 11.230	 <div style="display: flex; justify-content: space-around;"> 10001 10001 </div>











Auger Nr.	OEM Nr.	Description	Model	Picture
10507	81.46610.6313	Tie rod	16.200	
	81.46610.6063	L: 890	16.240 16.280 16.290	
10549	81.46610.6654	Tie rod steering	10.150 11.150	
	81.46611.6061	L: 1375	10.180 11.180 10.190 11.190 10.220 11.220 10.230 11.230	
10550	81.46710.6880	Tie rod steering	SG 220	
	81.46710.6398	L: 729		
	81.46710.6878			
10551	81.46610.6708	Tie rod steering	SL 232	
	81.46611.6067	L: 900		
	81.46610.6059			
10552	81.46610.6035	Tie rod steering	-	
	81.46610.6111	L: 760		
	81.46610.6139			





Auger Nr.	OEM Nr.	Description	Model	Picture
10640	81.46611.6081	Tie rod steering L: 1000	24.310/350 NL 202 NL 262 18.220	  10031  10031
10641	85.46610.6107 85.46610.6143	Tie rod steering L: 807	M 2000	  10001  10001
10642	81.46611.6017	Tie rod steering L: 1245	24.310/350 NL 202 NL 262 18.220	
10026	81.46610.6578 81.46610.6798 81.46610.6598 81.46610.6876	Drag link L: 725	32.293-32.463 35.343-35.463 41.343-41.463 32.262-32.422-	  10001  10001
10028	81.46610.6753 81.46610.6744 85.46610.6104 85.46610.6616 85.46610.6539	Drag link L: 825	10.145 9.163 8.103 9.185 8.113 9.223 8.145 9.224 8.153 9.225 8.163 8.185 8.223 8.224 8.225 9.45 9.153	  10007  10007

Auger Nr.	OEM Nr.	Description	Model	Picture				
10047	85.46610.6151	Drag link L: 965	M 14.224					
	85.46610.6020		M 14.264					
	85.46610.6692		M 14.284					
	85.46610.6693							
	85.46610.6695							
	85.46610.6120							
10154	81.46610.6725	Drag link L: 826	10.145 9.163					
	85.46610.6102		8.103 9.185					
			8.113 9.223					
			8.145 9.224					
			8.153 9.225					
			8.163					
			8.185					
			8.223					
			8.224					
			8.225					
			9.45					
			9.153					
			10156		81.46610.6088	Drag link L: 800	19.233 33.323	
81.46610.6288	19.603 33.603							
	23.293 35.343							
	23.463 35.463							
	24.273 41.343							
	24.463 41.463							
	26.233							
	26.603							
	27.273							
	27.603							
	32.293							
	32.463							
	10157	81.46610.6301		Drag link L: 785	6.100 F			
		81.46610.6305			8.100 F			
81.46610.6328		9.150 F						
		10.150 F						
10160	81.46611.6006	Drag link L: 1070	19.273 - 19.463					
	81.46610.6656		27.273 - 27.403					
	81.46610.6659		33.323 - 33.603					
			19.262 - 19.422					
			26.242 - 26.422					
	33.342 - 33.422							

Auger Nr.	OEM Nr.	Description	Model	Picture				
10163	81.46610.6360	Drag link L: 1040	F90-F2000 17 Ton					
	81.46610.6361		16.281+361 19 Ton					
	81.46610.6721		19.281+361 24 Ton					
	81.46610.6722		22.281+361 26 Ton					
	81.46610.6723		24.281+361 28 Ton					
	81.46610.6723		26.281+361 30 Ton					
	81.46610.6354		32.281+361 31 Ton					
	81.46610.6355		33.281+361 32 Ton					
	81.46610.6333		34.281+361 33 Ton					
	81.46610.6334		16 Ton 34 Ton 35 Ton					
10165	81.46610.6790	Drag link L: 1750	32.293					
	81.46610.6791		32.343					
			32.403					
			32.463					
			35.343					
			35.403					
			35.463					
			41.343					
			41.403					
			41.463					
10166	81.46610.6779	Drag link L: 1022	19.233 24.273 26.343					
			19.273 24.293 26.373					
			19.293 24.323 26.403					
			19.314 24.343 26.423					
			19.323 24.373 26.463					
			19.343 24.403 26.603					
			19.364 24.423 27.273					
			19.373 24.463 27.293					
			19.403 26.233 27.323					
			19.414 26.273 27.343					
			19.423 26.293 27.373					
			19.463 26.323 27.403					
			10173		85.46610.6021 85.46610.6121 85.46610.6140	Drag link L: 840	L 2000 12.185 85	
							L 2000 12.225	
L 2000 12.153 :19,9								
M 2000 L 12.163 M 2000 L 12.224								

Auger Nr.	OEM Nr.	Description	Model	Picture
10177	85.46610.6119	Drag link L: 902	M 14.224	
	85.46610.6019		M 14.264	
	85.46610.6150		M 14.284	
10181	81.46610.6584	Drag link L: 870	M 2000-M 25.224	
			M 2000-M 25.264	
10182	81.46611.6087	Drag link L: 990	TGA 18.310	
	81.46611.6097		TGA 33.530	
	81.46611.6133		18 Ton	
	81.46611.6132		26 Ton	
	81.46611.6096		33 Ton	
	81.46611.6088		35 Ton	
	81.46611.6197		41 Ton	
	81.46611.6198			
10184	81.46610.6068	Drag link L: 1824	SL 200	
	81.46610.6209		SG 220	
	81.46610.6232		SG 240	
	81.46610.6233		SR 240	
	81.46610.6261		SR 280	
	81.46610.6507			
	81.46610.6529			







Auger Nr.	OEM Nr.	Description	Model	Picture
10187	81.46610.6374 81.46611.6019	Drag link L: 1050	EL 222 EL 262 NG 262 NG 312 NL 202 NL 263 NL 312	  10001  10001
10188	81.46610.6603	Drag link	24.242 25.302 33.272 24.262 25.322 33.322 24.272 25.332 24.292 25-362 24.302 25.372 24.322 25.422 24.332 26.272 24.362 26.302 24.372 26.322 24.422 26.372 24.462 26.402 25.272 26.422	  10553  10553
10665	83.46610.6001 83.46610.6501 81.46611.6217	Drag link L: 1050	18.230/250 SL 18.220/260/280	  10001  10001
10676	81.46611.6004	Drag link L: 1010	F 2000 ÖAF	

Auger Nr.	OEM Nr.	Description	Model	Picture
10001	81.95301.0016	Tie rod	F 2000	
	81.95301.6048		F 90	
	81.95301.6049	L: 125	M 2000	
	81.95301.6053	M30x1,5 RHT	M 90	
	81.95301.6278		SG,SL	
	81.95301.6108		TGA	
	81.95301.6112			
	81.95301.6143			
	81.95301.6224	81.95301.6194		
	81.95301.6234	81.95301.6178		
	81.95301.6242	81.95301.6156		
	81.95301.6274	81.95301.6154		
	81.95301.0084	81.95301.6149		
	81.95301.6308	81.95301.6126		
	81.95301.6352			
81.95301.6312				
81.95301.6090				
10002	81.95301.0015	Tie rod end	NG-LK-MK-SK	
	81.95301.6030		ATEGO-AXOR	
	81.95301.6237	L: 125	ACTROS Series	
	81.95301.6050	M30x1.5 LHT		
	81.95301.6087			
	81.95301.6107			
	81.95301.6120			
	81.95301.6152			
	81.95301.6043			
	81.95301.6223			
	81.95301.6054			
	81.95301.6275			
	81.95301.6168			
	81.95301.6179			
	81.95301.6279			
10003	81.95301.0014	Tie rod end	NG-LK-MK-SK	
	81.95301.0064		Series	
	81.95301.6162	L: 115		
	81.95301.6239	M30x1.5 RHT		
	81.95301.0067			
10004	81.95301.6163	Tie rod end	NG-LK-MK-SK	
	81.95301.0082		Series	
	81.95301.6068	L: 115		
	81.95301.0074	M30x1.5 LHT		
	81.95301.0013			
	81.95301.6273			
10007	81.95301.6060	Tie rod end	45 FA	
	81.95301.6135		F 1200	
	81.95301.6140	L: 105	F 1700	
	81.95301.6249	M28x1.5	F 1900	







Auger Nr.	OEM Nr.	Description	Model	Picture
10008	81.95301.0079	Tie rod end	45 FA	
	81.95301.6139	L: 105	F 1200	
	81.95301.6222	M28x1.5	F 1700 F 1900	
10009	81.95301.6250	Tie rod end	85 CF	
	81.95301.6270	L: 141	XF 95	
10018	81.95301.6286	Tie rod end L: 143	85 CF 95 FA 95 FAD 95 FAK 95 FAT 95 FT 95 FTG 95 FTT 95 XF	
10030	81.95301.0025	Tie rod end L: 125 M30x1.5	NG-LK Series 709-917/1013-1024 CH380.xxx CH673.xxx etc.	
10033	81.95301.0077	Tie rod end	LK Series	
	81.95301.6134	L: 95	709-809-811 etc.	
	81.95301.6142	M24x1.5	CH314.xxx	
	81.95301.6303		CH316.xxx etc.	
10034	81.95301.6288	Tie rod end	TGA	

Auger Nr.	OEM Nr.	Description	Model	Picture
10035	81.95301.6304	Tie rod end	L 2000	
	81.95301.0078	L: 128		
	81.95301.6141			
	81.95301.6235			
10037	81.95301.6248	Tie rod end	M 90 M 2000	
		L: 86		
10038	81.95301.6219	Tie rod end	F 90 F 2000	
	81.95301.6226	L: 81		
	81.95301.6267			
	81.95301.6291			
	81.95301.6225			
10039	81.95301.6127	Tie rod end	G90	
		L: 86		
10040	81.95301.0041	Tie rod end	ALL TYPES	
		L: 73		
10041	81.46711.6778 P	Tie rod	L 2000 8.103	
		L: 145	L 2000 8.224	
			L 2000 9.123	
			L 2000 9.224	
			L 2000 10.150	
			L 2000 10.224	
			M 2000 L 12.163	
			M 2000 L 12.224	
			12.153	

Auger Nr.	OEM Nr.	Description	Model	Picture
10042	81.95301.6263	Tie rod end L: 158	F 2000 F 90 26.270	
10045	81.95301.6123 81.46610.6184P	Tie rod end L: 95	SG 220	
10046	81.95301.6117	Tie rod end L: 95	SG 220	
10502	81.95301.6233 81.95301.6255	Tie rod end L: 125	NL 202 NG 312 NL 232 NG 240 NG 252 EL 202 NG 235	
10553	81.46610.6603 P	Tie rod end L: 125	F 90	
10036	81.95301.0038 81.95301.6016 81.95301.6169 81.95301.6172 81.95301.6176 81.95301.6015	Ball joint L: 86	F 4 F 6 FL 4 FL 6	

Auger Nr.	OEM Nr.	Description	Model	Picture
10112	81.95302.0044	Ball Joint	L 2000	
	81.95302.0043		M 2000	
	81.95302.0051			
	81.95302.0053			
10498	81.95301.6173	Ball Joint	F 2000	
	81.95301.6170		F 90	
	81.95301.6064		G 90	
	81.95301.6130		L: 55 M12x1.75 RHT L 2000 M 2000 M 90 TGM TGL	
10499	51.90001.0166	Ball Joint	18.220/230/250	
	81.95301.6174		18.220/290/370	
	81.95301.6171		L: 55 M12x1.75 LHT LION'S CLASSIC	
	81.95301.6063		SL 18.220/260/280	
81.95301.6131	TGM			
10567	81.95301.0045	Ball Joint	8.125 STAR	
			12.155 STAR	
			18.220/230/250	
			18.230/250	
L: 86	L 2000			
M14x1.5	M 2000			
	L 2000			
	MAN 292/332/362			
10579	81.95301.6144	Ball Joint	TGA	
	06.36090.0605		F 90	
	81.95301.7004		F 2000	
		M8x1.25 Rx47	M 90	
			ÖAF	
10580	81.95301.6204	Ball Joint	TGA	
			F 90	
			F 2000	
		M8x1.25 Lx47	M 90	
			ÖAF	
10582	81.95301.6200	Ball Joint	F 2000	
	81.95301.6202		F 90	
	81.95301.6227		L: 113 M 2000 M 90	

Auger Nr.	OEM Nr.	Description	Model	Picture
52792	81.96020.0403 81.96020.0391	Engine Mounting ø96x84	12.220 - 18.220/290/370 - 26T CENTROLINER F 2000 - F 90 - L 2000 LION'S CITY M 2000 NG 263/313 - NL 223/263/313 ÖAF	
52793	81.96020.0386	Engine Mounting ø88x72	322/352/402/422/462 FRH LION'S COACH RH 353/403/463	
52794	81.96020.0384	Engine Mounting ø107x85	322/352/402/422/462 FRH 12.220 CENTROLINER LION'S CITY LION'S COACH NG 263/313 NL 223/263/313 NM 223/283 RH 353/403/463	
53096	81.96020.0341 81.96020.0373 81.96020.0385 81.96020.0408 81.96020.0418	Engine Mounting ø107x85	18.220/260/290/310/313/350/360/ 370/400/410/420/460 22/24.330-420 24.310/350/400/460 - 26T 322/352/402/422/462 FRH D2840 - F 2000 - F 90 M 2000 LION'S COACH ÖAF RH 353/403/463 TGA	
53097	81.96020.0205 81.96020.0235	Engine Mounting ø96x84	10/11.150/180/190/220/230 12.170/192 - 14.170/192 16.170/192 - 17.170/192 8/9.136/170 CENTROLINER - GOEPEL AUFBAU - LION'S CITY D2866 - D2876 - G 90 - L 2000 M 90 NL 223/263/313 ÖAF	
53098	81.96020.0202 81.96020.0239 81.96210.0509	Engine Mounting ø80x55.5	10/11.150/180/190/220/230 12.170/192/220 13.210/220/230 14.170/192/220 16/17.170/192 - 266M-STAR 6/8.90 F/FR - 8/9.136/170 F 2000 - F 90 - G 90 - L 2000 M 2000 - M 90 ÖAF SG 292	

Auger Nr.	OEM Nr.	Description	Model	Picture
53099	81.96020.0382 88.96210.0004	Engine Mounting ø96x84	10/11.150/180/190/220/230 12.220 13.210/220/230 - 14.280 18.220/230/250/280 266M-STAR - D0836 - F 90 L 2000 - M 2000 - M 90 LION'S CITY - LION'S CLASSIC ÖAF SL 18.220/260/280 SUE 223/253/263/313	
53100	81.96020.0402	Engine Mounting ø126x105	F 2000 ÖAF	
53111	81.96020.0340	Engine Mounting ø88x72	18.220/260/290/310/313/350/360/ 370/400/410/420/460 22/24.330-420 24.310/350/400/460 F 2000 F 90 NM 223/283 ÖAF	
51534	51.90020.0356 51.90020.0284 51.90020.0357 51.90020.0381 51.90020.0275	Cylinder Head Bolt 14x2/140	D0824 D0826 G0826	
51536	51.90490.0023 51.90020.0269 51.90020.0235	Cylinder Head Bolt M15x2/143	D2530 D2565 D2566 D2840 D2842 D2865 D2866 D2876 E2866 E2876 G2866 G2876	
51537	51.90490.0024 51.90020.0270 51.90020.0236	Cylinder Head Bolt M15x2/110	D2530 D2565 D2566 D2840 D2842 D2865 D2866 D2876 E2866 E2876 G2866 G2876	

Auger Nr.	OEM Nr.	Description	Model	Picture	
51531	51.90020.0298	Flywheel Bolt	D2066	D2876	
	51.90020.0349	M16x1.5/72	D2565	E2866	
	51.90030.0025		D2566	E2876	
			D2676	G2866	
			D2840	G2876	
			D2842		
			D2865		
	D2866				
51387	51.02130.0013 S	Intermediate Ring, (Surface Hardened) ø115xø120x21	D2066	D2876	
	51.93020.0236 S		D2530	E2866	
			D2565	E2876	
			D2566	G2866	
			D2676	G2876	
			D2840	GS UEH	
			D2842	270/290/320/370	
			D2865		
			D2866		
52790	81.39410.6019	Propeller Shaft Bearing ø65	16.170/192/200/240/280/281/290		
	81.39410.6017		331/360/361/372		
	81.39410.6013		17.170/192		
	81.99804.3084		19.240/281/291/321/331/361		
			22.220/240/281/291/321/331/361		
			24.220/240/281/291/321/331/361		
			25.220/240/281/291/321/331/361		
			26.220/240/281/291/301/321/331		
			30.281/291/321/331/361		
			32.240/281/291/321/301/331/361		
			33.281/291/321/331/361		
	34.281/291/321/331/361				
	SG 280/292 - SL 200				
	SR 240/280 - SUE 240/280				
53267	81.39410.6018	Propeller Shaft Bearing ø100	L 2000		
	81.39410.6016		M 2000		
54204	81.39410.6023	Propeller Shaft Bearing ø85	12.220		
	81.39410.6031		18.220/290/370		
			26T		
			CENTROLINER		
			F 2000		
			F 90		
			L 2000		
			LION'S CITY		
			M 2000		
			NG 263/313		
			NL 223/263/313		
			ÖAF		
55427	81.39410.6032	Propeller Shaft Bearing ø75	TGA		
	81.39410.6020				



Auger Nr.	O.E.M. Nr.	A	B	C	Type	Repair Kit
54829	06.36959.0023 - 06.36959.0019	ø20	ø42	25	1	54635
55265	06.36950.0508 06.36959.0017 - 81.93430.0003	ø20	ø35	16	1	55135
54830	06.33719.0010	ø14	ø20	12	2	54635
55266	06.33719.0021 - 81.93401.0024	ø14	ø20	14	2	55135

Auger Nr.	OEM Nr.	Description	Model	Picture
-----------	---------	-------------	-------	---------

51508 81.96210.0089 Gearbox Mounting
M16/ø100x74

12.220
14.280
14/15.220
15.240
F 2000
F 90
ÖAF



54635 81.32670.6199 Rep. Kit for Gear Shift
81.32605.6085 Lever

322/352/402/422/462 FRH
18.220/230/250 - 18.220/290/370
LION'S CLASSIC - LION'S COACH
RH 353/403
SUE 223/253/263/313
ÖAF
F 2000 - F 90
L 2000 - M 2000 - M 90



54636 81.91020.0603 S Rep. Kit for Gear Shift
Lever

CITYLINER
F 2000 - F 90 - L 2000
LION'S CLASSIC - LION'S COACH
LION'S REGIO
M 2000 - M 90 - ÖAF
RH 353/403
SL 18.220/260/280
SUE 223/253/263/313
TGL - TGM
TOURLINER
TRENDLINER



54638 81.32655.6157 Rep. Kit for Shift
Mechanism

TGA
TGS
TGX
ECT 18 T









Auger Nr.	OEM Nr.	Description	Model	Picture
55134	81.32670.6259	Rep. Kit for Gear Shift Lever	18.220/230/250 F 2000 F 90 M 2000 ÖAF	
55135	81.32670.6200	Rep. Kit for Gear Shift Lever	16/19.281/291/321/331/361 22/24/25/26.281/291/321/331/361 26/32/33/34.281/291/321/331/361 26/27/32/33/34.281/291/321/331/361 16/17.220/240/19.240 30/32/33/34.281/291/321/331/361 22/24/25/26.220/240 14/15.220/15.240 16/17.220/240 26/32.365 SONDERFAHRZEUGE	
55281	81.97010.6010	Handle	18.220 18.290 18.370 F 90 F 2000 L 2000 M 90 M 2000	
55282	81.97010.6001	Handle	F 90 16.281/291/321/331/361/381 19.281/291/321/331/361/381 22.281/291/321/331/361/381 24.281/291/321/331/361/381 25.281/291/321/331/361/381 26.281/291/321/331/361/381	
51422	81.96020.0056 81.96020.7000 51.96210.0002	Rubber Mounting for Radiator M8/ø40x30	-	
51423	81.96210.0119	Rubber Mounting for Radiator M10/ø50x30	-	

Auger Nr.	OEM Nr.	Description	Model	Picture
51426	81.96210.0100	Rubber Mounting for Radiator M10/ø50x45	18.220/230/250/260/280/310/313/350/370/400/420/460 22/24.330-420 24.350/400/460 L 2000 LION'S CITY M 90 RH 352/402/422 SL 18.220/260/280 SUE 223/253/263/313	
51437	81.96210.0248 81.96210.0243	Rubber Mounting for Radiator ø13xø68.5x20	10/11.150/180/190/220/230 16.200/240/280/290/360/370/372 18.220/230/250/260/280/310/313 19.240 22/24.330-420 26/32.281/301/321 28.270 322/352/402/422/462 FRH EL 202/222/262 F 2000 F 90 TGA LION'S CITY LION'S CLASSIC ND202 NG 232/242/252/262/272/312 NL 202/205/213/222/232/250/252/262/310/312 NM152	
53273	81.96210.0426	Rubber Mounting for Radiator ø12xø38.5x44	10/11.150/180/190/220/230 12.220 13.210/220/230 14.220/280 18.220 18.310/313/350/370/400/420/460 22/24.330-420 24.310/350/400/460 26T 28.270 F 2000 F 90 LION'S CLASSIC LION'S COACH LION'S REGIO TRENDLINER M 2000 NM 223/283 ÖAF SG 28.260/310 SUE 223/253/263/313	





Auger Nr.	OEM Nr.	Description	Model	Picture
54937	-	Silicone Hose ø100x200	-	
54938	81.96420.0506	Silicone Hose ø120x130	F 2000 LION'S COACH LION'S STAR STARLINER TOURLINER	
54939	-	Silicone Hose ø90x130	-	
54940	-	Silicone Hose ø90x200	-	
54941	-	Silicone Hose ø90x150	-	
54942	81.96320.0159	Silicone Hose ø50x160	10/11.150/180/190/220/230 14.280 18.220/260/280/310 EL 202/222/262 LION'S CITY ND 202 NG 252/262/263/272/312/313 NL 202/222/223/252/262/263/310/313 NM 152 CENTROLINER	



Auger Nr.	OEM Nr.	Description	Model	Picture	
54943	81.96301.0648	Silicone Hose	26T 6X6		
		ø100x190	26/27T 6X4		
54944	81.96320.0175	Silicone Hose	12.155/ 220		
	81.96320.0115		13.210/220/230		
	81.96320.0148	ø65x180			14.220/280
					18.220/280/290..
			266M-STAR		
			28,270		
			8.125 STAR		
			CENTROLINER		
			EL 202/222/262		
			L 2000		
			LION'S CLASSIC		
			ND 202		
			NG 252/262/263/272/312/313		
			NL 202/213/222/...		
			NM 223/283		
54945	81.96301.0587	Silicone Hose	F90		
	81.96301.0543	ø100x240	LION'S COACH		
			LION'S STAR		
			MAN 322/352/402/422/462		
			NG SERIES		
			RH SERIES		
			STARLINER		
			TOURLINER		
54946	81.96301.0590	Silicone Hose	18.310/350/370/400/420/460		
		ø90x205	22/24.330-420		
			24.350/400		
			28.270		
			CENTROLINER		
			EL, ND, NL, NG SERIES		
			RH, SG, SUE SERIES		
			LION'S CITY		
			LION'S CLASSIC		
54947	81.96301.0668 S	Silicone Hose	26T 6X6		
		ø90x290	26/27T 6X4		
54948	81.96301.0668	Silicone Hose	26T 6X6		
	81.96301.0883		26/27T 6X4		
	81.96301.0900	ø90x290			
	81.96301.0901				
	81.96301.0902				
	81.96301.0903				



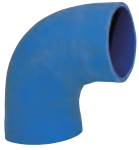

Auger Nr.	OEM Nr.	Description	Model	Picture
54949	81.96301.0900	Silicone Hose ø90x290	18.220/310/313/350/370/400/420 22.330 24.310/350/400 - 32.310 ECT 18T / 26T F 2000 - F90 ND, NG, NL SERIES SL, SUE SERIES STARLINER TGA - TGS - TGX TOURLINER - TRENDLINER SKYLINER -CENTROLINER CITYLINER LION'S CITY LION'S COACH LION'S REGIO	
54950	81.96320.0168	Silicone Hose ø50xø65x190	-	
54990	-	Silicone Hose ø60x100	-	
54991	81.96301.0594	Silicone Hose ø90x120	10/11.150/180/190/220/230 12220/ 14.280 / 18.220 18.220/260/280/310... 24410/460/24.400/460 MAN 322/352/402/422/462 CENTROLINER CITYLINER LION'S CITY LION'S CLASSIC LION'S COACH LION'S REGIO SKYLINER SL, SG, SUE, RH, UEL SERIES EL, ND, NL, NM, NG SERIES STARLINER TOURLINER TRENDLINER	
54992	81.96301.0600	Silicone Hose ø100x130	18.230/250/270/280 28,270 LION'S CITY LION'S CLASSIC MAN 322/352/402/422/462 NG, NL, RH, GS SERIES SG, SL, SUE, UEL SERIES	
54993	81.96320.0132	Silicone Hose ø100x180	18.220/290/310/350/370/400/420/ 460 22/24.330-420 F 90	







Auger Nr.	OEM Nr.	Description	Model	Picture
54994	-	Silicone Hose ø50x70	-	
54995	51.96301.0108	Silicone Hose ø50x110	-	
54996	-	Silicone Hose ø57x110	-	
54997	81.90632.0170	Silicone Hose ø65x110	-	
54998	-	Silicone Hose ø26x60	-	
54999	51.96330.0190	Silicone Hose ø75x120	-	







Auger Nr.	OEM Nr.	Description	Model	Picture
55000	81.96301.0624	Silicone Hose ø100x80	18.220/310/313/350/370/400/420/ 460 HOCL/R 28,270 NM 223/283 F SG 28.260/310 SUE 223/253/263/313 RH 352/402/422 LION'S CLASSIC	
55001	51.96330.0359	Silicone Hose ø55x80	-	
55002	-	Silicone Hose ø75x70	-	
55003	-	Silicone Hose ø70x150	-	
55004	-	Silicone Hose ø6x1000	-	
55021	-	Silicone Hose ø60xø70x90	-	







Auger Nr.	OEM Nr.	Description	Model	Picture
55025	81.96305.0134	Silicone Hose ø60x85/85	12.220 14.280 26T 6X6 F 2000 F90 LION'S CITY LION'S COACH LION'S REGIO CENTROLINER TOURLINER STARLINER MAN 322/352/402/422/462 ND, NG, NL, NUE SERIES RH 352/353/402/403/422... SL, SUE, UEL SERIES TGA TGS TGX	
55026	81.96301.0387	Silicone Hose ø38x85/90	CENTROLINER CITYLINER EL, UEL SERIES F2000 F2000 LION'S CITY LION'S CLASSIC LION'S COACH LION'S REGIO MAN 322/352/402/422/462 ND, NL, NG SERIES NM 223/283 SL, SD, SG, RH SERIES STARLINER TOURLINER TRENDLINER	
55027	-	Silicone Hose ø60x80/165	-	
55028	-	Silicone Hose ø60x75/75	-	
55029	-	Silicone Hose ø60x70/110	-	

Auger Nr.	OEM Nr.	Description	Model	Picture
51529	51.90001.0167	Exhaust Manifold Bolt	D2566	
	51.90001.0122		D2842	
	51.90430.0046	M10x1.5/75	D2866	
51530	51.90001.0169	Exhaust Manifold Bolt	D0226	
	51.90430.0044		D0824	
		M10x1.5/55	D0826	
			D2530	
			D2565	
			D2566	
			D2866	
			G0826	
51540	51.90490.0029	Exhaust Manifold Bolt	D0824	
	51.90001.0168		D0826	
	51.90490.0033	M10x1.5/50	D0834	
			D0836	
			D2840	
			D2866	
51541	51.90490.0030	Exhaust Manifold Bolt	D0824	
	51.90001.0156		D0826	
	51.90001.0166	M10x1.5/55	D0834	
			D0836	
			D2565	
			D2566	
			D2840	
			D2842	
			D2866	
			E2866	
		F 2000		
		G2866		
		ÖAF		
51419	81.96210.0101	Rubber Mounting for Exhaust	12220 - 14220/280 - 15220/15240	
			30/32/33/34/281/291/321/331/361	
			322/352/402/422/462 FRH	
			CENTROLINER	
			F 2000 - F 90	
			LION'S CITY - LION'S CLASSIC	
			LION'S COACH - LION'S STAR	
			MAN 292/332/362 HF	
			ND 313/363	
			NG 232/235/252/262/263/272/312/313	
			NL202/213/205/222/223/232/240/242/243/250	
			/252/262/283/310/312/313	
			NL/NUE 263/313/353 - NM 223/283	
			ÖAF - TGA	
			RH 353/403/463	
			SG 242/292/322 - SG 28.260/310	
			SL 18.220/260/280 - SL 200/202	
	SR 240/280			
	STARLINER - TOURLINER			
	SUE 223/240/242/280/290/253/263/313			
	UEL 242/272/292/312/313/322/353			

Auger Nr.	OEM Nr.	Description	Model	Picture
51424	81.96210.0052 81.96210.0301	Rubber Mounting for Exhaust M8/ø40x30	10/11.150/180/190/220/230 322/352/402/422/462 FRH 8/9.136/170 F 2000 - F 90 - G 90 - L 2000 LION'S CITY - CENTROLINER M 90 - M2000 L - M2000 M MAN 292 ND 202/313/363 FR - NG 232/242/252/262/263/272/312/313 NL 202/213/222/223/ 232 /250/252/262/ 263/310/312/313/353 NM 152/223/283 NUE 263/313/353 ÖAF RH 352/353/402/403/422 SD 202 F - SG 242/280/292/322 SL 200/202 SR 240/280 - SUE 240/242/280/290 TGA UEL 242/272/292/312/322	
51428	81.96210.0153 81.96210.0127	Rubber Mounting for Exhaust M10/ø50x30	16.220/240/280/281/290/291/321/331/360/ 361/370/372 17.220/240 18.220/290/370 FOC/R-SKD-RSA 19.240/281/291/321/331/361 22/24.330-420 22/24/25/26/291/331/361 26/32.240/281/301/321 28.270 30/32/33/34.281/291/321/331/361 CENTROLINER F 2000 F 90 L 2000 LION'S CITY M 2000 M NG 263/313 F NL 223/242 /243/283 NL/NUE 263/313/353 ÖAF RH 403/463 SD 202 F SG 28.260/310 SUE 223/242/253/263/313 TGA	
51429	81.96210.0130	Rubber Mounting for Exhaust M10/ø50x45	19240 26/32.240 F 2000	
51425	81.96210.0289 83.96210.0508	Air Filter Mounting M8/ø30x20	18.220/230/250 EL 202/222/262 F 90 LION'S CITY - LION'S CLASSIC M 2000 NL 202/213/222/250/262/312 ÖAF SL 200 - SR 240/280-12 M RUE 240/280 - SUE 240/280 TGA	

Auger Nr.	OEM Nr.	Description	Model	Picture
52534	81.74821.0095	Gas Spring 720 mm/220 N	18.220/290/370 F 2000 F 90 M 2000 M 90 ÖAF	
52647	81.61140.0016	Gas Spring 685 mm/200N	ECT18/26 TGA	
52648	81.61130.6500	Gas Spring 350 mm/220 N	-	
54455	81.74821.0068	Gas Spring 925 mm/380 N	EL 202 EL 202/222/262 NG 232 NG 272 NG 242/252/262/272/312 NL 202 NL 213/222/250/262/312 NL232 NM 152 R/FRH 292/332/362	
54456	81.62900.6179	Gas Spring 147 mm/350 N	TGS TGX TGA ECT18/26T	
54457	81.74821.0041	Gas Spring 425 mm/200 N	EL 202/222/262 F 90 LION'S CITY NG NG 232/242/252/262/272/312 NL 202 NL 202/213/222/250/262/312 NL232 NM 152 SG 242/280/282/292/322 SL 200/202 SUE 240/242/280	
54458	81.74821.0065	Gas Spring 138 mm/60 N	322/352/402/422/462 FRH 10/11.150/180/190/220/230 CENTROLINER EL 202/222/262 F 90 GOEPEL-AUFBAU GS UEH 270/290/320/370 LION'S CITY NG 232/242/243/252/262/272/312 NGT 204 NL 202/213/222/250/252/262/312 NL 223/232/243/263 NM 152 OAF SG 242/280/282/292/322 SL 202 SR 240/280 SUE 240/242/280 UEL 242/272/292/312/322	

Auger Nr.	OEM Nr.	Description	Model	Picture
54459	81.74821.0110	Gas Spring 278 mm/50 N	CENTROLINER F 2000 F 90 LION'S CITY NG 243 NL223 NL243 NL263 ÖAF	
54460	81.74821.0107 81.74821.0108	Gas Spring 290 mm/600 N	ÖAF F 2000 F 90	
54461	81.74821.0039	Gas Spring 425 mm/350 N	TGX TGS TGA 16/19/281/291/321/331/361 22/24/25/26.220/240 22/24/25/26.281/291/321/331/361 22/24/25/26.291/331/361 26/27/32/33/34.281/291/321/331/361 26/32/33/34.281/291/321/331/361 CENTROLINER ECT18 EL 202/222/262 F 2000 F 90 GOEPPEL-AUFBAU LION'S CITY NG 232/242/252/262/272/312 NL 202/213/222/223/250/262/263/312 NM 152 SG 242/280/282/292/322 SL 200/202 SR 240/280 SUE 240/242/280	
54462	81.74821.0104	Gas Spring 315 mm/250 N	CENTROLINER F 2000 F 90 LION'S CITY M 2000 M 90 NL223 NL263 ÖAF	
54463	81.74821.0063	Gas Spring 700 mm/350 N	16.240/290/370 CENTROLINER GS UEH 270/290/320/370 LION'S CITY - LION'S COACH LION'S REGIO - LION'S STAR MAN 292 NG NG 243/263/313 NL 202/222/252/262/312 NL 223/263/313 SR 240/280 TOURLINER - TRENDLINER UEL 242/272/292/312/322 UEL 313/353	
54464	81.74821.0084	Gas Spring 425 mm/100 N	12.220 12/14.220 NL 223/263/313 NM 223/283 SG 242/282 SG 242/292/322 SL 202 SUE 242	

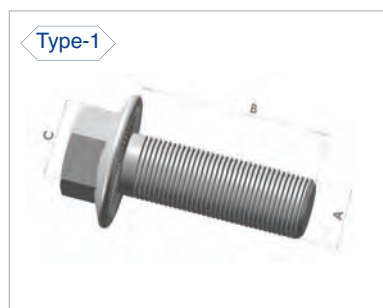

Auger Nr.	OEM Nr.	Description	Model	Picture
54465	81.74821.0048	Gas Spring 920 mm/350 N	322/352/402/422/462 FRH EL 202/222/262 LION'S CITY MAN 292/332/362 NG 232 NG 242/272 NG 252/262/272/312 NL 202/213/222/250/262/312 NL232 NM 152	
55085	81.74821.0141 81.97006.0016	Gas Spring 276mm/400N	TGS TGX TGA ECT 18/26T TGL TGM	
55086	81.97006.0001 81.74821.0148	Gas Spring 315mm/120N	18.310/350/370/400/420/460 HOCL/R 18260/410/460 HOCL/R 24410/460 HOCLN/R-15M CITYLINER ECT 18T/26T LION'S CITY LION'S CLASSIC LION'S COACH LION'S REGIO LION'S STAR STARLINER TGA TGL TGM TGS TGX TOURLINER TRENDLINER	
55087	81.74821.0140	Gas Spring 345mm/450N	TGX TGS TGA ECT 18T/26T	
55088	81.97006.0020	Gas Spring 484mm/50N	TGS TGX	
55089	81.74821.0131	Gas Spring 650mm/250N	F 2000 ÖAF	

Auger Nr.	OEM Nr.	Description	Model	Picture
55090	81.74821.0109	Gas Spring 580mm/260N	F2000 F90 M2000 ÖAF	
55091	81.74821.0149 81.74821.0146 81.74821.0144	Gas Spring 485mm/50N	TGS TGX TGA ECT 18T/26T TGL TGM	
55092	81.97006.0002	Gas Spring 685mm/160N	TGS TGX TGA ECT 18T/26T TGL TGM	
55093	81.97006.0003	Gas Spring 785mm/150N	TGS TGX TGA ECT 18T/26T TGL TGM	
55094	81.97006.0019	Gas Spring 210mm/1000N	TGX TGA	
55101	81.97006.0010	Gas Spring 186mm/50N	TGA TGL TGM TGS TGX ECT 18/26T	



Auger Nr.	O.E.M. Nr.	A	B	C	Type	Repair Kit
51516	06.02815.8812 06.02814.2812 - 06.02813.4812 06.02792.5010 - 06.02791.5010	M12x1.5	35	SW17	1	-
51517	06.02815.8911 06.02792.5109 - 06.02814.2911 06.02813.4911 - 06.02816.0911	M14x1.5	30	SW19	1	-
51518	06.02815.8912 - 06.02814.2912 06.02813.4912 - 06.02792.5110 06.02816.0912 - 06.02791.5110	M14x1.5	35	SW19	1	-
51519	06.02815.8914 - 06.02792.5112 06.02813.4914 - 06.02814.2914 06.02819.0006	M14x1.5	45	SW19	1	-
51522	06.02815.9013 - 06.02791.5211 06.02813.5013 - 06.02792.5211 06.02814.3013 - 06.02816.1013	M16x1.5	40	SW22	1	-
51523	06.02815.9015 06.02792.5213 - 06.02814.3015	M16x1.5	50	SW22	1	-
51526	06.02815.8913 06.02792.5111 - 06.02814.2913	M14x1.5	40	SW19	1	-
51520	06.02815.8916 - 06.02814.2916 06.02813.4916 - 06.02202.0609	M14x1.5	55	SW19	2	-
51521	06.02815.8917 06.02814.2917 - 06.02813.4917	M14x1.5	60	SW19	2	-
51524	06.02815.9017 06.02814.3017	M16x1.5	60	SW22	2	-
51525	06.02815.8915 - 06.02813.4915 06.02814.2915 - 06.02813.4913	M14x1.5	50	SW19	2	-
51527	06.02813.4919 06.02814.2919 - 06.02815.8919	M14x1.5	70	SW19	2	-
51528	06.02815.9022 06.02814.3022 - 06.02813.5022	M16x1.5	85	SW22	2	-
51532	06.11251.8108 06.11251.2108	M16x1.5	16	SW22	3	53288-53290 55126-55134
51533	06.11251.2105 06.11251.8105 - 06.11251.2005	M14x1.5	14	SW19	3	-

Auger Nr.	OEM Nr.	Description	Model	Picture
55517	81.30560.0057 81.30560.0063	Clutch Release Fork	322/352/402/422/462 FRH 14.280, 16.240/290/370 18.220/230/250/280/290/370 18.310/313/350/370/400/420 18.310/350/360/400/410 18.310/350/370/400/420/460 18.260/410/460, 22/24.330-420 24.350/400, 24.400/460 24.410/460, 28.270 CENTROLINER, CITYLINER EL 202/222/262 F 2000, F 90, ÖAF, TGA LION'S CITY, LION'S CLASSIC LION'S COACH, LION'S REGIO NL 223/263/313 RH 353/403/403/463 SL 18.220/260/280 SUE 223/242/253/263/313 TOURLINER TRENDLINER UEL 242/272/292/312/322 UEL 313/353	
55518	81.32411.0007 81.32411.0006	Clutch Release Fork	TGS TGX TGA F 2000 F 90 ÖAF 26T6X6	
55519	81.30560.6019 81.30560.6022	Rep. Kit for Clutch Release Fork	TGA, TGL, TGM, TGS, TGX F 2000, F 90, M 2000, L 2000 ECT 18/26T, ÖAF 14.280, 18.220/230/250/290/310/370 18.310/313/350/370/400/420 18.310/350/370/400/420/460 18.260/410/460 24.350/400, 24.400/410/460, 28.270 CENTROLINER, CITYLINER LION'S CITY, LION'S CLASSIC LION'S COACH, LION'S REGIO TOURLINER, TRENDLINER EL 202/222/262, NL 223/263/313 RH 353/403 RH 403/463 SL 18.220/260/280 SUE 223/253/263/313 SUE 242 UEL 242/272/292/312/322 UEL 313/353	
55520	81.30560.0055	Pivot	TGA, TGL, TGM, F 2000, F 90 L 2000, M 2000, ÖAF 322/352/402/422/462 FRH 14.280, 16.240/290/370 18.220/230/280/250 18.220/230/250/290/370 18.310/313/350/370/400/420 18.310/350/370/400/420/460 18.260/410/460, 22/24.330-420 24.350/400, 24.400/460 24.410/460, 28.270 CENTROLINER, CITYLINER EL 202/222/262 LION'S CITY, LION'S CLASSIC LION'S COACH, LION'S REGIO NL 223/263/313 RH 353/403, RH 403/463 SL 18.220/260/280 SUE 223/242/253/263/313 TOURLINER TRENDLINER UEL 242/272/292/312/322 UEL 313/353 UEL 313/353	

Auger Nr.	OEM Nr.	Description	Model	Picture
55521	81.32404.0002	Pivot	TGS TGX TGA F 2000 F 90 F 2000 ÖAF	
55522	81.30560.0061	Clutch Release Fork	TGA TGL TGM L 2000 M 2000 18.220/290/370	
55523	81.30560.0050	Clutch Operating Lever	16.240/280/290/360/372 16.240/290/370 16.360/372 16/19.281/291/321/331/361 22/24.330-420 22/24/25/26.281/291/321/331/361 26/27/32/33/34.281/291/321/331/361 26/32.281/301/321 26/32.365 26/32/33/34.281/291/321/331/361 30/32/33/34.281/291/321/331/361 D2866 GS UEH 270/290/320/370 MAN 292/332/362 SL 202 SR 240/280 SUE 240/280 SUE 242 UEL 242/272/292/312/322	
55525	81.30560.0041	Clutch Release Fork	SR 280 SR 240/280 SR 280 SUE 240/280	