

# 03

## VOLVO

Group	Page
Spring Suspension . . . . .	001
Cabin . . . . .	017
Stabilizer . . . . .	023
Brake . . . . .	033
Axle & Wheel . . . . .	040
Steering & Suspension . . . . .	046
Engine . . . . .	074
Shaft . . . . .	075
Gearbox . . . . .	075
Radiator & Fan Group . . . . .	076
Shock Absorber & Gas Spring . . . . .	081
Gas-Pedal . . . . .	082
Exhaust . . . . .	083
Oil & Air Filter . . . . .	083
Air Suspension . . . . .	083
Clutch . . . . .	085





Auger Nr.	OEM Nr.	Description	Model	Picture	
<b>51452</b>	6879 332	Rubber Bushing for Spring  ø16xø50x95	FL 6 FL 608-615 B6		
<b>51668</b>	3027 227	Rubber Bushing for Spring  ø20xø55.5x120	FE 6 FL 616-619		
<b>53298</b>	3111 274	Rubber Bushing for Spring  ø13xø60.5x73	"B 10 B, B 10 BLE" B 10 L B 12 B B 6 BLE B 7 L B 7 L DD B 7 R OLYMPIAN MKII SUPEROLYMPIAN		
<b>53300</b>	7030 8561 3112 049	Rubber Bushing for Spring  ø16xø70x82.5	"B 10 B, B 10 BLE" B 10 L B 12 B B 6 BLE B 7 L B 7L DD B 7 R SUPEROLYMPIAN		
<b>54210</b>	2053 3294	Rubber Bushing for Spring  ø20.5xø52.5x110	FH 12 FH 16 FM 12 FM 9		
<b>51684</b>	1624 486	Rubber Bushing for Spring  ø26xø55x111.5	FH 12 FH 12 BR FH 12 J FH 16 FH 16 J FL 6 FM 10 FM 10 BR FM 12	FM 12 BR FM 7 FM 9 NH 12 NH 12 BR	
<b>52359</b>	1696 042	Rubber Bushing for Spring  ø24xø59x107	F 10 F 12		
<b>55508</b>	2083 9455	Rubber Bushing for Spring  ø24xø61.5x87	726; 09, FE, 4*2, RSS-AIR; TB-96662086-3  726; 09, FE, 6*2, RSS-AIR; TB-96662040-3		

Auger Nr.	OEM Nr.	Description	Model	Picture
<b>53301</b>	1626 139	Spring Buffer 85x140x11/16	FH 12 FH 12 BR FH 16 FM 10 FM 10 BR FM 12 FM 12 BR FM 7 FM 9	NH 12 NH 12 NH 12 BR 
<b>51679</b>	1591 299 1598 391 1628 397	Spring Buffer 90x100x11	B 7 B 7 F B 7 R F 10 F 12 F 16 FE 6 USA FE 7 USA FL 10	FL 12 FL 6 FL 616-619 FL 7 NL 10 AUS NL 10 S NL 12 AUS NL 12 S 
<b>51680</b>	6775 502	Spring Buffer 70x80x11	F6 USA FE 7 USA FL 6 FL 608-615 FL 616-619 FS 7	
<b>51686</b>	1580 214	Spring Buffer M12x52	F 10 F 12 F 16 F 7 USA FL 10 FL 12 FL 7 FM 12 FM 9 N 10	N 10 USA N 12 N 12 USA NL 10 AUS NL 10 BR NL 10 S NL 12 AUS NL 12 BR NL 12 S 
<b>51682</b>	351 111	Spring Buffer 60x100x40	B 7 B 7 F B 7 R F 10 F 12 F 16 F 6 USA FE 6 USA FE 7 USA FH 12 FH 12 BR FH 16 FL 10	FL 12 FL 6 FL 608-615 FL 616-619 FL 7 FLC FM 10 FM 10 BR FM 12 FM 7 FM 9 FS 7 N 10 N 12 NH 12 NH 12 BR NL 10 AUS NL 10 BR NL 10 S NL 12 AUS NL 12 BR 
<b>51666</b>	1628 449	Spring Buffer ø96x92	FH 12 BR FH 12 FH 12 J FH 16 FH 16 J FL 608-615 FM 10 FM 10 BR FM 12	FM 12 BR FM 7 FM 9 NH 12 NH 12 BR 
<b>51685</b>	1506 399 354 149	Spring Buffer 96x118	B 7 B 7F F 10 F 12 F 16 F 7 USA FH 12 FH 16 FL 10 FL 12 FL 6 FL 608-615 FL 616-	619 FL 7 FLC FM 10 FM 12 FM 7 FM 9 FS 7 N 10 N 10 USA N 12 N 12 USA NH 12 NH 12 BR NL 10 AUS NL 10 BR NL 10 S NL 12 AUS NL 12 BR NL12 S 

Auger Nr.	OEM Nr.	Description	Model	Picture
<b>51630</b>	6772 290	Silent Block ø45.5 x100/171	FE 6 USA FL 6 FL 616-619	
<b>51631</b>	1501 677	Silent Block ø51x100/178.5	F 10 F 12 F 16 F 7 USA FL 10 FL 12 FL 7 N 10 N 10 USA N 12 N 12 USA NL 10 AUS	NL 10 BR NL 10 S NL 12 AUS NL 12 BR NL 12 S 
<b>51632</b>	343 348	Silent Block ø51x89/167	---	
<b>51626</b>	6850 876	Silent Block ø45.5x100/161	FE 6 USA FE 7 USA FL 6 FL 616-619	
<b>51627</b>	6850 875	Silent Block ø45.5x80/140	F 6 USA FE 6 USA FL 6 FL 608-615 FLC	
<b>51628</b>	6850 874	Silent Block ø40.5x70/130	---	
<b>51629</b>	6771 007	Silent Block ø45.5x80/151	FE 6 USA FE 7 USA FL 6 FL 608-615	

Auger Nr.	OEM Nr.	Description	Model	Picture		
<b>51662</b>	1586 089	Spring Cushion	F10			
	1587 103		F12			
	1580 080	h:150	N10 USA N12 USA			
<b>51663</b>	1609 657	Spring Cushion	F 10			
	1577 873		F 12			
	8151 413	h:151	F 16			
	1622 982		FL 10			
			FL 7 N 10 USA N 12 USA NL 10 AUS NL 10 S NL 12 AUS NL 12 S			
<b>51665</b>	1629 553	Spring Cushion	F 10	FM 10 BR	NH 12	
	3090 971		F 12	FM 12	NH 12 BR	
	1089 501	h:151	F 16	FM 12 BR	NL 10 AUS	
	2039 0836		FH 12	FM 7	NL 10 BR	
			FH 12 BR	FM 9	NL 10 S	
			FH 16	FM 10	NL 12 AUS	
			FH 16 J	N 10	NL 12 BR	
			FL 10	N 10 USA	NL 12 S	
			FL 12	N 12		
			FL 6	N 12 USA		
			FL 7	NH 12		
	<b>53295</b>	1590 885	Bogie Suspension Bushing  ø130xø135x80	F 10	FM 7	
F 12				FM 9		
F 16				N 10		
FH 12				NL 10 S		
FH 16				NL 12 S		
FL 10						
FL 12						
FL 6						
FL 7						
FM 10						
FM 12						
<b>53297</b>				1593 431 1590 886	Thrust Washer  ø136xø175x2.5	F 10
	F 12	FM 9				
	F 16	N 10				
	FH 12	NH 12				
	FH 16	NH 12 BR				
	FH 16 J	NH 12				
	FL 10	NL 10 S				
	FL 12					
	FL 6					
	FL 7					
	FM 10					
	FM 12					
<b>52820</b>	1502 292	Cap  ø9x204.5/ø229x37	F 10	FM 10 BR	NL 12 AUS	
			F 12	FM 12	NL 12 BR	
			F 16	FM 12 BR	NL 12 S	
			FH 12 BR	FM 7		
			FH 12	FM 9		
			FH 16	N 10		
			FH 16 J	NH 12		
			FL 10	NH 12 BR		
			FL 12	NH 12		
			FL 6	NL 10 AUS		
			FL 7	NL 10 BR		
			FM 10	NL 10 S		

Auger Nr.	OEM Nr.	Description	Model	Picture		
<b>51690</b>	1581 543	Plastic Bearing ø130xø134x81.5	F 10 F 12 F 16 FH 12 FH 12 BR FH 16 FH 16 J FL 10 FL 12 FL 7 FM 10 FM 10 BR FM 12	FM 12 BR FM 7 FM 9 N 10 USA N 12 USA NH 12 NH 12 BR NL 10 AUS NL 12 AUS NL 12 BR NL 10 BR NL 10 S NL 12 S		
<b>51691</b>	1620 443	Plastic Bearing ø130xø134x67	FH 12 BR FH 12 FH 16 FL 6 FM 10 FM 10 BR FM 12 FM 12 BR FM 7 FM 9 NH 12 NH 12 BR			
<b>52536</b>	1593 522	Seal Ring ø163xø177x11	F 10 F 12 F 16 FH 12 FH 12 BR FH 16 FH 16 J FL 10 FL 12 FL 6 FL 7	FM 10 FM 10 BR FM 12 FM 12 BR FM 7 FM 9 N 10 USA N 12 USA NH 12 NH 12 BR NL 10 AUS	NL 10 BR NL 10 S NL 12 AUS NL 12 BR NL 12 S	
<b>52537</b>	1586 520	Seal Ring ø160xø183x11	F 10 F 12 F 16 FH 12 FH 12 BR FH 16 FH 16J FL 10 FL 12 FL 6 FL 7 FM 10	FM 10 BR FM 12 FM 12 BR FM 7 FM 9 NH 12 NH 12 NH 12 BR NL 10 AUS NL 10 BR NL 10 S NL 12 AUS	NL 12 BR NL 12 S	
<b>52818</b>	1620 742	Gasket ø186.5xø227.5x0.5	F 10 F 12 F 16 FH 12 BR FH 12 FH 16 FH 16 J FL 10 FL 12 FL 6 FL 7 FM 10 FM 10 BR FM 12	FM 12 BR FM 7 FM 9 N 10 NH 12 NH 12 BR NH 12 NL 10 AUS NL 10 BR NL 10 S NL 12 AUS NL 12 BR NL12 S		
<b>52819</b>	1590 508	Gasket ø191xø224x4	F 10 F 12 F 16 FH 12 BR FH 12 FH 16 FH 16 J FL 10 FL 12 FL 6 FL 7 FM 10 FM 10 BR FM 12	FM 12 BR FM 7 FM 9 NH 12 NH 12 BR NH 12 NL 10 AUS NL 10 BR NL 10 S NL 12 AUS NL 12 BR NL 12 S		



Auger Nr.	O.E.M. Nr.	A	B	Type	Repair Kit
51634	6777 141	M36x3	150.5	1	54262
51635	6781 881	M36x3	171	1	54261
51640	6795 567	M36x3	160.5	1	54257
51641	6776 803	M36x3	140.5	1	54255
51642	310 948	M36x3	194	1	52836-54263
51636	1614 229 - 339 465	M36x3	169	2	52840-54258
51637	1614 230 - 1589 024	M36x3	169	2	52834
51638	1076 334	33x4	170	2	54260
51639	1075 723	33x4	170	2	54259
51657	1609 960 - 363 910	M36x3	210	2	52835
52808	351 190	M27x3	121.5	2	-
54209	2042 7987	33x4	201	2	-



Auger Nr.	O.E.M. Nr.	A	B	C	Type	Repair Kit
51643	1608 018 - 1598 762	ø25	M45x3	152.5	1	52839
51644	1608 019 - 1598 761	ø25	M45x3	112	1	52837-52838
51645	1587 940	ø25	M36x3	112	1	54250
51646	6776 802	ø20	M36x3	92.5	1	53303
51647	6782 621	ø20	M36x3	112	1	53302-54251
51648	310 947	M36x3	ø45	109.5	2	54258-54263
51649	1504 550	M36x3	ø45	104.5	2	52834-52835-52836 52840-54250
51650	1075 726	33x4	ø45	105	2	54259-54260
51651	1598 721	M45x3	ø55	104.5	2	52837-52838-52839
51652	6776 801	M36x3	ø45	79.5	2	53303-54255-54262
51653	6781 880	M36x3	ø50	99.5	2	53302-54257-54261 54251
52809	330 135	M36x3	ø45	83	2	-



Auger Nr.	OEM Nr.	Description	Model	Picture	
<b>51634</b>	6777 141	Spring Pin M36x3/150.5	FE 6 USA FE 7 USA FL 6 FL 608-615 FL 616-619 FS 7		
<b>51635</b>	6781 881	Spring Pin M36x3/171	FL 6 FL 616-619 FS 7		
<b>51636</b>	1614 229 339 465	Spring Pin M36x3/169	F 10 F 12 F 16 F 7 USA FH 12 FH 12 J FH 16 FH 16 J FL 10 FL 12 FL 7 N 10	N 12 USA NL 10 AUS NL 10 S NL 12 AUS NL 12 S	
<b>51637</b>	1614 230 1589 024	Spring Pin M36x3/169	F 10 F 12 F 16 FH 12 FH 12 J FH 16 FH 16 J FL 10 FL 12 FL 7 N 10	N 10 USA N 12 N 12 USA NL 10 AUS NL 10 BR NL 10 S NL 12 AUS NL 12 BR	
<b>51638</b>	1076 334	Spring Pin Ø38x170	FH 12 BR FH 12 FH 12 J FH 16 FH 16 J FM 10 FM 10 BR FM 12 FM 12 BR FM 7 FM 9 NH 12	NH 12 BR	
<b>51639</b>	1075 723	Spring Pin Ø38x170	FH 12 BR FH 12 FH 12 J FH 16 FH 16 J FM 10 FM 10 BR FM 12 FM 12 BR FM 7 FM 9	NH 12 NH 12 BR NH 12	





Auger Nr.	OEM Nr.	Description	Model	Picture	
<b>51640</b>	6795 567	Spring Pin M36x3/160.5	FL 6 FL 616-619		
<b>51641</b>	6776 803	Spring Pin M36x3/140.5	F 6 USA FE 6 USA FL 6 FL 608-615 FLC		
<b>51642</b>	310 948	Spring Pin M36x3/M20x2.5/194	B 58 BR		
<b>51657</b>	1609 960 363 910	Spring Pin M36x3/210	F 10 F 12 F 16 FH 12 FH 16 FL 10 FL 12 FL 6 FL 75 FM 10 FM 12 FM 7	FM 9 N 10 NL 10 S NL 12 S	
<b>52808</b>	351 190	Spring Pin M27x3/121.5	---		
<b>54209</b>	2042 7987	Spring Pin M34x4/200	FH 12 FH 16 FM 12 FM 9		







Auger Nr.	OEM Nr.	Description	Model	Picture
<b>51643</b>	1608 018 1598 762	Bushing For Spring Pin M45.3/Ø25x152.5	F 10 F 12 F 16 FL 10 FL 12 FL 7	
<b>51644</b>	1608 019 1598 761	Bushing For Spring Pin M45x3/Ø25x112	F 10 F 12 F 16 FH 12 FH 16 FL 10 FL 12 FL 7 FM 10 FM 12 FM 7	FM 9 NH 12 
<b>51645</b>	1587 940	Bushing For Spring Pin M36x3/Ø25x112	F 10 F 12	
<b>51646</b>	6776 802	Bushing For Spring Pin M36x3/Ø20x92.5	F 6 USA FE 6 USA FE 7 USA FL 6 FL 608-615 FLC	
<b>51647</b>	6782 621	Bushing For Spring Pin M36x3/Ø20x112	B 7 B 7 F B 7 R FL 6 FL 616-619 FS 7	
<b>51648</b>	310 947	Bushing For Spring Pin M36x3/Ø45x109.5	B 58 BR F 10 F 12	

Auger Nr.	OEM Nr.	Description	Model	Picture	
<b>51649</b>	1504 550	Bushing For Spring Pin M36x3/ø45x104.5	F 10 F 12 F 16 F 7 USA FH 12 FH 16 FH 16 J FL 10 FL 12 FL 6 FL 7 FM 10	FM 12 FM 7 FM 9 N 10 N 10 USA N 12 N 12 USA NL 10 AUS NL 10 BR NL 10 S NL 12 AUS NL 12 BR	
<b>51650</b>	1075 726	Bushing For Spring Pin ø45x105	FH 12 FH 12 BR FH 12 J FH 16 FH 16 J FM 10 FM 10 BR FM 12 FM 12 BR FM 7 FM 9	NH 12 NH 12 BR	
<b>51651</b>	1598 721	Bushing For Spring Pin M45x3/ø55x104.5	F 10 F 12 F 16 FH 12 FH 16 FL 10 FL 12 FL 7 FM 10 FM 12 FM 7 FM 9	NH 12	
<b>51652</b>	6776 801	Bushing For Spring Pin M36x3/ø45x79.5	B 10 B, B 10 BLE F 6 USA FE 6 USA FE 7 USA FL 6 FL 608-615 FL 616-619 FLC FS 7		
<b>51653</b>	6781 880	Bushing For Spring Pin M36x3/ø50x99.5	B 7 B 7 F B 7 R FL 6 FL 616-619 FS 7		
<b>52809</b>	330 135	Bushing For Spring Pin M36x3/ø45x83	---		



Auger Nr.	O.E.M. Nr.	A	B	C	Type	Repair Kit
51670	1598 764 - 1576 943	M24x3	159.5	SW 36	1	52837- 54245- 54250
51671	1598 765	M24x3	221	SW 36	1	52839- 54246
51672	1598 766 - 1622 502	M24x3	171.5	SW 36	1	52838- 54247
51673	6795 968	M20x2.5	155	SW 30	1	53302- 54243
54208	2088 3938	M20x2.5	155	SW 27	1	-
54791	3136 427	M20x2.5	147	SW 30	1	54251
54792	1626 577	M24x3	206	SW 24	1	54254
54801	963 323	M16x2	120	SW 24	1	54252
54802	955 400 - 6781 560 - 963 348	M20x2.5	159	SW 30	1	54253
51674	6776 804	M20x2.5	127	SW 30	1	53303- 54244
51677	955 377 - 963 324	M16x2	130	SW 24	1	54242- 54249
55277	2046 7715	M20x2.5	223	SW 27	1	55060
52806	961 997	M24x3	21.5	SW 36	2	52837- 52838- 52839 54245- 54246- 54247 54250-54254
53299	948 835	M20x2.5	20	SW 30	3	53302- 53303- 54243 54244- 54251- 54253
51687	125 021	$\varnothing 41.2$	$\varnothing 5.3$	-	4	54258- 54263

Auger Nr.	OEM Nr.	Description	Model	Picture
51670	1598 764 1576 943	Spring Pin M24x3/160	F 10 F 12 F 16 FL 10 FL 12 FL 7	
51671	1598 765	Spring Pin M24x3/221	F 10 F 12 F 16 FL 10 FL 12 FL 7	
51672	1598 766 1622 502	Spring Pin M24x3/172	F 10 F 12 F 16 FH 12 FH 16 FL 10 FL 12 FL 7	FM 10 FM 7 FM 9 FM12 NH 12 
54208	2088 3938	Spring Pin M20x2.5/155	FH 12 FH 16 FM 9 FM 12 NH 12	

Auger Nr.	OEM Nr.	Description	Model	Picture		
<b>54242</b>	955 377 S 963 324 S	Rep. Kit Spring Bolt Assembly  M16x2/130	B 6 F 10 F 12 F 16 F 16 FH 12 FH 16 FL 608- 615 FL 616- 619	FL 10 FL 12 FL6 FL7 FLC FM 10 FM 12 FM 12/FM9 FAA11 FM 7	FS 7 N 10 N 12 NH 12 NH 12 BR NL 10 BR NL 10 S NL 12 BR NL 12 S	
<b>54243</b>	6795 968 S	Rep. Kit Spring Bolt Assembly  M20x2.5/155	FL 6 FL 616-619			
<b>54244</b>	6776 804 S	Rep. Kit Spring Bolt Assembly  M20x2.5/127	FE 6 USA FE 7 USA FL 6 FL 608-615			
<b>54245</b>	1598 764 S 1576 943 S	Rep. Kit Spring Bolt Assembly  M24x3/160	F 10 F 12 F 16 FL 10 FL 12 FL 7			
<b>54246</b>	1598 765 S	Rep. Kit Spring Bolt Assembly  M24x3/221	F 10 F 12 F 16 FL 10 FL 12 FL 7			
<b>54247</b>	1598 766 S 1622 502 S	Rep. Kit Spring Bolt Assembly  M24x3/172	F 10 F 12 F 16 FH 12 FH 16 FL 10 FL 12 FM 10 FM 12 FM 7 FM 9	NH 12		

Auger Nr.	OEM Nr.	Description	Model	Picture
<b>54249</b>	6879 332 S	Rep. Kit Spring Bolt Assembly  ø16xø50x95	B 6 FL 6 FL 608-615	
<b>54250</b>	---	Rep. Kit Spring Bolt Assembly  M36x3	F 10 F 12	
<b>54251</b>	---	Rep. Kit Spring Bolt Assembly  M20x2.5/147	B 7 B 7 F B 7 R FL 6 FL 616-619 FS 7	
<b>54252</b>	6879 332 S1	Rep. Kit Spring Bolt Assembly  ø16xø50x95	FE 6 FL 608-615 FL 616-619 FS 7	
<b>54253</b>	3027 227S	Rep. Kit Spring Bolt Assembly  ø20xø55.5x120	FL 616-619	
<b>54254</b>	1624 486 S	Rep. Kit Spring Bolt Assembly  ø26xø55x111.5	FH 12 FH 12 BR FH 12 J FH 16 FH 16 J FM 10 FM 10 BR FM 12 FM 7 NH 12 NH 12 BR	

Auger Nr.	OEM Nr.	Description	Model	Picture
<b>55060</b>	2053 329 4S	Rep. Kit Spring Bolt Assembly  ø20.5xø52.5x110	FH 12 FH 16 FM 9 FM 12	
<b>52837</b>	---	Rep. Kit Spring Bolt Assembly  M45x3	F 10 F 12 F 16 FL 10 FL 12 FL 7	
<b>52838</b>	---	Rep. Kit Spring Bolt Assembly  M45x3	F 10 F 12 F 16 FL 10 FL 12 FL 7	
<b>52839</b>	---	Rep. Kit Spring Bolt Assembly  M45x3	F 10 F 12 F 16 FL 10 FL 12 FL 7	
<b>53302</b>	---	Rep. Kit Spring Bolt Assembly  M20x2.5/155	B 7 B 7 F B 7 R FL 6 FL 616-619 FS 7	
<b>53303</b>	---	Rep. Kit Spring Bolt Assembly  M20x2.5/127	F 6 USA FE 6 USA FE 7 USA FL 6 FL 608-615 FLC	
<b>52834</b>	---	Spring Pin Set  M36x3	F 10 F 12 F 16 FH 12 FH 16 FH 16 J FL 10 FL 12 FL 7 N 10 N 10 USA	



Auger Nr.	OEM Nr.	Description	Model		Picture	
<b>52835</b>	---	Spring Pin Set M36x3	F 10 F 12 F 16 FH 12 FH 16 FL 10 FL 12 FL 6	FL 7 FM 10 FM 12 FM 7 FM 9 N 10 NL 10 S NL 12 S		
<b>52836</b>	---	Spring Pin Set M36x3	F 10 F 12 F 16 F 7 USA FH 12 FH 16 FH 16 J FL 10 FL 12 FL 7 N 12 USA	FL 6 FL 7 FM 10 FM 12 FM 7 FM 9 N 10 N 10 USA N 12	N 12 USA NL 10 AUS NL 10 BR NL 10 S NL 12 AUS NL 12 BR NL 12 S B 58 BR	
<b>52840</b>	---	Spring Pin Set M36x3	F 10 F 12 F 16 F 7 USA FH 12 FH 16 FH 16 J FL 10 FL 12 FL 7 N 12 USA	NL 10 AUS NL 10 S NL 12 AUS NL 12 S		
<b>54255</b>	---	Spring Pin Set M36x3	F6 USA FE 6 USA FL 6 FL 608-615 FLC			
<b>54256</b>	---	Spring Pin Set ø45.5	FE 6 USA FL 6 FL 616-619			
<b>54257</b>	---	Spring Pin Set M36x3	FL 6 FL 616-619			
<b>54258</b>	---	Spring Pin Set M36x3	F 10 F 12			

Auger Nr.	OEM Nr.	Description	Model	Picture
<b>54259</b>	---	Spring Pin Set	FH 12 FH 12 BR FH 12 J FH 16 FH 16 J FM 10 FM 10 BR FM 12 FM 12 BR FM 7 FM 9	NH 12 NH 12 NH 12 BR 
<b>54260</b>	---	Spring Pin Set	FH 12 FH 12 BR FH 12 J FH 16 FH 16 J FM 10 FM 10 BR FM 12 FM 12 BR FM 7 FM 9	NH 12 NH 12 BR 
<b>54261</b>	---	Spring Pin Set M36x3	FL 6 FL 616-619 FS 7	51635 51653 
<b>54262</b>	---	Spring Pin Set M36x3	FE 6 USA FE 7 USA FL 6 FL 608-615 FL 616-619 FS 7	51634 51652 
<b>54263</b>	---	Spring Pin Set M36x3	B 58 BR	51648 51687 51642 
<b>51678</b>	3171 036	Spring Bracket 65.5x160x28.5	FH 12 BR FH 12 FH 12 J FH 16 FH 16 FH 16 J FM 10 FM 10 BR FM 12 FM 12 BR	FM 7 FM 9 NH 12 
<b>52664</b>	1598 824	Spring Bracket h: 178	F10 F12 FL7 FL10 FL12	



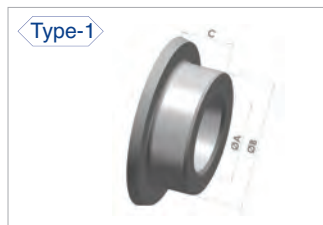



Auger Nr.	OEM Nr.	Description	Model	Picture
<b>51697</b>	8152 645 1570 910	Cabin Bushing  ø40.5xø50x27.5	F 10 F 12 F 16	
<b>51700</b>	2039 0840	Cabin Bushing  ø16xø90x70	FH 12 FM 10 FM 10 BR FM 12 FM 12 BR FM 7 FM 9	
<b>51698</b>	8143 461	Cabin Bushing  ø64xø68x21.5	FH 12 BR FH 12 FH 12 J FH 16 FH 16 J	
<b>51699</b>	1075 266 8143 460	Cabin Mounting  ø30xø68x49	FH 12 BR FH 12 FH 12 J FH 16 FH 16 J	
<b>53132</b>	1591 039	Cabin Mounting  ø28.5xø59x60	FL 10 FL 12 FL 7	
<b>52826</b>	1096 625	Buffer for Cabin  ø51x50	FH 12 BR FH 12 FH 12 J FH 16 FH 16 J	
<b>52831</b>	1629 726	Buffer for Cabin  ø51x50	FH 12 BR FH 12 FH 12 J FH 16 FH 16 J	









Auger Nr.	O.E.M. Nr.	A	B	C	Type	Repair Kit
52816	8142 168	ø25	ø40	17	1	52841
52828	1075 699	ø17.8	ø30	59	2	52358
54832	8140 869	ø40.5	ø44.5	9	3	52841- 54240
52814	8142 699	M12x1.75	210	SW 10	4	52841- 54240
52815	1075 399	ø13	ø25	183	5	52841
52829	980 547	M16x2	100	SW 21	6	52358
52817	1075 341	ø16.5	ø91	5	7	52358
52825	1629 674	ø40.5	ø50	9	8	52841

Auger Nr.	OEM Nr.	Description	Model	Picture
<b>52358</b>	1075 266 S	Rep. Kit for Cabin ø30xø68x49	FH 12 BR FH 12 FH 12 J FH 16 FH 16 J	
<b>52841</b>	1075 399 S	Rep. Kit for Cabin ø25	FH 12 FH 12 J FH 16 FH 16 J	
<b>54240</b>	1075 335 S	Rep. Kit for Cabin ø29	FH 12 BR FH 12 FH 12 J FH 16 FH 16 J	
<b>54241</b>	2039 0840 S	Rep. Kit for Cabin ø16xø90x70	FH 12 FH 16 FM 10 FM 10 BR FM 12 FM 9 FM 12 BR FM 7	







Auger Nr.	OEM Nr.	Description	Model	Picture
<b>55061</b>	3092 067	Rep. Kit for Cabin Tilt  ø30xø52x17	FL7 FL10 FL12 FM10 BR FM12 BR	
<b>55062</b>	3092 446	Rep. Kit for Cabin Tilt  ø30xø52x20	FH12 FH16	
<b>55063</b>	2099 5564 3090 723	Rep. Kit for Cabin Tilt  ø30.5/ø35.5	FH12 FH16 FM7 FM9 FM10 FM12	
<b>55064</b>	3091 796	Rep. Kit for Cabin Tilt  ø20xø45x81.5	FH12 FH16	
<b>55065</b>	3092 065	Rep. Kit for Cabin Tilt  ø20xø45x47.5	FM7 FM9 FM10 FM12	
<b>55066</b>	3092 066	Rep. Kit for Cabin Tilt  ø35xø53x26	FH12 FH16 FM7 FM9 FM10 FM12	
<b>55067</b>	2048 8307	Rep. Kit for Cabin Tilt  ø40xø53x26	FH12 FH16 FM7 FM9 FM10 FM12 FL7 FL10 FL12	

Auger Nr.	OEM Nr.	Description	Model	Picture
<b>55068</b>	3092 052	Rep. Kit for Cabin Tilt	FH12 FH16 FM7 FM9 FM10 FM12 FL6 FL7 FL10	FL12 
<b>55069</b>	3090 722	Rep. Kit for Cabin Tilt	FH12 FH16	
<b>55070</b>	3092 051	Rep. Kit for Cabin Tilt	FH12 FH16 FM7 FM9 FM10 FM12 FL6 FL7 FL10 FL12	
<b>55071</b>	274 107	Rep. Kit for Cabin Tilt	FL7 FL10	
<b>53075</b>	1697 005	Spherical Bearing ø35xø55x20/25	FL7 FL10 FL12	
<b>20090</b>	1629 722	Shock Absorber for Cabin C/O L. 295 / 430 Connection: O / O	FH 12	
<b>20093</b>	1622 227 3198 849 3986 315	Shock Absorber for Cabin C/O L. 233 / 264 Connection: O / O	FH 12	

Auger Nr.	OEM Nr.	Description	Model	Picture
<b>20091</b>	1622 086	Shock Absorber for Cabin	F 10	
	6794 392		F 12	
	1580 389	C/O L. 186 / 246	F 16	
	1585 586	Connection: O / O		
	1599 459			
	6794 392			
	1622 087			
<b>20092</b>	1076 860	Shock Absorber for Cabin	FH 12	
	3172 986			
	3198 859	Connection: O / O		
<b>20058</b>	3172 984	Cabin Shock Absorber,	FH 12	
	1629 719	With Air Bellow	FH 16	
	1629 724	Monroe Type		
		ø14/ø20xø44.5		
<b>20059</b>	2088 9134	Cabin Shock Absorber,	FH 12	
	2077 5212	With Air Bellow	FH 16	
	2072 1169	Monroe Type		
	2042 7897			
	3172 985			
	1076 855			
			ø14xø45	
<b>20060</b>	1075 076	Cabin Shock Absorber,	FH 12	
	1075 077	With Air Bellow	FH 16	
		Monroe Type		
		ø14xø44.5		
<b>20101</b>	2088 9132	Cabin Shock Absorber,	FH 12	
		With Air Bellow	FH 16	
		Monroe Type		
		ø20xø43.7		
<b>20111</b>	2045 3256	Air Bellow for Cabin	FH 12	
			FH 16	
		ø43.7		

Auger Nr.	OEM Nr.	Description	Model	Picture
<b>51694</b>	3944 648	Cabin Bracket-Left ø25x79/163x144	FH 12 FH 12 J FH 16 FH 16 J	
<b>51695</b>	3944 649	Cabin Bracket-Right ø25x79/163x114	FH 12 FH 12 J FH 16 FH 16 J	
<b>51696</b>	---	Cabin Bushing ø25xø30x28	FH 12 FH 12 J FH 16 FH 16 J	
<b>53117</b>	1075 221	Cabin Bracket-Left ø29x81x169x45	FH 12 BR FH 12 FH 12 J FH 16 FH 16 J	
<b>53118</b>	1075 223	Cabin Bracket-Right ø29x81x169x45	FH 12 BR FH 12 FH 12 J FH 16 FH 16 J	
<b>54211</b>	1076 745	Cabin Bracket-Left ø25/M56x3/150	FH 12 FH 16 FM 10 FM 10 BR FM 12 FM 12 BR FM 7 FM 9	
<b>54212</b>	1076746	Cabin Bracket-Right ø25/M56x3/150	FH 12 FH 16 FM 10 FM 10 BR FM 12 FM 12 BR FM 7 FM 9	
<b>54213</b>	1075 469	Cabin Bracket Plug M56x3/26.5	FM 7 FM 10 FM 12 FM 12 BR	



Auger Nr.	OEM Nr.	Description	Model	Picture	
<b>51732</b>	6799 335	Stabilizer Bushing  ø25.5xø49.5x23.5	FE 6 USA FE 7 USA FL 6 FL 608-615 FL 616-619 FLC FS 7		
<b>51577</b>	1589 807	Stabilizer Bushing  ø25xø35x23	B 7 B 7 F B 7 R F 10 F 12 F 16 FL 10 FL 6 FL 608-615 FL 616-619 FL 7	FL C FS 7 N 10 N 12 NL 10 NL 10 BR NL 10 S NL 12 NL 12 BR NL 12 S	
<b>51578</b>	1587 261	Stabilizer Bushing  ø25xø35x27	F10 F12 F16 FL10 FL12 FL 608-615 FL7 NL10 S NL12 S		
<b>51592</b>	1611 551	Stabilizer Plastic Bearing  ø40x59	F 10 F 12 F 16 FL 10 FL 12 FL 6 FL 616-619 FL 7 FS 7 N 10 N 12 NL 10	NL 10 BR NL 10 S NL 12 NL 12 BR NL 12 S	
<b>51593</b>	1624 611	Stabilizer Plastic Bearing  ø35x59	FH 12 FH 12 J FH 16 FH 16 J		
<b>51594</b>	1605 047	Stabilizer Plastic Bearing  ø61xø75x96	B 10 M F 10 F 12 F 16 FH 12 BR FH 12 J FH 16 FM 10 FM 12 FM 7		







Auger Nr.	OEM Nr.	Description	Model	Picture
<b>51595</b>	1605 182	Stabilizer Plastic Bearing ø55xø73x95	F 10 F 12 F 16 FH 12 BR FH 12 FH 12 J FH 16 FL 10 FL 12 FL 6 FL 7	FM 10 FM 12 FM 7 NH 12 
<b>51596</b>	1607 561	Stabilizer Plastic Bearing ø65xø74x96	F 10 F 12 F 16 FH 12 FH 12 J FH 16 FL 10 FL 12 FL 6 FL 7 NH 12	
<b>51597</b>	9516 579	Stabilizer Plastic Bearing ø61xø75x96	B 10 M B 12 BR B 12	
<b>51603</b>	1622 838	Stabilizer Plastic Bearing ø75xø95x96	F 10 F 12 F 16 FH 12 FH 16 FL 10 FL 12 FL 7	
<b>51600</b>	1628 318	Stabilizer Plastic Bearing ø53xø70x91	FH 12 FH 12 J FH 16 FL 6 FL 616-619 FM 10 FM 12 FM 7 FS 7	
<b>51608</b>	6799 680	Stabilizer Plastic Bearing ø69.5xø90x89	FL 6 FL 608-615 FL 616-619 FS 7	

Auger Nr.	OEM Nr.	Description	Model	Picture
<b>51599</b>	1075 180	Stabilizer Plastic Bearing ø45x66	FH 12 FH 16 FM 10 FM 12 FM 7 FM 9 NH 12 NH 12 BR	
<b>51604</b>	1075 179	Stabilizer Plastic Bearing ø35x67	FH 12 BR FH 12 J FH 16 FH 16 J FM 10 FM 12 FM 7 FM 9 NH 12	
<b>51614</b>	1076 890	Stabilizer Plastic Bearing ø40x66	FH 12 FH 12 BR FH 16 FM 10 FM 10 BR FM 12 FM 12 BR FM 7 FM 9 NH 12 NH 12 BR	
<b>51598</b>	1075 188	Stabilizer Plastic Bearing ø59.5xø74x96	FH 12 FH 16 FM 10 FM 12 FM 7 FM 9	
<b>51602</b>	6772 312 6856 049	Stabilizer Plastic Bearing ø40x56.5	F 6 USA FE 6 USA FE 7 USA FL 6 FL 608-615 FL 616-619 FLC	
<b>51606</b>	6771 515	Stabilizer Plastic Bearing ø45xø60x70.5	B 7 B 7 F FE 6 USA FE 7 USA FL 6 FL 608-615 FL 616-619 FLC FS 7	

Auger Nr.	OEM Nr.	Description	Model	Picture
<b>51611</b>	1589 807 S	Stabilizer Bearing Kit  ø25xø35x23	F 10 F 12 F 16 FL 10 FL 6 FL 616-619 FL 7 N 10 N 12 NL10 BR NL 10 S	NL 12 BR NL 12 S  
<b>51612</b>	1587 261 S	Stabilizer Bearing Kit  ø25xø35x27	F 10 F 12 F 16 FL 10 FL 12 FL 608-615 FL 7 NL 10 S NL 12 S	
<b>53166</b>	1611 551 S	Stabilizer Bearing Kit	F 10 F 12 F 16 FL 10 FL 6 FL 616-619 FL 7 N 10 N 12 NL10 BR NL 10 S NL 12 BR	NL 12 S  
<b>51567</b>	3028 447	Stabilizer Mounting  ø45xø78x96	B 10 M BR	
<b>51568</b>	3028 448	Stabilizer Mounting  ø50xø78x96	B 10 M BR B 12 BR B 58 BR	
<b>51569</b>	3028 449	Stabilizer Mounting  ø55xø78x96	---	

Auger Nr.	OEM Nr.	Description	Model	Picture	
<b>51581</b>	9516 524	Stabilizer Mounting  ø53xø80x95	B 10 B, B 10 BLE B 10 M B 12 BR B 12 B 12 B B 12 M B 6 B 6 BLE FH 12 BR FH 12 FH 16	FM 10 FM 12 FM FM 9 NH 12 NH 12 BR	
<b>51582</b>	9519 245	Stabilizer Mounting  ø59xø90x95	B 10 M BR B 10 M B 10 R BR B 12 BR B 12 B 7 R BR B 7 R FH 12 BR FH 12 FH 16 FL 10	FL 12 FL 7 FM 10 FM 12 FM 7 NH 12 NH 12 BR	
<b>51583</b>	9959 304	Stabilizer Mounting  ø49xø80x95	B 9 S B 7 R B 9 R B 12 B B 12 M B 10 B B 10 M (BR) B 10 M B 12 (BR) B 12 B 12 B B 12 M	B 7 F B 7 R (BR) FL 6 FL 608-615	
<b>51584</b>	7030 1194	Stabilizer Mounting  ø42xø80x95	B 10 B, B 10 BLE B 10 M BR B 12 B B 12 M B 6 B 7 F B 7 L		
<b>51585</b>	1079 256	Stabilizer Mounting  ø65xø116x95	FH 12 BR FH 12 FH 16 FM 10 FM 12 FM 7 FM 9 NH 12 NH 12 BR		
<b>51586</b>	1077 594	Stabilizer Mounting  ø72x116x95	FH 12 FH 16 FM 10 FM 12 FM 7 FM 9 NH 12		

Auger Nr.	OEM Nr.	Description	Model	Picture
<b>55532</b>	3173 991	Stabilizer Mounting ø47xø75x70	FL 6 FM 9 FM 12 FH 12	
<b>54214</b>	2042 8165	Stabilizer Mounting ø30xø61x55	FH 12 FH 16 FM 12 FM 9 NH 12	
<b>54215</b>	2042 8166	Stabilizer Mounting ø35.5xø61x55	FH 12 FH 16 FM 12 FM 9 NH 12	
<b>54216</b>	2042 8167	Stabilizer Mounting ø41.5xø61x55	FE 6 USA FE 7 USA FL 6 FL 608-615	
<b>54217</b>	3173 993	Stabilizer Mounting ø55x74x70	FH 12 FH 16 FM 12 FM 9	
<b>54218</b>	2045 2330	Stabilizer Mounting ø64xø107x65	FM 12 FM 9	
<b>55056</b>	2049 3701	Stabilizer Mounting ø53/ø103.5x78	FH12 FH16 FM9 FM12 FL6 B7R B9R	







Auger Nr.	OEM Nr.	Description	Model	Picture	
<b>55057</b>	1079 225	Stabilizer Mounting  ø58/ø103.5x78	FH12 FH16 FM9 FM12 FL6 B7R B9R		
<b>51613</b>	1628 112	Stabilizer Mounting  ø55x80	FH 12 FH 12 J FH 16 FH 16 J FL 6 FM 10 FM 12 FM 7 FM 9		
<b>51570</b>	1575 339	Stabilizer Bearing  ø49x93.5	F 10 F 12 F 16 FH 12 FH 16 FL 10 FL 12 FL 6 FL 7 FM 10 FM 12	FM 7 FM 9 N 10 NL 10 AUS NL 10 S NL 12 AUS NL 12 S	
<b>51571</b>	1609 768	Stabilizer Bearing  ø53x75	F10 F12 F16 FL10 FL12 FL7 NL10 S NL12 S		
<b>51572</b>	1573 032	Stabilizer Bearing  ø50x75	F 10 F 12		
<b>51573</b>	1629 169	Stabilizer Bearing  ø60x94	FH 12 BR FH 12 FH 16 FH 16 J FL 6 FM 10 FM 10 BR FM 12 FM 12 BR FM 7 FM 9	NH 12 NH 12 BR NH 12	
<b>51574</b>	363 864	Stabilizer Bearing  ø45x75	B58 F10 F12 B7 N10 N12		

Auger Nr.	OEM Nr.	Description	Model	Picture
<b>51575</b>	1580 010	Stabilizer Bearing  ø49xø90x86	F 10 F 12 F 16 FL 10 FL 12 FL 12 FL 608-615 FL 7 NL 10 AUS NL 10 BR	NL 10 S NL 12 AUS NL 12 BR NL 12 S 
<b>51576</b>	1580 009	Stabilizer Bearing  ø30xø66x75	F 10 F 12 F 16 FL 10 FL 12 FL 608-615 FL 7 NL 10 AUS NL 10 BR	NL 10 S NL 12 AUS NL 12 BR NL 12 S 
<b>51607</b>	6875 470	Stabilizer Bearing  ø43xø61x69	B 7 B 7 F FE 6 USA FE 7 USA FL 608-615	
<b>51588</b>	1134 955	Stabilizer Rubber Bushing  ø28x57.5x64	B 10 B, B10 BLE B 10 M BR B 10 M B 10 R BR B 12 BR B 12 B 58 BR B 6 B 7 B 7 F B 7R BR B 7R F 10 F 12 F 16 FH 12 BR FH 12 J FH 16	FH 16 J FL 10 FL 12 FL 6 FL 608-615 FL 616-619 FL 7 FM 10 FM 12 FM 7 FM 9 FS 7 NH 12 NL 10 AUS NL 10 S NL 12 AUS NL 12 S 
<b>51589</b>	1620 750	Stabilizer Rubber Bushing  ø34xø65.5x64	B 7 R B 7 R BR F 10 F 12 F 16 FH 12 FH 12 BR FH 12 J FH 16 FL 10	FL 12 FL 6 FL 616-619 FL 7 FM 10 FM 12 FM 7 FM 9 NH 12 NH12 BR 
<b>51601</b>	1624 605	Stabilizer Rubber Bushing  ø17.5xø45x50	FH 12 BR FH 12 J FH 16 FH 16 J FL 10 FL 12 FL 7	FM 10 FM 12 FM 7 FM 9 NH 12 
<b>51633</b>	363 862	Stabilizer Rubber Bushing  ø16xø40x120	B 58 BR F 10 F 12 F 16 FL 10 FL 12 FL 7 N 10 N 12	NL 10 S 



Auger Nr.	OEM Nr.	Description	Model	Picture	
<b>51559</b>	8152 450	Stabilizer Bolt  ø14.5x107/ø34x140	B 7 R BR B 7 R F 12 F 16 FH 12 BR FH 12 FH 12 J FH 16 FL 10 FL 12 FL 6	FL 616-619 FM 10 FM 12 FM 7 FM 9 NH 12 NH 12 BR	
<b>51560</b>	1620 753	Stabilizer Bolt  ø14x97/ø34x127	F 10 F 12 F 16 FH 12 FH 16 FL 10 FL 7 FM 10 FM 12 FM 7		
<b>51561</b>	3030 255	Stabilizer Bolt  ø15x97/ø28x122	B 10 B, B10 BLE B 10 M B 12 (BR) B 12 B 12 M B 6 B 7 B 7F B 7R FL 6 FL 608-615 FL 616-619	FS 7	
<b>51562</b>	1608 758	Stabilizer Bolt  ø13.5x97/ø28x122	B 10 B, B10 BLE B 10 M BR B 10 M B 10 R BR B 12 BR B 12 F 10 F 12 F 16 FL 10 FL 12	FL 7	
<b>51563</b>	1135 803	Stabilizer Bolt  ø12x97/ø28x122	B 10 M BR B 10 M B 10 R B 12 BR B 58 BR B 7 B 7 R		
<b>51564</b>	8157 254	Stabilizer Bolt  ø14.5x107/ø28x140	F 10 F 12 F 16 FL 10 FL 12 FL 7		







Auger Nr.	OEM Nr.	Description	Model	Picture		
<b>51579</b>	1588 445	Metal Bushing for Stabilizer  ø17xø25x52	F 10 F 12 F 16 FL 10 FL 12 FL 6 FL 608-615 FL 7 NL 10 S NL 12 S			
<b>51580</b>	1625 954	Metal Bushing for Stabilizer  ø17xø25x45	B 6 B 7 B 7F B 7R F 10 F 12 F 16 FL 10 FL 6 FL 608-615 FL 616-619 FL 7	FS 7 N 10 N 12 NL 10 AUS NL 10 S NL 12 AUS NL 12 BR NL 12 S NL10 BR		
<b>51591</b>	1135 085	Metal Bushing for Stabilizer  ø16xø28x25	B 10 M BR B 10 M B 10 R BR B 12 BR B 12 B 7 B 7F B 7R BR F 10 F 12 F 16 FH 12 BR	FH 12 FH 12 J FH 16 FH 16 J FL 10 FL 12 FL 6 FL 616-619 FL 7 FM 10 FM 10 BR	FM 12 FM 12 BR FM 7 FM 9 FS 7 NH 12 BR NH 12 NL 10 AUS NL 10 S NL 12 AUS NL 12 S	
<b>51590</b>	1135 086	Nut for Stabilizer  M16/27.5x25	F 10 F 12 F 16 FH 12 FH 12 J FH 16 FL 10 FL 12 FL 6 FL 616-619 FL 7	FS 7 NL 10 AUS NL 10 S NL 12 AUS		
<b>52706</b>	192 283	Washer  ø16.5xø43.5x4	F 10 F 12 F 16 FL 6 FL 7 F 40 FL 12 B 58	F 57 FL 608-615		

Auger Nr.	OEM Nr.	Description	Model	Picture
<b>53138</b>	348 979 S	Rep. Kit for Brake Shoe	F 10 F 12 F 7 USA N 10 N 10 USA N 12 N 12 USA NL 10 BR NL 12 BR	
<b>53139</b>	348 979 S1	Rep. Kit for Brake Shoe	F 10 F 12 F 7 USA N 10 N 10 USA N 12 N 12 USA NL 10 BR NL 12 BR	
<b>53140</b>	341 717 S	Rep. Kit for Brake Shoe	F 10 F 12 F 7 USA N 10 N 10 USA N 12 N 12 USA NL 10 BR NL 12 BR	
<b>53123</b>	1584 671	Brake Shoe Pin  ø25x55.5	B 10 B, B10 BLE B 10 L B 10 M BR B 10 M B 10 R BR B12 BR B 12 B 12 M B 58 BR B 7 B 7 F B7 L	
<b>53124</b>	1584 673	Brake Shoe Pin  ø18xø30x86	F 10 F 12 F 7 USA N 10 N 10 USA N 12 N 12 USA NL 10 BR NL 12 BR	
<b>53127</b>	1586 716 1584 672	Brake Shoe Pin  ø17.5xø30x116	B 10 B, B 10 BLE B 10 L B 10 M BR B 10 M B 10 R BR B 12 BR B 12 B 12M B 58 BR B 7 B 7 F B 7 L B 7 L DD	

Auger Nr.	OEM Nr.	Description	Model	Picture		
<b>53122</b>	348 979	Brake Shoe Roller  ø25xø48x32	F 10 F 12 F 7 N 10 N 10 USA N 12 N 12 USA NL 10 BR NL 12 BR			
<b>53130</b>	341 717	Brake Shoe Roller  ø25xø48x32.5	B 10 B, B 10 BLE B 10 L B 10 M B 10 M BR B 10 R BR B 12 B 12 BR B 12 M B 58 BR B 7 B 7 F	B 7 L B 7 L DD B 7 R B 7 R BR		
<b>53126</b>	1586 683 341 720	Brake Shoe Spring  ø36.5x204	B 10 B, B 10 BLE B 10 L B 10 M BR B 10 M B 10 R BR B 12 BR B 12 B 12 M B 58 BR B 7	B 7 F B 7 L B7L DD B 7 R BR B 7 R F 10 F 12 F 7 USA N 10 N 10 USA N 12	N 12 USA NL 10 BR NL 12 BR	
<b>53129</b>	346 499	Brake Shoe Spring  ø46x201	B 10 B, B 10 BLE B 10 M BR B 10 M B 10 R BR B 12 BR B 12 B 58 BR B 7 B 7 F B 7R BR B 7 R F 10	F 12 N 10 N 12 NL 10 BR NL 12 BR		
<b>53487</b>	1695 051	Brake Shoe Spring  ø24x216	FL 6 FL 616-619			
<b>51711</b>	3097 092 1696 444	Return Spring  73x295	B 10 B, B 10 BLE B 10 L B 12 B 12 BR F 10 F 12 F 16 FH 12 FH 12 BR FH 12 J FH 16	FH 16 J FL 10 FL 12 FL 6 FL 616-619 FM 7 FM 10 FM 10 BR FM 12 FM 12 BR FM 7	FM 9 NH 12 NH 12 BR NL 10 AUS NL 10 S NL 12 AUS NL 12 S OLYMPIA N MKII SUPER OLYMPIA N	

Auger Nr.	OEM Nr.	Description	Model	Picture	
<b>53296</b>	1606 683	Brake Camshaft Bushing  ø44xø49x30	B 10 B, B 10 BLE B 10 L B 10 M BR B 10 M B 10 R BR B12 BR B 12 B 12 M B 58 BR B 7 B 7 F B 7 L	B 7 L DD B 7 R BR B 7 R F 10 F 12 F 7 USA N 10 N 10 USA N 12 N 12 USA NL 10 BR NL 12 BR	
<b>53125</b>	1606 679 348 977	Brake Shoe Bushing  ø30xø34x18	F 10 F 12 F 7 USA N 10 N 10 USA N 12 N 12 USA NL 10 BR NL 12 BR		
<b>53128</b>	1606 681 348 978	Brake Shoe Bushing  ø30xø34x24	B 10 B, B 10 BLE B 10 L B 10 M BR B 10 M B 10 R BR B 12 BR B 12 B 12 M B 58 BR B 7 B 7 F B 7 L	B 7 L DD B 7 R BR B 7 R F 10 F 12 F 7 USA N 10 N 10 USA N 12 N 12 USA NL 10 BR NL 12 BR	
<b>53131</b>	341 719	Brake Shoe Bushing  ø25xø28x28	B 10 B, B 10 BLE B 10 L B 10 M BR B 10 M B 10 R BR B 12 BR B 12 B 12 M B 58 BR B 7 B 7 F	B 7 L B 7 L DD B 7 R BR B 7 R	
<b>55198</b>	1088 812	Bushing for Brake Adjuster  ø38.4xø43x26	F10 F12 F16 FM9 FM10 FM12 FL6 FL7 FL10 FL12 FH12	FH16 NL10 NL12 B12 NH12	
<b>55208</b>	1696 446	Pin for Brake Adjuster  ø12.6x59	F10 FM9 FM12 FH12 FH16 NL10 NL12 NH12		

Auger Nr.	OEM Nr.	Description	Model	Picture
<b>54274</b>	272 857	Brake Adjuster Rep. Kit	FL 6 FL 616-619	
<b>55218</b>	8550 978 3097 099 272 909 3098 276	Brake Adjuster Rep. Kit, Left  ø55x112	FH 12 FH 16 FM 12 FM 9 NH 12 FL 6 FM 12 BR NL10 S NL12 S F 10 OLYMPIAN SUPER	OLYMPIAN B 12  
<b>55219</b>	8550 977 3097 100 272 908	Brake Adjuster Rep. Kit, Right  ø55x112	FH 12 FH 16 FM 12 FM 9 NH 12 FL 6 FM 12 BR NL10 S NL12 S F 10	
<b>55222</b>	276 097	Brake Adjuster Rep. Kit	FH 12 FH 16 FM 12 FM 9 NH 12 F 10 F 12 FL 6	
<b>55223</b>	272 904	Brake Adjuster Rep. Kit	FH 12 FH 16 FM 12 FM 9 NH 12 FL 6 FM 12 BR F 10 NL10 S NL12 S	
<b>55072</b>	271 259	Rep. Kit for Brake Shoe	FL608 FL615 B6	

Auger Nr.	OEM Nr.	Description	Model	Picture	
<b>53961</b>	3090 954 1696 448	Dust Cover  ø36xø63x19	B 10 B, B 10 BLE B 10 L B 12 B 12 BR F 10 F 12 F 16 FH 12 FH 12 BR FH 12 J FH 16	FH 16 J FL 10 FL 12 FL 616- 619 FL 7 FL 6 FM 10 FM 10 BR FM 12 FM 12 BR FM 7 FM 9 NH 12 NH 12 BR NL10 AUS NL10 S NL12 AUS NL12 S OLYMPIA N MKII SUPER- OLYMPIA N	
<b>52823</b>	1629 836	Dust Cover Phosphated & Painted  ø234xø446x79	B 10 B, B 10 BLE B 10 L B 12 B 12 BR F 10 F 12 F 16 FH 12 FH 16 FL 10 FL 12 FL 6	FL 7 FM 10 FM 12 FM 7 FM 9 NH 12 NL 10 S NL 12 S	
<b>52824</b>	1629 835	Dust Cover Phosphated & Painted  ø234xø446x66	B 10 B, B 10 BLE B 12 B 12 BR F 10 F 12 F 16 FH 12 FH 12 BR FH 12 J FH 16 FH 16 J	FL 10 FL 12 FL 6 FL 7 FM 10 FM 10 BR FM 12 FM 12 BR FM 7 FM 9 NH 12 NH 12 BR NL 10 AUS NL 10 S NL 12 AUS NL 12 S	
<b>53119</b>	1629 832	Dust Cover Phosphated & Painted  ø234xø446x29	B 12 BR B 12 F 10 F 12 F 16 FH 12 FH 16 FL 10 FL 12 FL 6 FL 616-619	FL 7 FM 10 FM 12 FM 7 FM 9 NL 10 S	
<b>53120</b>	1629 833	Dust Cover Phosphated & Painted  ø234xø446x42	F 10 F 12 F 16 FH 12 FH 12 J FH 16 FH 16 J FL 10 FL 12 FL 6 FL 7 FM 10	FM 12 FM 7 FM 9 NH 12 NL 10 AUS NL 10 S NL 12 AUS NL 12 S	
<b>53121</b>	1629 834 2036 7343	Dust Cover Phosphated & Painted  ø234xø446x54	F 10 F 12 F 16 FH 12 FH 12 BR FH 12 J FH 16 FH 16 J FL 10 FL 12 FL 6 FL 7 FM 10	FM 10 BR FM 12 FM 12 BR FM 7 FM 9 NH 12 NH 12 BR NL 10 AUS NL 10 S NL 12 S OLYMPIAN MKII SUPER- OLYMPIAN	

**Diaphragms - Normal Stroke**





<b>Auger Nr.: 52576</b>	
O.E.M. Nr. 353 314	
Type	9"
<b>Auger Nr.: 52578</b>	
O.E.M. Nr. 325 197	
Type	12"
<b>Auger Nr.: 52580</b>	
O.E.M. Nr. 1614 796 - 1609 308 - 325 867	
Type	16"
<b>Auger Nr.: 52581</b>	
O.E.M. Nr. 1614 797 - 1609 309 - 338 458	
Type	20"
<b>Auger Nr.: 52582</b>	
O.E.M. Nr. 1614 798 - 1609 310 - 338 452	
Type	24"
<b>Auger Nr.: 52583</b>	
O.E.M. Nr. 1614 799 - 1609 311 - 1588 818	
Type	30"
<b>Auger Nr.: 52584</b>	
O.E.M. Nr. 1518 741	
Type	36"

**Diaphragms - Long Stroke**

<b>Auger Nr.: 52585</b>	
O.E.M. Nr. 3090 848	
Type	16"
<b>Auger Nr.: 52586</b>	
O.E.M. Nr. —	
Type	20"
<b>Auger Nr.: 52587</b>	
O.E.M. Nr. 1698 126	
Type	24"
<b>Auger Nr.: 52588</b>	
O.E.M. Nr. —	
Type	30"





Auger Nr.	OEM Nr.	Description	Model	Picture
<b>21012</b>	---	Service Brake Chamber (for Drum Brake)  113/126xM16x1.5	---	
<b>21013</b>	526031200000	Service Brake Chamber (for Drum Brake)  113/126xM16x1.5	---	
<b>21014</b>	---	Service Brake Chamber (for Drum Brake)  112,5/126xM16x1.5	---	
<b>21015</b>	6212 188	Service Brake Chamber (for Drum Brake)  112,5/126xM16x1.5	---	
<b>53871</b>	3092 264	Rep. Kit for Brake Caliper  Ror Type	FH 12 FH 16 FM 7 FM 9 FM 12 B 12	









Auger Nr.	OEM Number	Dia.	Capacity	Description
<b>21948</b>	20904408	ø276	30 L	-
<b>21949</b>	20904411	ø276	40 L	562; 09, FE; TB-106846412-2
<b>21905</b>	11117328	ø276	40 L	-









Auger Nr.	O.E.M. Nr.	A	B	C	Type	Repair Kit
54179	1599 575	ø50.2	ø55.2	48.5	1	52609- 54230- 54231- 54232
54786	1599 574	ø48.2	ø53.2	48.5	1	52610- 54233- 54234- 54235
54787	6774 853	ø45.3	ø50.3	44.5	1	52567- 54236- 54237- 54238
54788	3173 775	ø60	ø65	50.5	1	54239- 54672-55500
54608	---	ø47.5	ø53	50.5	2	52610- 54233- 54234- 54235
54902	365 345	ø45	ø50	50	2	52566- 54227- 54228- 54229
54599	6889 595	ø44.5	ø95.25	31	3	54228- 54229- 54234- 54235
54600	6782 631	ø40	ø90	25.25	3	54237- 54238
54824	1588 222	ø38.1	ø90	35.25	3	54231- 54232
54828	3173 772	ø40	ø90	39	3	54672









Auger Nr.	O.E.M. Nr.	A	B	C	Type	Repair Kit
54848	192 226	ø51	ø68	6	1	52566- 54227- 54228- 54229 52610- 54233- 54234- 54235
54849	1586 009	ø50	ø62	5	1	52609- 54230- 54231- 54232
54887	1078 240	ø48	ø73	11.5	1	54239- 54672-55500
54850	192 206	ø44.5	ø77	7	2	52566- 54227- 54228- 54229
54851	947 285	ø47.5	ø75.5	8	2	52610- 54233- 54234- 54235
54888	3173 774	ø50	ø72	8.5	2	54239- 54672-55500
54859	1580 269	ø49.5	ø75	9.7	3	52609- 54230- 54231- 54232
54866	6879 860	ø44.5	ø64.5	8	3	52567- 54236- 54237- 54238

Auger Nr.	OEM Nr.	Description	Model	Picture	
<b>52566</b>	276 029 276 014	King Pin Set, Without Bearing Single  ø34/ø45x237	B 57 / B 58 B 59 B 715 / B 755 F 86 / FB 86 FA 6,0 F 88 / FB 88 / G 88 F 89 / G 89 N 7 N 10 N 12		
<b>54227</b>	276 029 S 276 014 S	King Pin Set, Without Bearing Double  ø34/ø45x237	B 57 / B 58 B 59 B 715 / B 755 F 86 / FB 86 FA 6,0 F 88 / FB 88 / G 88 F 89 / G 89 N 7 N 10 N 12		
<b>54228</b>	276 029 S1 276 014 S1	King Pin Set, With Bearing Single  ø34/ø45x237	B 57 / B 58 B 59 B 715 / B 755 F 86 / FB 86 FA 6,0 F 88 / FB 88 / G 88 F 89 / G 89 N 7 N 10 N 12		
<b>54229</b>	276 029 S2 276 014 S2	King Pin Set, With Bearing Double  ø34/ø45x237	B 57 / B 58 B 59 B 715 / B 755 F 86 / FB 86 FA 6,0 F 88 / FB 88 / G 88 F 89 / G 89 N 7 N 10 N 12		
<b>52609</b>	3090 266 271 142 276 031 270 912 276 023	King Pin Set, Without Bearing Single  M36xø38/ø50x251	B 10 B, B 10 BLE B 10 L B 10 M B 12 BR B 12 B 12 B B 7 L B 7 L DD B 7 R F 10 F 10 F 12 F 16 F 7 USA FH 12 BR FH 12 FH 12 J FH 16 FH 16 J FL 10 FL 12 FL 6 FL 616-619 FL 7 FM 10 FM 10 BR	FM 12 FM 12 BR FM 7 FS 7 N 10 N 10 USA N 12 N 12 USA NH 12 NH 12 BR NH 12 NL 10 AUS NL 10 BR NL 10 S NL 12 AUS NL 12 BR NL 12 S OLYMPIAN MKII SUPER-OLYMPIAN	
<b>54230</b>	3090 266 S 271 142 S 276 031 S 270 912 S 276 023 S	King Pin Set, Without Bearing Double  M36xø38/ø50x251	B 10 B, B 10 BLE B 10 L B 10 M B 12 BR B 12 B 12 B B 7 L B 7 L DD B 7 R F 10 F 10 F 12 F 16 F 7 USA FH 12 BR FH 12 FH 12 J FH 16 FH 16 J FL 10 FL 12 FL 6 FL 616-619 FL 7 FM 10 FM 10 BR	FM 12 FM 12 BR FM 7 FS 7 N 10 N 10 USA N 12 N 12 USA NH 12 NH 12 BR NH 12 NL 10 AUS NL 10 BR NL 10 S NL 12 AUS NL 12 BR NL 12 S OLYMPIAN MKII SUPER-OLYMPIAN	

Auger Nr.	OEM Nr.	Description	Model	Picture
<b>54231</b>	3090 266 S1	King Pin Set, With Bearing Single	B 10 B, B 10 BLE	
	271 142 S1		B 10 L	
	276 031 S1	B 10 M		
	270 912 S1	B 12 BR		
	276 023 S1	B 12		
	276 023 S1	B 12 B		
<b>54232</b>	3090 266 S2	King Pin Set, With Bearing Double	B 7 L	
	271 142 S2		B 7 L DD	
	276 031 S2	B 7 R		
	270 912 S2	F 10		
	276 023 S2	F 10		
		F 12		
		F 16		
		F 7 USA		
		FH 12 BR		
		FH 12		
		FH 12 J		
		FH 16		
		FH 16 J		
		FL 10		
	FL 12			
	FL 6			
	FL 616-619			
	FL 7			
	FM 10			
	FM 10 BR			
<b>52610</b>	3090 267	King Pin Set, Without Bearing Single	B 10 M BR	
	270 911		B 10 R BR	
	271 141	B 12 BR		
		B 58 BR		
		B 7		
		B 7 F		
		B 7 R BR		
		B 7 R		
		F 10		
		F 12		
		F 16		
		F 7 USA		
		FE 6 USA		
		FL 10		
	FL 12			
	FL 6			
	FL 616-619			
	FL 7			
	FS 7			
	N 10			
	N 10 USA			
	N 12			
	N 12 USA			
	NL 10 AUS			
	NL 10 BR			
	NL 10 S			
	NL 12 AUS			
	NL 12 BR			
	NL 12 S			
<b>54233</b>	3090 267 S	King Pin Set, Without Bearing Double	B 10 M BR	
	270 911 S		B 10 R BR	
	271 141 S	B 12 BR		
		B 58 BR		
		B 7		
		B 7 F		
<b>54234</b>	3090 267 S1	King Pin Set, With Bearing Single	B 7 R BR	
	270 911 S1		B 7 R	
	271 141 S1	F 10		
		F 12		
		F 16		
		F 7 USA		
		FE 6 USA		
		FL 10		
		FL 12		
		FL 6		
		FL 616-619		
		FL 7		
		FS 7		
		N 10		
	N 10 USA			
	N 12			
	N 12 USA			
	NL 10 AUS			
	NL 10 BR			
	NL 10 S			
	NL 12 AUS			
	NL 12 BR			
	NL 12 S			
<b>54235</b>	3090 267 S2	King Pin Set, With Bearing Double	B 10 M BR	
	270 911 S2		B 10 R BR	
	271 141 S2	B 12 BR		
		B 58 BR		
		B 7		
		B 7 F		

Auger Nr.	OEM Nr.	Description	Model	Picture
<b>52567</b>	276 193	King Pin Set, Without Bearing Single  M30xø35/ø45x221	B 6 B 6 BLE FE 6 USA FE 7 USA FL 6 FL 608-615	
<b>54236</b>	276 193 S	King Pin Set, Without Bearing Double  M30xø35/ø45x221	B 6 B 6 BLE FE 6 USA FE 7 USA FL 6 FL 608-615	
<b>54237</b>	276 193 S1	King Pin Set, With Bearing Single  M30xø35/ø45x221	B 6 B 6 BLE FE 6 USA FE 7 USA FL 6 FL 608-615	
<b>54238</b>	276 193 S2	King Pin Set, With Bearing Double  M30xø35/ø45x221	B 6 B 6 BLE FE 6 USA FE 7 USA FL 6 FL 608-615	
<b>54239</b>	3093 731	King Pin Set  M40x1.5/ø60x232	B 12 B 12 B B 12 M B 7 B 7 L B 7 L DD B 7 R B 9 B 9 S FH 12 FH 16 FL 6	
<b>54672</b>	2059 0486 S	King Pin Set  M40x1.5/ø60x226	FE TA-HYDRS TB-98822767-1	

Auger Nr.	OEM Nr.	Description	Model	Picture
<b>55500</b>	8510 8338	King Pin Set  M40xø40/ø60x227	FL 6	
			NH 12	
			FM 7	
			FM 12	
			FM 10	
			FM 9	
			FH 12	
FH 16				
<b>53959</b>	3985 590 1625 712 3963 419	Hub Cap  M115x2/62xSW115	FL 10	
			B 10 B,	
			B 10 BLE	
			B 10 L	
			B 10 M	
			B 12	
			B 12 B	
			B 7	
			B 7 F	
			B 7 L	
			B 7 L DD	
			B 7 R	
			F 10	
			F 12	
			F 16	
			F 7 USA	
			FE 7 USA	
FH 12				
FH 12 BR				
FH 12 J				
FH 16				
FH 16 J				
FL 10				
FL 12				
FL 6				
FL 616-619				
FL 7				
FM 10				
FM 10 BR				
FM 12				
FM 12 BR				
FM 7				
FM 9				
FS 7				
N 10 USA				
N 12 USA				
NH 12				
NH 12				
NH 12 BR				
NL 10 AUS				
NL 10 S				
NL 12 AUS				
NL 12 S				
OLYMPIAN				
MKII				
SUPER-OLYMPIAN				
OLYMPIAN				
<b>53960</b>	2039 0132	Hub Cap Plug  M30x2/27	B 10 B, B 10	
			BLE	
			B 10 L	
			B 10 M	
			B 12	
			B 12 B	
			B 7	
			B 7 F	
			B 7 L	
			B 7 L DD	
			B 7 R	
			F 10	
			F 12	
			F 16	
			FH 12 BR	
			FH 12	
			FH 12 J	
FH 16				
FH 16 J				
FL 10				
FL 12				
FL 6				
FL 616-619				
FL 7				
FM 10				
FM 10 BR				
FM 12				
FM 12 BR				
FM 7				
FM 9				
FS 7				
NH 12				
NH 12 BR				
NH 12				
NL 10 AUS				
NL 10 S				
NL 12 AUS				
NL 12 S				
OLYMPIAN				
MKII				
SUPER-OLYMPIAN				
OLYMPIAN				
<b>52821</b>	1591 023	Bearing Half for Axle  99.5x220x110	F 10	
			F 12	
			F 16	
			FH 12	
			FH 16	
			FL 10	
			FL 12	
			FL 6	
			FL 7	
			FM 10	
			FM 12	
FM 7				
FM 9				
FM 9				
NL 10 S				
NL 12 S				
<b>52830</b>	1628 217	Bearing Half for Axle  124x334x115	FH 12	
			FH 16	
			FL 6	
			FM 10	
			FM 12	
			FM 7	
			FM 9	
<b>54219</b>	2039 9428	Cap for Steering Knuckle  M93x3/ø106x31	B 12 B	
			B 12 M	
			B 7 L	
			B 7 L DD	
			B 7 R	
			B 9 R	
			B 9 S	
			FH 12	
			FH 16	
			FL 6	
			FM 10	
FM 12				
FM 7				
FM 9				
NH 12				

Auger Nr.	OEM Nr.	Description	Model	Picture		
<b>54648</b>	1078 564	Cap for Steering Knuckle ø86x20	FM 9 FM 10 FM 12 NH 12 FL 6 B 7 B 9 B 12 FH 12 FH 16			
<b>53956</b>	191 178	Axle Nut ø80.5 W12G / 13 x SW105	B 10 B B 10 BLE B 10 L B 10 M B 10 R BR B 12 B 58 BR B 7 B 7 F B 7 L B 7 L DD B 7 R B 7 R BR B 10 M BR B 12 BR F 10 F 12	F 16 F 7 USA FE 6 USA FE 7 USA FH 12 FH 12J FH 16 FL 10 FL 12 FL 6 FL 616-619 FL 7 FM 10 FM 12 FM 7 FM 9 FS 7	N 10 N 10 USA N 12 N 12 USA NH 12 NL 10 AUS NL 10 BR NL 10 S NL 12 AUS NL 12 BR NL 12 S OLYMPIAN MKII SUPER- OLYMPIAN	
<b>53957</b>	324 665	Axle Nut ø80.5 W12G / 13 x SW105	B 10 B B10BLE B 10 L B 10 M BR B 10 M B 10 R BR B 12 BR B 12 B 58 BR B 7 B 7 L B 7 L DD B 7 R BR B 7 R	F 10 F 12 F 16 F 7 USA FH 12 FH 12 J FH 16 FL 10 FL 6 FL 616-619 FL 7 FS 7 N 10		
<b>53958</b>	1522 384	Axle Nut M80 x 2 / 17 x SW95	B 10 M BR F 10 F 12 F 16 FH 12 BR FH 12 FH 16 FH 16 J FL 10 FL 12 FL 7 FM 10 FM 10 BR FM 12	FM 12 BR FM 7 FM 9 N 10 NH 12 NH 12 BR NH 12 NL 10 AUS NL 10 BR NL 10 S NL 12 AUS NL 12 BR NL 12 S		
<b>51709</b>	1575 525	Lock Washer ø50xø84.5x2	B 10 M BR B 58 BR F 10 F 10 F 12 F 7 USA FL 10 FL 7 N 10 N10 USA N 12	N12 USA		
<b>51710</b>	191 179	Lock Washer ø83xø121x3	B 10B, B10 BLE B 10 L B 10 M BR B 10 R BR B 12 BR B 58 BR B 7 B 7 F B 7 L B 7 L DD B 7R BR B 7R F 10 F 12	F 16 F 7 USA FE 6 USA FE 7 USA FH 12 FH 12 J FH 16 FL 10 FL 12 FL 6 FL 616-619 FL 7 FS 7 N 10 N 10 USA	N 12 N 12 USA NH 12 NL 10 AUS NL 10 BR NL 10 S NL 12 AUS NL 12 BR NL 12 S OLYMPIAN MKII SUPER- OLYMPIAN	

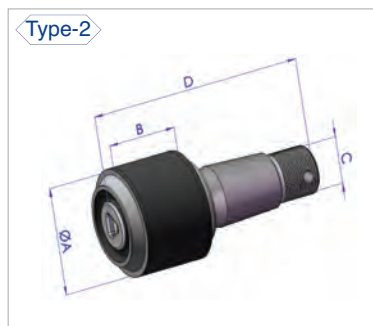
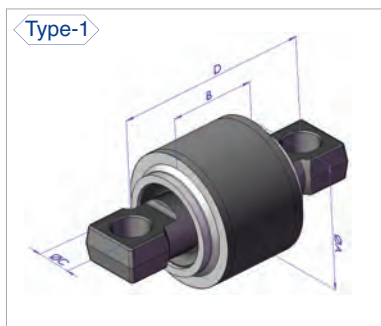

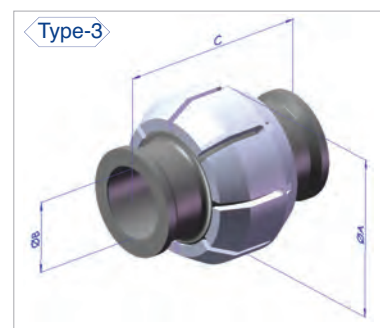
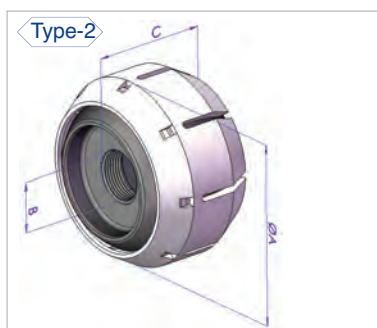
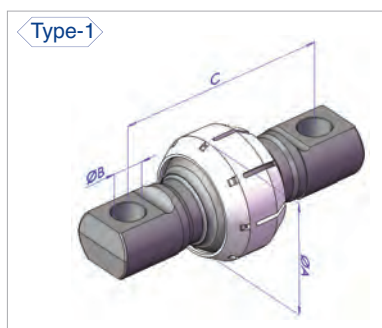

Auger Nr.	O.E.M. Nr.	A	B	C	D	Type
51134	274 068	ø85	54	ø21	152	1
51400	275 988	ø67	43	ø17	100	1
51444	274 019 - 273 373	ø85	54	ø21	130	1
51619	274 056 - 276 192	ø95	61	ø23	152	1
51972	274 070	ø75	48	ø21	130	1
54189	273 612	ø95	61	ø21	130	1
51445	271 187	ø75	48	ø17	115	1
53944	3093 462	ø75	52	ø17	115	1
54571	3198 309	ø108	82.5	ø25	152	1
54573	3093 630 - 3093 631	ø85	54	21/26	130	1
54574	3092 452	ø75	52	17/20	115	1
55119	2054 7286	ø75	52	ø19	115	1
54637	3097 188	ø85	54	M36x1.5	248	2









Auger Nr.	O.E.M. Nr.	A	B	C	Type
51449	273 375	ø90	ø23	152	1
51450	273 706 - 276 191	ø90	M24x1.5	59	2
51451	271 188	ø72	M20x1.5	46	2
51622	273 374	ø90	M24x1.5	60	2
51623	274 069	ø72	M20x1.5	46	2
51624	3090 712	ø90	M14x1.5	60	2
53201	3133 173	ø72	M20x1.5	46	2
54575	2074 1710 - 3093 544	ø72	M20x1.5	46	2
53010	309 0015	ø46	ø20	60	3





Auger Nr.	OEM Nr.	Description	Model	Picture	
<b>51134</b>	274 068	Rep. Kit for Axle Rod  ø85xø21/152	F 10 F 12 F 16 FL 10 FL 12 FL 7 N 10 USA N 12 USA NL 10 AUS NL 10 S NL 12 AUS		
<b>51400</b>	275 988	Rep. Kit for Axle Rod  ø67xø17/100	B 6 B 6 BLE B 7 L B 7 L DD F 10 F 12 F 16 FH 12 FH 12 BR FH 16 FL 10 FL 12 FL 6	FL 7 FM 10 FM 10 BR FM 12 FM 12 BR FM 7 FM 9 NH 12 NH 12 NH 12 BR NL 10 AUS NL 12 AUS	
<b>51444</b>	274 019 273 373	Rep. Kit for Axle Rod  ø85xø21/130	B10 B, B 10 BLE F 10 F 12 F 16 FH 12 FH 12 BR FH 16 FH 16 J FL 10 FL 12 FL 7 FM 10 FM 10 BR FM 12 FM 12 BR	FM 7 FM 9 N 10 N 10 USA N 12 N 12 USA NH 12 NH 12 BR NL 10 AUS NL 10 BR NL 10 S NL 12 AUS NL 12 BR NL 12 S	
<b>51445</b>	271 187	Rep. Kit for Axle Rod  ø75xø17/115	F 10 F 12 F 16 FH 12 FH 12 BR FH 16 FL 10 FL 12 FL 6 FL 7 FM 10	FM 10 BR FM 12 FM 12 BR FM 7 FM 9 N 10 USA N 12 USA NH 12 NH 12 BR NL 10 AUS NL 12 AUS	
<b>51619</b>	274 056 276 192	Rep. Kit for Axle Rod  ø95xø23/152	F 10 F 12 F 16 FL 10 FL 12 N 10 N 10 USA N 12 N 12 USA NL 10 BR NL 12 BR		
<b>51972</b>	274 070	Rep. Kit for Axle Rod  ø75xø21/130	F 10 F 12 F 16 FL 10 FL 12 FL 7 N 10 USA N 12 USA NL 10 AUS NL 10 S NL 12 AUS	NL 12 S  	
<b>53944</b>	3093 462	Rep. Kit for Axle Rod  ø75xø17/115	FH12 FH16 FM7 FM9 FM10 FM12 FL6 B7L		









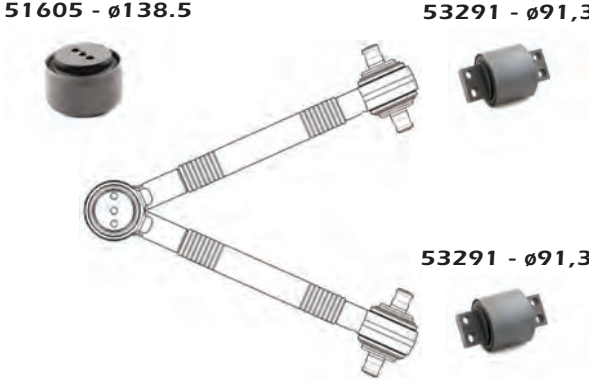
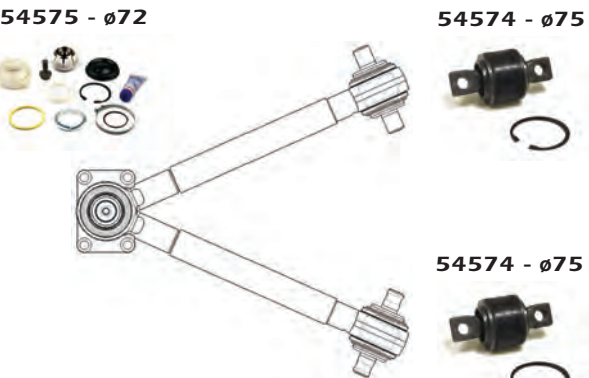
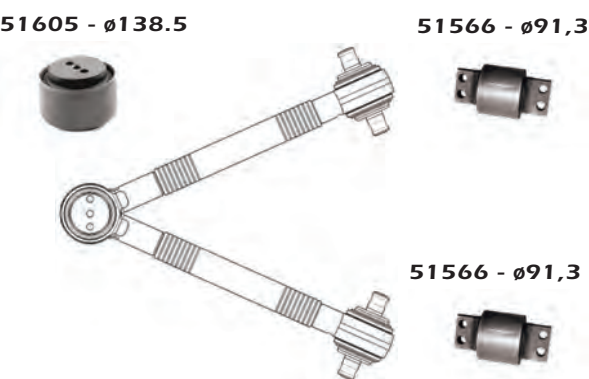
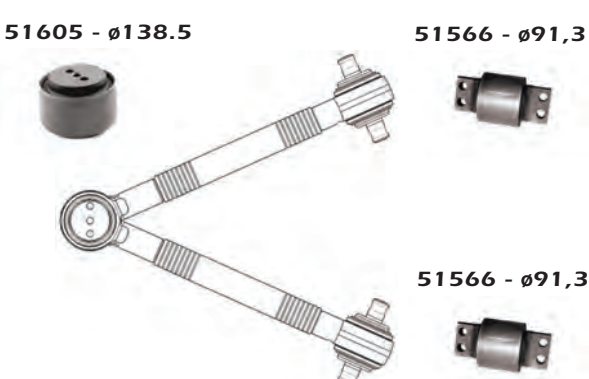

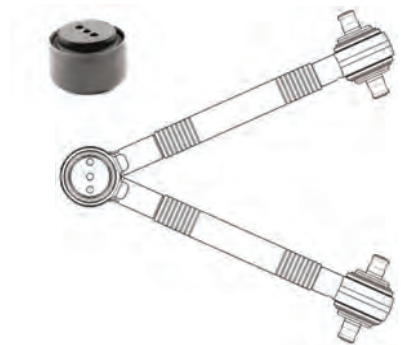

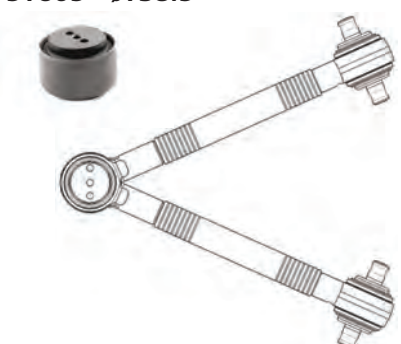

Auger Nr.	OEM Nr.	Description	Model	Picture	
<b>54189</b>	273 612	Rep. Kit for Axle Rod  ø95xø21/130	F 10 F 12 FH 12 FH 16 FL 10 FL 12 FL 7 FM 12 FM 9	NL 10 S N 10 N 10 USA N 12 N 12 USA NH 12 NH 12 BR NL 12 AUS NL 12 S	
<b>54571</b>	3198 309	Rep. Kit for Axle Rod  ø108xø25/152	---		
<b>54573</b>	3093 630 3093 631	Rep. Kit for Axle Rod  ø85x21/26x130	FH12 FH16 FM12 FM9 NH12		
<b>55287</b>	3093 630 S 3093 631 S	Rep. Kit for Axle Rod  ø85x21/26x130	FH12 FH16 FM12 FM9 NH12		
<b>54574</b>	3092 452	Rep. Kit for Axle Rod  ø75x17/20x115	FL12 FL6		
<b>54637</b>	3097 188	Rep. Kit for Axle Rod  ø85xM36x1.5/248	B10B B10BLE		
<b>55119</b>	2054 7286	Rep. Kit for Axle Rod  ø75xø19/115	FL6 FH12 FH16 FM9 FM12 NH12		







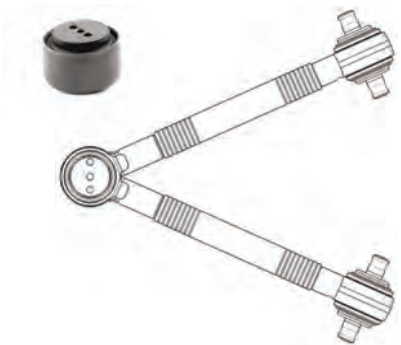

Auger Nr.	OEM Nr.	Description	Model	Picture		
<b>51587</b>	1135 080	Axle Rod Mounting  ø52xø91.3x85	B 10 M B 10 M BR B 10 B, B10 BLE B 10 R BR B 12 B 12 BR B 12 M B 12 M B 58 BR B 7 R B 7 R BR	B 9 S F 10 F 12 F 16 FH 12 FH 12 BR FS 7 NH 12 NH 12 BR  FL 616-619 FL 7 FM 10 FM 12 FM 7 FL 6 FL 608-615		
<b>51605</b>	2055 4908 3173 759 1075 255 1591 689	Axle Rod Mounting  M16xø138.5x96	B 10B, B10 BLE B 10 M B 12 BR B 12 B 12 M F 10 F 12 F 16 FH 12 BR FH 12 FH 12 J FH 16	FL 10 FL 12 FL 6 FL 7 FM 10 FM 12 FM 7 NH 12 NH 12 NL 10 BR NL 12 BR		
<b>52535</b>	1136 891	Axle Rod Mounting  ø91.3x150	B 10 B, B10 BLE B 10 M BR B 10 M B 10 R BR B 12 BR B 12			
<b>53291</b>	1598 588	Axle Rod Mounting  ø91.3x150 / 55 Shore A	B 10 L B 10 M B 10 M BR B 10 R BR B 10B B10 BLE B 12 B 12 BR B 12 M B 58 (BR) B 7 R B 7 R BR F 10 F 12	F 16 F S 7 FH 12 FH 12 BR FH 12 J FH 16 FL 10 FL 12 FL 6 FL 608-615 FL 616-619 FL 7 FM 10 FM 12	FM 7 NH 12 NH 12 BR NL 10 BR OLYMPIAN MKII SUPER- OLYMPIAN	
<b>51565</b>	1614 355	Axle Rod Mounting  ø91.3x150 / 65 Shore A	B 10 L F 10 F 12 F 16 FH 12 FH 16 FL 10 FL 12 FL 7 FM 10 FM 12	FM 7 SUPEROLYMPIAN		
<b>51566</b>	1628 107	Axle Rod Mounting  ø91.3x170	FH 12 BR FH 12 FH 12 J FH 16 FL 6 FM 10 FM 12 FM 7 NH 12 BR NH 12			

Auger Nr.	OEM Nr.	Description	Model	Picture
<b>54575</b>	2074 1710 3093 544	Rep. Kit for Axle Rod M20x1.5/ø72x46	FH12 FH16 FM9 FM12 NH12 FL6 FL12	
<b>51449</b>	273 375	Rep. Kit for Axle Rod ø90x23/152	F 12 F 10 N 10 USA N 12 USA FL 10 FL 7 FL 12 N 10 N 12	
<b>51450</b>	273 706 276 191	Rep. Kit for Axle Rod M24x1.5/ø90x59	F 10 F 12 F 16 FL 10 FL 12 FL 7 N 10 N 10 USA N 12 N 12 USA NL 10 BR NL 12 BR	
<b>51451</b>	271 188	Rep. Kit for Axle Rod M20x1.5/ø72x46	F 10 FH 12 BR FH 12 FH 16	
<b>51622</b>	273 374	Rep. Kit for Axle Rod M24x1.5/ø90x60	F 10 N 10 N 12	
<b>51623</b>	274 069	Rep. Kit for Axle Rod M20x1.5/ø72x46	F 10 F 12 F 16 FL 10 FL 12 FL 7 N 10 USA N 12 USA NL 10 AUS NL 10 S	

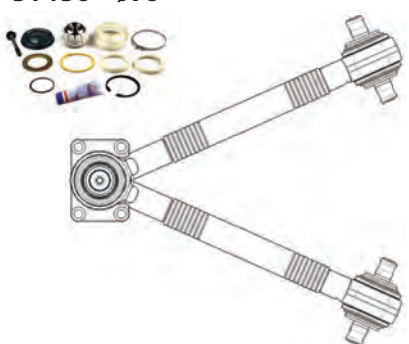
Auger Nr.	OEM Nr.	Description	Model	Picture
<b>51624</b>	3090 712	Rep. Kit for Axle Rod M14x1.5/ø90x60	FH 12 BR FH 12 FH 16 FH 16 J FM 10 FM 10 BR FM 12 FM 12 BR FM 7 FM 9 NH 12	NH 12 BR NH12 
<b>53010</b>	3090 015	Rep. Kit for Axle Rod ø20xø46x60	B 6 FL 6 1996 FL 608-615 FLC	
<b>53201</b>	3133 173	Rep. Kit for Axle Rod M20x1.5/ø72x46	---	
<b>51615</b>	1629 701	Plug ø21xø52.5x26	B 7 R B 7 R BR F 10/12/16 FH 12 FH 12 BR FH 12 J FH 16 FL 6/7/10/12 FL 608-615 FL 616-619 FM 7/10/12 FS 7	NH 12 NH 12 BR 

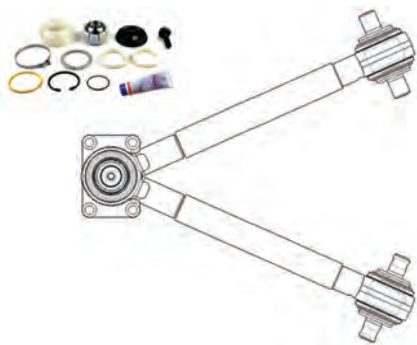

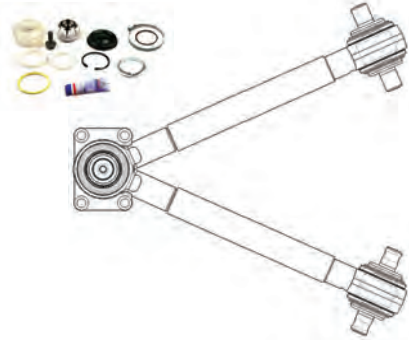
Auger Nr.	OEM Nr.	Description	Model	Picture
<b>15066</b>	1605 244	V-Arm	F10	
	1628 483		F12	
	3173 294	L: 690	F16	
	8156 994		FL7 FL10 FL12	
<b>15170</b>	20367 004	V-Arm	FL6	
	20741 703			
	20507 262	L: 662.4		
	20741 695			
<b>15172</b>	2055 6493	V-Arm	FH12, FL6	
	3173 297	L: 676.4		
<b>15173</b>	2055 6492	V-Arm	FM7, FM10, FM12, FH12, FH16	
		L: 660.3		

Auger Nr.	OEM Nr.	Description	Model	Picture
<b>15174</b>	2055 6491 3173 292	V-Arm L: 677	FM7, FM10, FM12, FH12, FH16	<p><b>51605 - <math>\varnothing</math>138.5</b></p>  <p><b>51566 - <math>\varnothing</math>91,3</b></p>   <p><b>51566 - <math>\varnothing</math>91,3</b></p> 
<b>15175</b>	2055 6488	V-Arm L: 666.3	FH12	<p><b>51605 - <math>\varnothing</math>138.5</b></p>  <p><b>51566 - <math>\varnothing</math>91,3</b></p>   <p><b>51566 - <math>\varnothing</math>91,3</b></p> 
<b>15063</b>	1082 104 1605 035	Torque Rod L: 665	F10 F12 F16 FL7 FL10 FL12 FH12 NH12 FL6 B7R	 <p><b>51587 - <math>\varnothing</math>91,3</b></p>  <p><b>53291 - <math>\varnothing</math>91,3</b></p> 
<b>15064</b>	8147 151	Torque Rod L: 620	FH12	 <p><b>51587 - <math>\varnothing</math>91,3</b></p>  <p><b>53291 - <math>\varnothing</math>91,3</b></p> 

Auger Nr.	OEM Nr.	Description	Model	Picture	
<b>15067</b>	3173 291	V-Arm	FH12	<b>51605 - ø138.5</b> 	<b>51566 - ø91,3</b> 
	2055 6490	L: 677.3	FH16 FM7 FM10 FM12 NH12		
<b>15075</b>	1576 952	V-Arm	F10	<b>51450 - ø90</b> 	<b>51619 - ø95</b> 
	1606 200 1080 690	L: 636	F12 F16 FL7 FL10 FL12 N10 N12 NL10 NL12		
<b>15146</b>	1606 552	V-Arm	F10	<b>51623 - ø72</b> 	<b>51134 - ø85</b> 
		L: 641	F12 F16 FL7 FL10 FL12 NL10 NL12		
<b>15147</b>	3172 829	V-Arm	FH12	<b>51451 - ø72</b> 	<b>51445 - ø75</b> 
	3173 829	L: 677	FH16 FM12 FL6 FL12		

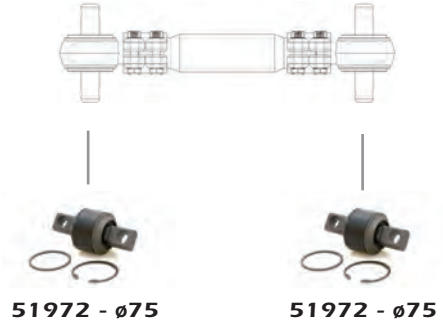
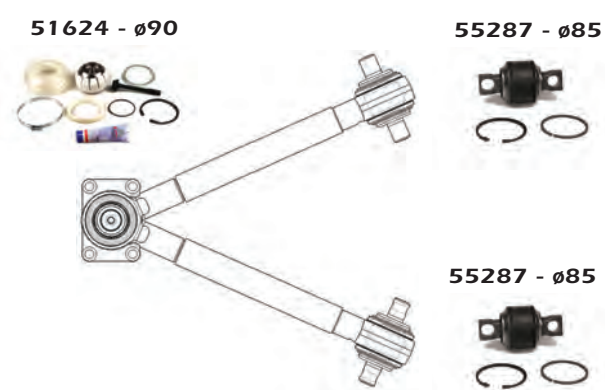
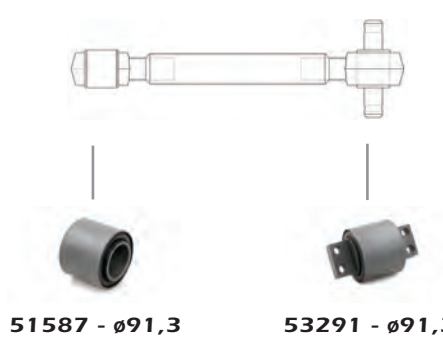
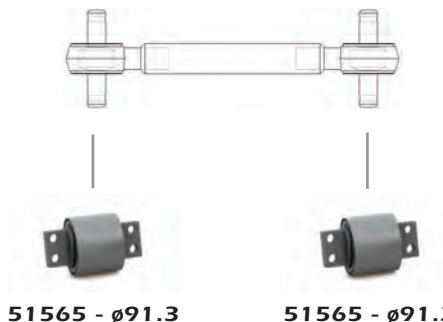

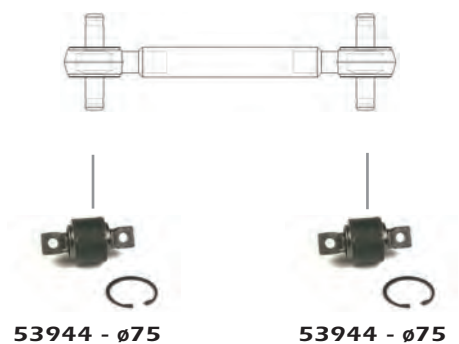
Auger Nr.	OEM Nr.	Description	Model	Picture
<b>15157</b>	1606 551	Torque Rod	F12	
	8154 016	L: 660	FL 7 FL 10 FL 12 N10 N12 NL12 NL10 F16	
<b>15159</b>	2039 2649	V-Arm	FH 12	
	1629 734 1076 639 2082 9503 1626 896	L: 671	FH 1 FM 9 FM 12 NH 12 FL 6	
<b>15176</b>	8190 034	Torque Rod	FH12	
		L: 566		
<b>15177</b>	1628 154	Torque Rod	FH16	
		L: 800	FH12 FM10 FM12 FM7	

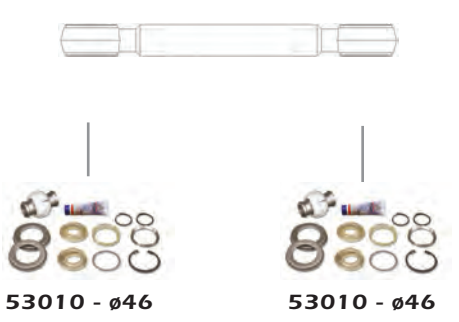
Auger Nr.	OEM Nr.	Description	Model	Picture
<b>15178</b>	2110 6157	Torque Rod	FH12	
	2041 0053	L: 799	FH16 FM12 FM9 FM7	
<b>15179</b>	4941 232	Torque Rod	---	
<b>15158</b>	6777 705	Stabilizer Rod	FL 6	
		L: 510	FLC 140 B 6 FL 608	

Auger Nr.	OEM Nr.	Description	Model	Picture
<b>10095</b>	1194 390	Tie Rod L: 1665	B10M	  <b>10098</b>  <b>10098</b>
<b>10449</b>	1584 620 1596 041	Tie Rod L: 720	F 16 FL 10 FL 12	  <b>10097</b>  <b>10097</b>
<b>10453</b>	2040 0909 3124 480 3124 594	Tie Rod L: 978	FL 6	  <b>10019</b>  <b>10019</b>
<b>10457</b>	2049 7798 3112 050 9959 151	Tie Rod L: 300	B10L B10B B10BLE B6BLE B7R B7L	
<b>10463</b>	1612 254 2039 3097 4510 697 3985 570	Tie Rod L: 1615	FH12 FH 16 FL 4 FM 12	  <b>10107</b>  <b>10107</b>

Auger Nr.	OEM Nr.	Description	Model	Picture
<b>10464</b>	1629 668 3986 433	Tie Rod L: 325	FH 12 FH 16 FL 4 FM 12	
<b>10476</b>	2039 3091 2044 2113 2051 3951	Tie Rod L: 2152	FM 7 FM 10 FM 12	  <b>10097</b>  <b>10097</b>
<b>10482</b>	6799 189	Tie Rod L: 890	FL 6	  <b>10104</b>  <b>10104</b>
<b>10490</b>	6790 607 6790 766	Tie Rod L: 871	FL 6	  <b>10003</b>  <b>10003</b>
<b>10532</b>	1629 397 20393 075	Tie Rod L: 853	---	  <b>10099</b>  <b>10099</b>

Auger Nr.	OEM Nr.	Description	Model	Picture
<b>10533</b>	3039 647	Tie Rod L: 1041	---	  <b>10003</b>  <b>10003</b>
<b>10534</b>	9517 016	Tie Rod Steering L: 1675	B 10	  <b>10110</b>  <b>10110</b>
<b>10535</b>	8132 373	Tie Rod Steering L: 022	---	  <b>10097</b>  <b>10097</b>
<b>10536</b>	1669 333	Tie Rod Steering L:	FL 7 FL 10 FL 12 FS 7	  <b>10523</b>  <b>10523</b>
<b>10537</b>	3173 613 3987 354	Ball Joint L: 435	---	

Auger Nr.	OEM Nr.	Description	Model	Picture
<b>10538</b>	20393 073 8190 147	Tie Rod L: 820	FH 12	   <b>10099</b> <span style="float: right;"><b>10099</b></span>
<b>10659</b>	9521 317	Tie Rod Steering L: 977	B 6	   <b>10003</b> <span style="float: right;"><b>10003</b></span>
<b>10103</b>	2039 3065 3988 764 3988 766	Drag Link L: 868	FM 7 FM 10 FM 12 FM 9 FH 12 FH 16	   <b>10099</b> <span style="float: right;"><b>10099</b></span>
<b>10441</b>	1626 751 1610 338	Drag Link L: 850	F 10 F 12 F 16	   <b>10097</b> <span style="float: right;"><b>10097</b></span>
<b>10442</b>	2039 3061 1075 153 3988 695 3988 697	Drag Link L: 850	FH 12 FH 16	   <b>10099</b> <span style="float: right;"><b>10099</b></span>

Auger Nr.	OEM Nr.	Description	Model	Picture
<b>10443</b>	1075 663	Drag Link	FH 12	  
	3988 704		FH 16	
	2039 3069	L: 870	FM 12 FL 4	
<b>10444</b>	1588 017	Drag Link	F 12	  
	1628 636			
	1577 080	L: 730		
	1505 857			
	1626 492			
<b>10445</b>	6790 474	Drag Link	F 12	  
			F 16	
		L: 855	F 4	
			F 7	
<b>10446</b>	1626 750	Drag Link	F 10	  
	1610 074		F 12	
		L: 850	F 16	
<b>10447</b>	1611 880	Drag Link	F 10	  
	1626 670			
		L: 835		

Auger Nr.	OEM Nr.	Description	Model	Picture
<b>10448</b>	3988 698	Drag Link L: 850	FH 12	  
	2039 3059		FH 16	
	8156 657		FL 4	
	8156 6572		FM 12	
	3988 700			
<b>10450</b>	1576 092	Drag Link L: 870	F 10	  
	1606 283		F 12	
			F 16	
<b>10451</b>	1626 671	Drag Link L: 1779	FL 10	  
	1613 351			
	1599 175			
<b>10452</b>	1075 664	Drag Link L: 870	FH 12	  
	2039 3063		FH 16	
	3988 701		FL 4 FM 12	
<b>10454</b>	1075 006	Drag Link L: 850	FH 12	  
			FH 16 FL 4 FM 7 FM 12	



Auger Nr.	OEM Nr.	Description	Model	Picture
<b>10455</b>	1592 940	Drag Link L: 810	FL 10 FL 12 FL 7	   <b>10097</b> <span style="float: right;"><b>10097</b></span>
<b>10456</b>	1075 005	Drag Link L: 863	FH 12 FH 16	   <b>10099</b> <span style="float: right;"><b>10099</b></span>
<b>10458</b>	2049 7800 3112 122 9959 153	Drag Link L: 763	FL 7 FL 10	   <b>10106</b> <span style="float: right;"><b>10106</b></span>
<b>10459</b>	1505 855 1606 274 1611 864 1626 494	Drag Link L: 1592	F 7 F 10 F 12 F 16 FL 10 FL 12 FL 6 FL 7	   <b>10099</b> <span style="float: right;"><b>10099</b></span>
<b>10460</b>	1628 637 3986 450 3988 711	Drag Link L: 1645	FH 12 FH 16 FL 4 FM 12	   <b>10099</b> <span style="float: right;"><b>10099</b></span>

Auger Nr.	OEM Nr.	Description	Model	Picture
<b>10461</b>	1576 093 1606 284	Drag Link L: 870	F 10 F 12 F 16	   <b>10097</b> <b>10097</b>
<b>10462</b>	6790 572 6790 5729	Drag Link L: 871	FL 6	   <b>10003</b> <b>10003</b>
<b>10465</b>	1194 824 1626 672	Drag Link L: 822	FL 10	   <b>10097</b> <b>10097</b>
<b>10466</b>	6771 112	Drag Link L: 1590	FL 6	   <b>10003</b> <b>10003</b>
<b>10467</b>	1071 316	Drag Link L: 910	FL 616 FL 619	   <b>10104</b> <b>10104</b>

Auger Nr.	OEM Nr.	Description	Model	Picture
<b>10468</b>	1968 601 6799 190	Drag Link L: 885	FL 6	 <p>10104                      10104</p>
<b>10469</b>	1083 744	Drag Link L: 848	F 10 F 12 F 16	 <p>10097                      10097</p>
<b>10470</b>	1626 749 1613 562	Drag Link L: 880	F 10 F 12 F 16	 <p>10097                      10097</p>
<b>10471</b>	1071 344 2040 0944	Drag Link L:	FL 6 FL 608-615	 <p>10003                      10003</p>
<b>10472</b>	1088 985 2039 3083	Drag Link L: 570	FH 12	 <p>10099                      10099</p>

Auger Nr.	OEM Nr.	Description	Model	Picture
<b>10473</b>	1080 786	Drag Link L: 844	FL 12	   <p>10097                      10097</p>
<b>10474</b>	1628 635 2039 3079 3988 708 3988 710	Drag Link L: 855	FH 12	   <p>10106                      10106</p>
<b>10475</b>	1194 819	Drag Link L: 1835	FH 12	
<b>10477</b>	1592 939	Drag Link L: 810	FL 10 FL 12 FL 7	   <p>10097                      10097</p>
<b>10479</b>	1197 338	Drag Link L: 1028	FL 10 FL 12 FL 7	   <p>10097                      10097</p>

Auger Nr.	OEM Nr.	Description	Model	Picture
<b>10480</b>	6771 120	Drag Link L: 1556	FL 4 FL 6 FLC	 <p>10019                      10019</p>
<b>10481</b>	2049 7799 3112 273 9959 152	Drag Link L: 743	B10L B10B B10BLE B7L B6BLE B7R	
<b>10483</b>	2049 0123 2074 5923 9519 278	Drag Link L: 1028	B10M MK4 B10B B10BLE B12	 <p>10111                      10111</p>
<b>10484</b>	1134 840	Drag Link L: 1044	---	 <p>10109                      10109</p>
<b>10485</b>	8158 944	Drag Link L: 739	NL 10 NL 12	 <p>10097                      10097</p>

Auger Nr.	OEM Nr.	Description	Model	Picture
<b>10486</b>	1588 263	Drag Link	F 10	  
	1606 277		F 12	
	1626 493	L: 710	F 16 FL 12 FL 7	
<b>10487</b>	1127 452	Drag Link	---	  
	1135 630	L: 1043		
<b>10488</b>	1612 779	Drag Link	FL 7	  
	3962 768	L: 1884	FL 10 FL 12	
<b>10675</b>	1070 199	Drag Link	FL 6	
		L:	67 -> 00	

Auger Nr.	OEM Nr.	Description	Model	Picture
<b>10003</b>	1517 577	Tie Rod End	FL 6	
	1695 690	L: 115		
	1697 247	M30x1,5 RHT		
	1696 057			
<b>10004</b>	1695 689	Tie Rod End	FL 6	
	1698 839	L: 115		
	1517 647	M30x1,5 LHT		
<b>10019</b>	1696 919	Tie Rod End	FL 4 FL 6 FLC 140	
		L: 105 M24x1,5 RHT		
<b>10020</b>	1696 920	Tie Rod End	FL 4 FL 6 FLC 140	
		L: 105 M24x1,5 LHT		
<b>10097</b>	1695 585	Tie Rod End	FL 7 FL 10 FL 12	
	1695 776	L: 125		
	1698 557	M30x1,5 RHT		
	1507 826			
	6882 111			
	0356 310			
<b>10098</b>	1698 840	Tie Rod End	FL 7 FL 10 FL 12	
	1131 744	L: 125		
	1698 558	M30x1,5 LHT		
	6869 744			
	6882 112			
	1313 744			

Auger Nr.	OEM Nr.	Description	Model	Picture
<b>10099</b>	1505 759	Tie Rod End  L: 125 M30x1,5 RHT	F 7	
	1507 823		F 10	
	1698 532		F 12	
	1698 846		F 16	
	3092 472		FL 6	
			FL 7	
			FL 10	
	FL 12			
<b>10100</b>	1505 758	Tie Rod End  L: 125 M30x1,5 LHT	F 7	
	1507 822		F 10	
	1698 533		F 12	
	1698 847		F 16	
	3092 471		FL 6	
			FL 7	
			FL 10	
	FL 12			
<b>10101</b>	1131 742	Tie Rod End  L: 170 M30x1,5 RHT	FL 7	
	1696 901		FL 10	
	1699 401			
<b>10102</b>	1131 741	Tie Rod End  L: 170 M30x1,5 LHT	FL 7	
	1696 900		FL 10	
	1699 400			
<b>10104</b>	1968 601 P	Tie Rod End  L: 90 M28x1,5 RHT	FL 6	
<b>10105</b>	1624 093	Tie Rod End  L: 86 M22x1,5 RHT	ALL TYPES	









Auger Nr.	OEM Nr.	Description	Model	Picture
<b>10106</b>	3090 727	Tie Rod End	FH 12	
	3988 965		FH 16	
	3110 002	L: 115 M30x1,5 RHT		
<b>10107</b>	3092 189	Tie Rod End	FH 12	
			FH 16	
		L: 141 M30x1,5 RHT	FM 12	
<b>10108</b>	1698 047	Tie Rod End	F 4	
	1506 269		F 6	
	1697 246	L: 125 M30x1,5 RHT	FL 4 FL 6	
<b>10109</b>	1134 840 P	Tie Rod End	---	
		L: 136 M30x1,5 RHT		
<b>10110</b>	3099 529	Tie Rod End	FH 12	
	3097 228		FH 16	
		L: 145 M30x1,5 RHT	FM 9 FM 12	
<b>10111</b>	3097 999	Tie Rod End	---	
	8510 4188	L: 128 M38x1,5 RHT		





Auger Nr.	OEM Nr.	Description	Model	Picture
<b>10522</b>	3090 728	Tie Rod End	FH 12	
	3110 001		FH 16	
	3988 968	L: 115 M30x1.5 LHT		
<b>10524</b>	1668 179	Tie Rod End	FH 12	
		L: 95 M16x1.5 RHT		
<b>10525</b>	1672 152	Tie Rod End	FH 16	
		L: 85 M14x1.5 RHT		
<b>10036</b>	6027 074 6853 913	Ball Joint	F 4	
			F 6	
		L: 86 M14x1,5 RHT	FL 4 FL 6	
<b>10498</b>	1190 131	Ball Joint	B 7R	
		L: 55 M12x1.75 RHT	B 10M BR B 10R BR B 58 BR	
<b>10499</b>	1190 132	Ball Joint	B 7R	
		L: 55 M12x1.75 LHT	B 10M BR B 10R BR B 58 BR	







Auger Nr.	OEM Nr.	Description	Model	Picture					
<b>10523</b>	382 613	Ball Joint  L: 56 M12x1.5 RHT	F 10						
			F 12						
			FL 10						
			FL 12						
			FL 7						
<b>10567</b>	1527 453	Ball Joint  L: 86 M14x1.5	B 10M BR						
			B 10R BR						
			B 7R BR						
			B 58 BR						
			NL 12 BR						
			N 10						
			N 12						
			NL 10 BR						
<b>10576</b>	1696 684	Ball Joint  L: 55 M12x1.75 LHT	B 10 M	FH 16					
			B 6	FH 16J					
			B 7	FL 6					
			B 7R	FL 608-					
			F 10	615					
			F 12	FL 616-					
			F 16						
			FH 12						
			<b>10577</b>	1696 685		Ball Joint  L: 55 M12x1.75 RHT	B 10 M	FH 16	
							B 6	FH 16J	
B 7	FL 6								
B 7R	FL 608-615								
F 10	FL 616-619								
F 12	FS 7								
F 16									
FH 12									
<b>10578</b>	1527 234 382 745	Ball Joint  L: 90 M28x1,5 RHT			B 10 M		FS 7		
					B 7		N 10		
			B 7 F	N 10 USA					
			B 7 R	N 12					
			F 10	N 12 USA					
			F 12	NL 10 AUS					
			F 16	NL 10 BR					
			F 7 USA	NL 10 S					
			FE 7 USA	NL 12 AUS					
			FL 10	NL 12 BR					
			FL 12	NL 12 S					
			FL 6						
			FL 616-619						
			FL 7						
			<b>10582</b>	3124 625	Ball Joint  L: 113 M14x1.5 RHT	FL 6			
FL 608-615									
FL 616-619									

Auger Nr.	OEM Nr.	Description	Model	Picture
<b>51724</b>	1607 468	Engine Mounting  M14x62	B 7 L B 7 L DD B 7 R BR FL10 FL 7 FS 7	
<b>51725</b>	1503 490 1503 489	Engine Mounting  104x148x43	F 10 F 12 F 16 F 7 USA FL 12 N 10 N 12	
<b>51726</b>	1573 891	Engine Mounting  127x187x254	F10 F12 N10 N10 USA N12 N12 USA NL10 AUS NL10 BR NL10 S NL12 AUS NL12 BR	
<b>51727</b>	1502 144 1623 745 1502 352 1618 777	Engine Mounting  120x147.5x44	F 10 F 12 F 16 F 7 USA N 10 N 10 USA N 12	
<b>51728</b>	1611 420	Engine Mounting  105x122x99.5	N 10 N 10 USA N 12 NL 10 AUS NL 10 BR NL 10 S NL 12 AUS NL 12 BR NL 12 S	
<b>53292</b>	1613 624	Engine Mounting  133x192x139.5	B 6 B 6 BLE B 7 F B 7 R BR B 7R F 10 F 12 FE 7 USA FL 10 FL 6 FL 608-615	FL 616-619 FL 7 FS 7  







Auger Nr.	OEM Nr.	Description	Model	Picture	
<b>53293</b>	1629 614	Engine Mounting 260x210x156	FH 12 FH 12 J FH 16 FH 16 J NH 12		
<b>52679</b>	1696 389	Propeller Shaft Bearing ø60	B 10 M B 10 M BR B 58 BR B 7 B 7F F 10 F12 FL 10 FL 12 FL 6 FL 608-615 FL 616-619	FL 7 FS 7 N 10 N 12	
<b>52680</b>	263 567	Propeller Shaft Bearing ø70	---		
<b>55428</b>	1651 230 263 006	Clamp	B10M (BR) B10M B58 (BR) B7 B7F F10 F12 F6 USA F7 USA FE6 USA FE7 USA FH12	FL12 FL6 FS7 N10 N10 USA N12 N12 USA NH12 NL10 BR NL12 NL12 BR	
<b>55429</b>	2109 6141 2047 1428 1068 222	Propeller Shaft Bearing ø70	FH12 FH16 FM10 FM12 FM7 FM9 NH12 BR NH12		
<b>53940</b>	2036 6968 3191 939	Ball Joint ø32xø131x96.5	FH 12 FH 12 BR FH 12 J FH 16 FH 16 J FH 565 FM 10 FM 10 BR FM 12 FM 12 BR FM 7 NH 565		

Auger Nr.	OEM Nr.	Description	Model	Picture
<b>54433</b>	2038 3598	Dust Protecting Rubber ø215x112	FM7 FM9 FM10 FM12 FH12 FH16 NH12	
<b>51721</b>	1614 600	Gearbox Mounting M10x54	B 10 R BR B 12 BR B 12 F 10 F 12 FL 12 N 10 NL 10 AUS NL 10 BR NL 10 S NL 12 AUS	NL 12 BR NL 12 S 
<b>51719</b>	1586 316	Gearbox Mounting 74x92x39	F 10 F 12 N 10	
<b>51720</b>	1605 093	Gearbox Mounting 74x103x39	F 10 F 12 FL 10 FL 7 N 10 N 12	
<b>51722</b>	1660 079	Bracket for Radiator 149x174x68	F 10 F 12	
<b>51723</b>	476 343	Bracket for Radiator 148x174x64.5	F 10 F 12	







Auger Nr.	OEM Nr.	Description	Model	Picture
<b>54951</b>	1676 744 1675 097 1675 579 2044 1625	Silicone Hose  ø76x245	FL6 FL 608/615 FL 616-619 NL 10 BR NL 12 BR NL 12 F 16 B6R B7R B9R B12B B10R	B7L B7L DD NL10S  
<b>54952</b>	2058 9122	Silicone Hose  ø100x148	FH12 FH16 FM12 FM9 NH12 B12M B9L B9S B9TL	
<b>54953</b>	2046 3924 2056 1450 1676 481 1676 491	Silicone Hose  ø100x148	FH12 FM10 FM10 BR FM17 FM7 FM9 B9R B9TL B12 B12M FH16	NH12 FL12 B12R  
<b>54954</b>	8149 800 1665 556	Silicone Hose  ø80x390	FH12 FM10 FM10 BR FM12 FM12 BR FM9 B12M FH16 NH12 FH565 NH565	
<b>54955</b>	1675 098 1660 264	Silicone Hose  ø76x305	---	
<b>54956</b>	2058 9123	Silicone Hose  ø80x390	FH12 FM10 FM10 BR FM12 FM12 BR FM9 B9L B9S B9R B9TL B12M	FH16 FL12 NH12 NH12BR FH565 NH565  

Auger Nr.	OEM Nr.	Description	Model	Picture
<b>55005</b>	466 328	Silicone Hose ø19x60	N12 NL10BR F6 OLYMPIAN F12 F16 NL10 NL12 B10R SUPER OLIMPIAN FM10 FM10BR	
<b>55006</b>	470 327	Silicone Hose ø76x60	N10 N12 NL12S NL12 B58BR	
<b>55007</b>	---	Silicone Hose ø25x100	---	
<b>55008</b>	470 464	Silicone Hose ø57x65	B10R BR B12 F12 NL12 NL12S B12 BR N12 NL12 BR	
<b>55009</b>	1195 081	Silicone Hose ø60x160	B12 B12 R B12 BR B10 L B10 M B10R BR B10B NL12 B12M B12B OLYMPIAN B7R	B9L B9S 
<b>55030</b>	1605 209	Silicone Hose ø21x65/90	F12	



Auger Nr.	OEM Nr.	Description	Model	Picture	
<b>55031</b>	3031 068	Silicone Hose ø60x90/160	B12B B10L B9R B12 B12M B10B B9L B9S		
<b>55032</b>	1195 576	Silicone Hose ø60x110/110	B58 BR B10M BR B10L B12B SUPER OLYMPIAN B10M N12L B10B B12M B12	B12R OLYMPIAN B7R B9S	
<b>55033</b>	3031 477	Silicone Hose ø60x95/200	B10L B10M B12 B12BR		
<b>55034</b>	8155 665	Silicone Hose ø19/ø40x375/95	FH16 FH12 FM12 FM9 FH565 NH565 NH12		
<b>55035</b>	8154 602	Silicone Hose ø19/ø40x380/90	FH16 FH12 FM12 FM9 FH565 NH565 NH12		
<b>55040</b>	1676 216 1660 277	Silicone Hose ø76x150/165/125	B7L		

Auger Nr.	OEM Nr.	Description	Model	Picture
<b>55041</b>	1676 218	Silicone Hose ø76x150/145/150	N10BR N12BR B7 B7F F16 NL10S	
<b>55042</b>	3028 329	Silicone Hose ø50/ø60x240	B10M B12B B12M B7R	
<b>55043</b>	9515 673	Silicone Hose ø50/ø60x170	B12 B10M	
<b>55044</b>	9519 701	Silicone Hose ø60x100/100/200	B12	
<b>55458</b>	2096 6083	Silicone Hose ø100x45	FH16	
<b>55459</b>	1676 199	Silicone Hose ø100x90	B7 B9 B12 FM7 FH16	
<b>55460</b>	8149 137	Silicone Hose ø86x100	FM 7 FM 10 B 7	

Auger Nr.	OEM Nr.	Description	Model	Picture	
<b>52649</b>	1619 106	Gas Spring 512 mm. / 150 N	FH 12 BR FH 12 FH 12 J FH 16 FH 16 J		
<b>52650</b>	3981 920	Gas Spring 392 mm. / 170 N	FH 12 FH 12 BR FH 12 J FH 16 FH 16 J NH 12 NH 12 NH 12 BR		
<b>52651</b>	1611 159	Gas Spring 785 mm. / 550 N	F 10 F 12 F 16 F L7 FL 10 FL 12 FL 7		
<b>52652</b>	1083 670 1624 101	Gas Spring 600 mm. / 290 N	F10 F12 F16		
<b>51688</b>	3090 935	Rubber Bushing for Shock Absorber  ø16xø42x66	F 10 F 12 F 16 FH 12 FH 12 BR FH 12 J FH 16 FH 16 J FL 10 FL 12 FL 7	FM 10 FM 10 BR FM 12 FM 12 BR FM 7 FM 9 NH 12 NH 12 BR NL 10 AUS NL 12 AUS	
<b>51689</b>	3090 934	Rubber Bushing for Shock Absorber  ø20xø42x50	F 10 F 12 FH 12 FH 12 J FH 16 FL 6 FL 616-619 FM 10 FM 12 FM 7 FM 9		
<b>51692</b>	3091 587	Rubber Bushing for Shock Absorber  ø16.2xø42x100	F10 F12 F16 B10M NL12 NL10 B6 FL12 FH12 Fh16 B7R	B12M FL6 FL7 FL10 FM7 FM9 FM10 FM12 NH12 B9S	

Auger Nr.	OEM Nr.	Description	Model	Picture	
<b>51730</b>	1134 962 308 852	Rubber Bushing for Shock Absorber  ø24.5xø48x25.5	FE 6 USA B 12 B 58 (BR) B 7 B 7 F B6 B7L B7L DD B7R CH F 10 F 12 F 16	F 6 USA F 7 USA FE 6 USA FE 7 USA FL 10 FL 12 FL 6 FL 608-615 FL 616-619 FL 7 FLC FS 7 N 10 N 12 N 12 USA N 10 USA NL 10 AUS NL 10 BR NL 10 S NL 12 AUS NL 12 BR	
<b>51919</b>	1698 046	Rubber Bushing for Shock Absorber  ø24.5xø40x39.5	F 10 F 12 F 16 FL 10 FL 12 FL 7		
<b>51922</b>	1697 732	Rubber Bushing for Shock Absorber  ø20.5xø59.5x31.5	F 10 F 12 F 16 FH 12 BR FH 12 FH 16 FL 10 FL 12 FL 6 FL 7 FM 10	FM 10 BR FM 12 FM 12 BR FM 7 FM 9 NH 12 NH 12 BR NH 12 NL 10 AUS NL 10 BR NL 10 S	
<b>53133</b>	1699 143	Rubber Bushing for Shock Absorber  ø19xø50x26	F 10 F 12 F 16 FL 10 FL 12 FL 7 NL 10 AUS NL 10 S NL 12 AUS NL 12 S		
<b>53134</b>	1697 731	Rubber Bushing for Shock Absorber  ø16xø42x50	B 6 F 10 F 12 F 16 FL 10 FL 12 FL 6 FL 608-615 FL 616-619 FL 7 FS 7	NL10 S	
<b>53985</b>	1586 076 1587 262	Return Spring  ø15x110	B 6 B 6 BLE B 7 B 7 F F 10 F 12 F 16 FE 7 USA FS 7 N 10 N 10 USA	N 12 N 12 USA NL 10 AUS NL 12 AUS	

Auger Nr.	OEM Nr.	Description	Model	Picture	
<b>51729</b>	6850 149 324 842	Rubber Mounting for Exhaust  M12xø50x42	B 10 B, B 10 BLE B 10 L B 10 M BR B 10 M B 10 R BR B 12 BR B 12 B 58 BR B 6 B 6 BLE B 7 B 7 F B 7 L B 7 L DD	B 7 R BR B 7 R F 10 F 6 USA F 7 USA FH 16 FL 6 FL C N 10 N 12 NL 10 BR NL 12 BR VOLVO 7000	
<b>51731</b>	1580 440	Rubber Mounting for Exhaust  M10xø50x42	F 7 USA		
<b>55059</b>	1676 687	Bellows  125x365x325	FH12 FH16 FM7 FM9 FM10 FM12 FH565 NH565		
<b>20108</b>	1081 785	Air Spring	F10 F12 FL10 FL12 FH12 FH16 FM10 FM12		
<b>20109</b>	2053 4645	Air Spring	FH12 FH16 FM7 FM9 FM10 FM12 FL10 FL12 F10 F12		
<b>20110</b>	2053 4646	Air Spring	FH12 FH16 FM7 FM9 FM10 FM12 FL10 FL12 F12		

Auger Nr.	OEM Nr.	Description	Model	Picture
<b>20001</b>	3950 209	Piston for Air Bellow ø197x170	F 10 F 12 F 16 FH 16 FL 10 FL 12 FL 6 FL 608-615 FL 616-619 FL 7 FS 7	
<b>20006</b>	2045 6152 S 6608 N P01 S	Piston for Air Bellow ø168x182	FH12 FH16 FM9 FM12 FM7	
<b>20007</b>	2045 6156 S 6607 N P01 S	Piston for Air Bellow ø168x168	FH12 FH16 FM9 FM12 FM7 FL6	
<b>20008</b>	2045 6150 S 6605 N P01 S	Piston for Air Bellow ø200x182	FH12 FH16 FM9 FM12 FM7	
<b>20009</b>	2045 6154 S 6606 N P01 S	Piston for Air Bellow ø198x169	FH12 FH16 FM9 FM12 FM7 FL6	
<b>51667</b>	1134 566	Rubber Buffer ø85x75	B 10 B, B 10 BLE B 10 L B 10 M BR B 10 M B 10R BR B 12 BR B 12 B 12 B B 12 M B 58 BR B 6 B 6 BLE B7L B 7 L DD B 7 R BR B 7 R F 10 F 12 F 16 FH 12 FH 12 J FH 16 FL 10 FL 12 FL 6 FL 608-615 FL 616-619 619 FL 7 FLC FM 10 FM 12 FM 7 FM 9	

Auger Nr.	OEM Nr.	Description	Model	Picture
<b>55058</b>	2080 6212 3191 967	Ball Joint  ø14xø35x14/27.5	FH12 FH16 FM7 FM9 FM12 NH12 FH565 NH565 B12	
<b>55526</b>	8172 031	Clutch Release Fork	FH12 FM9 FM12	
<b>55527</b>	3191 966	Clutch Release Fork	FH12 FH16 FM12 FM7 FH565 NH565 NH12	
<b>55528</b>	8510 5618 8510 6479	Repair Kit For Clutch Release Fork	FH12 FH16 FM12 NH12	
<b>55529</b>	8172 031 S	Repair Kit For Clutch Release Fork	FH12 FM9 FM12	

