

07

R.V.I.

Group	Page
Spring Suspension	001
Cabin	017
Stabilizer	027
Brake	036
Axle & Wheel	050
Steering & Suspension	058
Engine	078
Shaft	085
Gearbox	087
Radiator & Fan Group	087
Exhaust	089
Shock Absorber & Gas Spring	089
Clutch	091
Oil & Air Filter	091
Gas-Pedal	092
Air Suspension	092

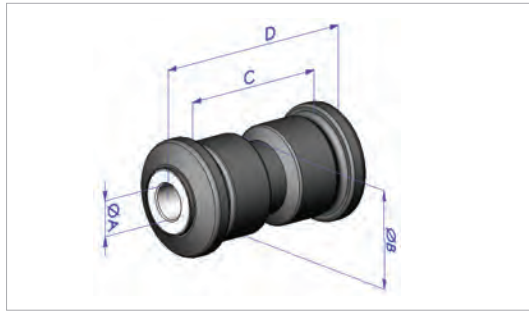



Auger Nr.	O.E.M. Nr.	A	B	C	D	Repair Kit
53617	5000 448 404	ø16	ø43.5	66	95	53724
53650	5000 448 405	ø20	ø54	66	95	53722
53677	5010 294 961	ø16	ø43	60	81	-
54312	5010 294 770	ø20	ø53.5	60	81	-

Auger Nr.	OEM Nr.	Description	Model	Picture
53617	5000 448 404	Rubber Bushing for Spring ø16xø43.5x95	M140/160/200/230 MIDLINER GRANDE-BRETAGNE M/S 150/180/210/220/230TI/250 PA200/210 MIDLUM(FAB42B1/2-43C1/2-43T/V) MIDLUM EXPORT (FAB 43E1-43E2) MIDLUM 42B3/4-44T/V/C.-45D./E. MIDLUM 4X4 47XA/47XC MIDLUM CCF 4X4 (FAB 47XF) MIDLUM(FAB 42US-44US-45US)	
53650	5000 448 405	Rubber Bushing for Spring ø20xø54x95	M140/160/200/230 MIDLINER GRANDE-BRETAGNE M/S 150/180/210/220/230TI/250 PS150/160 PA200/210 MIDLUM(FAB42B1/2-43C1/2-43T/V) MIDLUM EXPORT (FAB 43E1-43E2) MIDLUM 42B3/4-44T/V/C.-45D./E. MIDLUM 4X4 47XA/47XC MIDLUM CCF 4X4 (FAB 47XF) MIDLUM(FAB 42US-44US-45US)	
53677	5010 294 961	Rubber Bushing for Spring ø16xø43x81	MIDLUM(FAB42B1/2-43C1/2-43TA) MIDLUM 42B3/4-44TA/V/C.-45D./E. MIDLUM(FAB 42US-44US-45US)	
54312	5010 294 770	Rubber Bushing for Spring ø20xø53.5x81	MIDLUM 42B3/4-44T/V/C.-45D./E MIDLUM(FAB 42US-44USI-45US)	

Auger Nr.	OEM Nr.	Description	Model	Picture
54309	5010 066 115	Rubber Bushing for Spring ø21xø56.5x85	AE380/385TI/420TI/500/520 AE MAGNUM390/420TI/430/470/560	
54310	5010 066 116	Rubber Bushing for Spring ø25xø68.5x85	AE380/385TI/420TI/500/520 AE MAGNUM390/420TI/430/470/560	
51218D	5010 557 698	Rubber Bushing for Spring ø24xø62x96	MAGNUM DXI 12-VAR-12AV PREMIUM DXI 11-FAB-27JC/TC PREMIUM DXI 11-FAB-27RC/SC	
52058	5010 052 742	Rubber Bushing for Spring ø65.5xø104.5x132.5	R310/330/340/365 1984—> M140/160/200/230 AE380/385TI/420TI/500/520 MIDLINER GRANDE-BRETAGNE R 1990—>1992 M/S 150/180/210/220/230TI/250 R 1993—> G220/270 BOM AE MAGNUM390/420TI/430/470/560	
52217	5000 815 738	Rubber Bushing for Spring ø30xø68x104	G260/290 R370/390/420 —>1989 R310/330/340/365 1984—> AE380/385TI/420TI/500/520 R 1990—>1992 R 1993—> G MANAGER 4X2 G MANAGER 6X2 & 6X4 AE MAGNUM390/420TI/430/470/560	
53647	5001 852 218	Rubber Bushing for Spring ø30xø70x104	AE380/385TI/420TI/500/520 G340TI TR 18T MAGNUM KERAX MIDLUM PREMIUM	
53687	5010 052 741	Rubber Bushing for Spring ø30xø85x127	R310/330/340/365 1984—> M140/160/200/230 AE380/385TI/420TI/500/520 MIDLINER GRANDE-BRETAGNE R 1990—>1992 M/S 150/180/210/220/230TI/250 R 1993—> G220/270 BOM AE MAGNUM390/420TI/430/470/560	

Auger Nr.	OEM Nr.	Description	Model	Picture
53648	5010 137 848	Rubber Bushing for Spring ø24xø61x90.5	M140/160/200/230 AE380/385TI/420TI/500/520 M/S 150/180/210/220/230TI/250 G220/270 BOM AE MAGNUM390/420TI/430/470/560	
53675	5001 859 721	Rubber Bushing for Spring ø24xø61.5x96.5	MAGNUM E-TECH 400/440/480 PREMIUM TR 4X2 2000 ==> PREMIUM TRACTEUR 4X2(FAB 22CC) PREMIUM(FAB22EE/HA/HB/JJ/QQ/RR) PREMIUM PR 4X2 (FAB 22AA/AB) KERAX (FAB 33AA.././SS)	
54176	5010 130 652	Rubber Bushing for Spring ø63.5xø111x146	MAXTER 6X4 8X4 KERAX ==> 1999 KERAX FAB 33A==>S 2000==>2002 KERAX (FAB 33AA.././SS)	
54311	5010 557 875	Rubber Bushing for Spring ø24xø61.5x95	MAGNUM DXI 12-VAR-120AV PREMIUM DXI 11-FAB-27JC/TC PREMIUM DXI 11-FAB-27RC/SC	
54356	5010 630 625	Rubber Bushing for Spring ø20xø50x96	PREMIUM DXI 11-FAB-27JC/TC PREMIUM DXI 11-FAB-27RC/SC MAGNUM DXI 12-VAR-120AV	
55506	7482 139 627 5001 867 795	Rubber Bushing for Spring ø24xø60x63	MAGNUM DXI12 FAB17JD/RD/SD/TD PREMIUM -TR--FAB-27JC/TC PREMIUM -PR--FAB-27RC/SC PREMIUM DXI 7 -FAB-29.B/29.G MAGNUM DXI13 FAB17JE/RE/SE/TE PREMIUM -TR--FAB-24.F/25.C PREMIUM -PR--FAB-24.F/25.C	
55508	7420 839 455	Rubber Bushing for Spring ø24xø61.5x87	PREMIUM DXI 7 -FAB-29.B/29.G PREMIUM -PR-FAB-24.F/25.C	

Auger Nr.	OEM Nr.	Description	Model	Picture	
52059	5010 383 950	Spring Buffer M12/ø79.5x121	GBH/TBH280 1981--> GBH260/280 6X6 GBH260/280 6X4 -->1980 GLM/TLM280 R370 JSQ 1984 R370/390/420 -->1989 R310/330/340/365 1984--> CBH/CLM280/340 R 1990-->1992 M/S 4X4 & INCENDIE MAXTER 6X4 8X4 CBH/CLM 320/385 R 1993--> G340TI 6X6	MAXTER 4X2-4X4 KERAX ==> 1999 KERAX FAB 33A==>S 2000==>2002 KERAX (FAB 33AA./../SS) KERAX (FAB33A./../R) 2003==> KERAX 33G ARMEE BANGLADESH KERAX 33K ARMEE BANGLADESH	
54652	5010 383 951	Spring Buffer M12/ø79.5x101	R370 JSQ 1984 R370/390/420 --->1989 R310/330/340/365 1984---> R 1990--->1992 R 1993---> KERAX ==> 1999 MIDLUM(FAB42B1/2-43C1/2-43T/V) KERAX FAB 33A==>S 2000==>2002 MIDLUM 42B3/4-44T/V/C,-45D./E. KERAX (FAB 33AA./../SS) KERAX (FAB33A./../R) 2003==> KERAX DXI 11 -FAB-34.C/34.F KERAX DXI 13 -FAB-36.D/36.E		
53666	5010 383 949	Spring Buffer M10/ø63.5x51.5	GB131/HR15 GB/TB191/ 231 GR191/ 231 - GRH235/ HF26 - G260/ 230 C260/ 290 -C210/ CLR220 G170 - G210/ 230-G320 AE380/ 385TV 420TI/ 500/ 520 MAXTER 6X4 8X4 G230/270 SP G220/270 BOM G200/ 210/ 230TI G MANAGER 4X2 G MANAGER 6X2 & 6X4 - PREMIUM TR 4X2 ==>1999 ==>1999 PREMIUM 6X2&6X2/4 ==>1999 AE MAGNUM390/420TI /430/470/560 PREMIUM PR 4X2 ==> 1999 KERAX ==> 1999	PG230280 MAGNUM E- TECH - 400/ 440/ 480 PREMIUM TR 4X2 2000 ==> PREMIUM(FAB22E/ HV/ J/ Q/ R) 2000==> PREMIUM PR 4X2 (FAB22A)2000==> KERAX FAB 33A==>S 2000==>2002 PREMIUM TRACTEUR 4X2(FAB 22CC) PREMIUM(FAB22EE/ HA/ HB/ JJ/ QQ/ RR PREMIUM PR 4X2 (FAB 22AA/AB) KERAX (FAB 33AA./../SS) MAGNUM DXI 12 -VAR-120/AB PREMIUM DXI 11 -FAB- 27RC/SC	
51241	5000 288 447	Spring Buffer 55x80.5x14	S110/130 (VF6JK) S100 MIDLINER GRANDE-BRETAGNE S140/160 B80/110/120 M/S 150/180/210/220/230TI/250 S120/135 S135/150 (MOT 040226) MASCOTT MASCOTT DXI		
51679	5001 832 708	Spring Buffer 90x100x10.5	R 1990-->1992 R 1993--> G340TI TR 18T PREMIUM TR 4X2 ==>1999 PREMIUM TR 4X2 2000 ==> PREMIUM 22C 071==> 1999		
54338	5001 834 111	Spring Buffer 80x100x11	AE380/385TI/420TI/500/520 G MANAGER 4X2 AE MAGNUM390/420TI/430/470/560 KERAX==>1999 MAGNUM E-TECH 400/440/480 PREMIUM TR 4X2 2000 ==> PREMIUM TRACTEUR 4X2(FAB 22CC) KERAX (FAB 33AA./../SS)		

Auger Nr.	OEM Nr.	Description	Model	Picture
53970	0000 750 383	Spring Buffer M10/106/121x66	GRH235/HF26 CBH/CLM280/340 GRH/TRH305 R 1990 → 1992 GRH/TRH350 MAXTER 6X4 8X4 GBH/TBH280 1981-> CBH/CLM 320/385 GBH260/280 6X6 R 1993 → GBH260/280 6X4 G MANAGER 6X2 & R360 6X4 → 10/1983 6X4 - G340TI 6X6 R310 6X4 JSQ 8/1984 KERAX ==> 1999 110-130 6X6 KERAX(FAB33AA/./S) R370 JSQ 1984 2000 ==> R370/390/420 → 1989 KERAX(FAB33AA/./SS) R310/330/340/365	
54339	5001 853 313	Spring Buffer 60x60x18/46	MIDLUM(FAB42B1 /2-43C1 /2-43T/V) MIDLUM 42B3/4-44T/V/C.-45D./E. MIDLUM 4X4 47XA/47XC MIDLUM CCF 4X4 (FAB 47XF) MIDLUM(FAB 42US-44US-45US)	
54340	5001 014 359	Spring Buffer 66x80x18/46	M140/ 160/ 200/ 230 MIDLINER GRANDE-BRETAGNE M/S 150/180/210/220/230TI/250 PREMIUM PR 4X2 ==> 1999 PA200/ 210 PREMIUM 260 SP MIDLUM(FAB42B1 /2-43C1/2-43T/V) PREMIUM PR 4X2 (FAB22A)2000==> MIDLUM EXPORT (FAB 43E1-43E2) MIDLUM 42B3/4-44T/V/C.-45D./E. MIDLUM 4X4 47XA/47XC PREMIUM PR 4X2 (FAB 22AA/AB) MIDLUM(FAB 42US-44US-45US)	
54341	5001 834 501	Spring Buffer 80x86x22/52	PREMIUM PR 4X2 ==> 1999 PREMIUM 260 SP	
54367	5000 745 055	Spring Buffer 95x120/126x77	GB131/HR15 GB/TB191/231 GC191/231 TF231D GF151D PGC191/231 GLC/GLR190/230 G260/290 G170 G210/230 G320 G230/270 SP G200/210/230TI G MANAGER 4X2	
54368	5000 745 612	Spring Buffer 50x126x14	GB131/HR15 G230/270 SP GB/TB191/231 G200/210/230TI GC191/231 G MANAGER 4X2 TF231D GF151D PGC191/231 GLC/GLR190/230 G260/290 G170 G210/230 G320	

Auger Nr.	OEM Nr.	Description	Model	Picture
51665	7420 390 836	Spring Cushion h:151	PREMIUM 440-450 KERAX DXI	
54286	5010 130 653	Spring Cushion h:140	MAXTER 6X4 8X4 KERAX ==> 1999 KERAX FAB 33A==>S 2000==>2002 KERAX (FAB 33AA/././SS)	
54308	5010 130 654	Plastic Bushing for Spring ø64xø75.5x70	MAXTER 6X4 8X4 KERAX==>1999 KERAX FAB 33A==>S 2000==>2002	
54315	5001 862 978	Plastic Bushing for Spring ø35xø45x75	PREMIUM TR 4X2 ==>1999 PREMIUM PR 4X2 ==> 1999 MAGNUM E-TECH 400/440/480 PREMIUM(FAB22E/H/J/Q/R)2000==> PREMIUM(FAB22EE/HA/HB/JJ/QQ/RR)	
54373	0000 715 368	Spring Buffer ø20xø79x61	GR/TR280	
53968	0000 777 903	Spring Buffer 56x81x43.5	GRH/ TRH305 CCH300 GRH/ TRH350 MAXTER 6X4 8X4 GBH/TBH280 1981 -> CBH/CLM 320/385 GBH260/280 6X6 R 1993-> C260/ 290 G340TI 6X6 R360 6X4 -> 10/1983 KERAX ==> 1999 R310 6X4 JSQ 8/1984 KERAX FAB 33A==>S R370 JSQ 1984 2000==>2002 R370/390/420 ->1989 KERAX (FAB R310/330/340/365 33AA/././SS) 1984-> KERAX (FAB33A/./R) CBH/ CLM280/ 340 2003==> R 1990->1992 C230/ 280/ 300/ 340TI/	



Auger Nr.	O.E.M. Nr.	A	B	Type
51463	5000 286 235	ø25	143	1
53698	0000 758 346	ø32	166	1
54317	5810 110 749	ø28	216	1
54318	5000 703 619	ø28	142	1
54319	0005 000 598	ø20	106	1
54320	0000 743 176	ø32	153	1
54321	0000 723 727	ø28	132	1
54322	0000 796 874	ø36	163	1
54323	0000 743 098	ø24	142	1
54326	0000 729 137	ø32	160	1
54328	0000 743 064	ø22	124.5	1
54329	0000 716 814	ø28	142	1
54330	5010 164 592	ø30	136	1
54332	0005 011 686	ø24	130.5	1
54334	5000 285 345	ø30	162.5	1
54335	5000 745 493	ø30	155	1
53697	5010 064 632	ø28	146.5	2
54327	5000 740 956	ø32	160.5	2
54333	5430 022 286	ø35	174.5	2
54336	5810 111 800	ø28	145	2
54337	5430 044 067	ø35	175	2
54324	5000 435 084	ø30	149	3
54325	5000 546 979	ø25	131.5	3
54331	0000 790 396	ø32	164	4

Auger Nr.	OEM Nr.	Description	Model	Picture
51463	5000 286 235	Spring Pin ø25x143	---	
53697	5010 064 632	Spring Pin ø28x146.5	GBH/TBH280 1981→ GLM/TLM280 CBH/CLM280/340 MAXTER 6X4 8X4 CBH/CLM 320/385 G340TI 6X6 MAXTER 4X2-4X4 KERAX ==> 1999 KERAX FAB 33A==>S 2000==>2002 KERAX (FAB 33AA/././SS) KERAX (FAB33A/./R) 2003==> KERAX 33G ARMEE BANGLADESH KERAX 33K ARMEE BANGLADESH	
53698	0000 758 346	Spring Pin ø32x166	TR/ GR305 - TR/ GR350 - GR191/ 231 GR/ TR280 -R310 4X2 ->8/84 R360 4X2 - GLC/ GLR190/ 230 GLM/ TLM280 - GLR230 4X4 SINPAR G210/ 230/ 260/ 290/ 320 R370 JSQ 1984 - R370/390/420 →1989 R310/330/340/365 1984→ CBH/ CLM280/ 340 - R 1990→1992 CBH/CLM 320/385 - R 1993→ G220/270 BOM - G200/ 210/ 230TI G MANAGER 4X2-G MANAGER 6X2 & 6X4 KERAX FAB 33A==>S 2000==>2002 KERAX (FAB33A/./R) 2003==>	
54317	5810 110 749	Spring Pin ø28x216	G260/290 G MANAGER 6X2 & 6X4	
54318	5000 703 619	Spring Pin ø28x142	GR191/231 TF231D - GF151D GLC/GLR190/230 G260/290 G170 G210/230 G320 G230/270 SP G220/270 BOM G200/210/230TI G MANAGER 4X2 G MANAGER 6X2 & 6X4 G340TI 4X4 PG230/280	
54319	0005 000 598	Spring Pin ø20x106	---	

Auger Nr.	OEM Nr.	Description	Model	Picture
54320	0000 743 176	Spring Pin ø32x153	GB/TB191/231 GC191/231 GF151D PGC191/231 GLC/GLR190/230 G260/290 G170 G210/230 G230/270 SP G200/210/230TI G MANAGER 4X2	
54321	0000 723 727	Spring Pin ø28x132	770KB6 SP	
54322	0000 796 874	Spring Pin ø36x163	TF231D G260/290 G320 G MANAGER 4X2 G340TI 4X4	
54323	0000 743 098	Spring Pin ø24x142	GB131/HR15 GB/TB191/231	
54324	5000 435 084	Spring Pin ø30x149	---	
54325	5000 546 979	Spring Pin ø25x131.5	PJK/ PJJ/ PJP - JN55/ 60/ 85 JK55/ 60/ 65/ 75 - J& S4X4→ 5/ 1991 S130/150TI (VF6JN) - S110/ 130 (VF6JK) S100 - MIDLINER GRANDE-BRETAGNE S140/ 160 M/S 150/180/210/220/230TI/250 PS150/ 160 - S120/ 135 S135/150 (MOT 040226) MIDLUM(FAB42B1 /2-43C1/2-43T/V) MIDLUM 42B3/4-44T/V/C.-45D./E. MIDLUM(FAB 42US-44US-45US)	

Auger Nr.	OEM Nr.	Description	Model	Picture	
54326	0000 729 137	Spring Pin ø32x160	TR/ GR305 TR/ GR350 GR/ TR280 GRH/ TRH305 GRH/ TRH350 R310 4X2—>8/84 R360 4X2 G260/ 290 R360 6X4- >10/1983 R310 6X4 JSQ 8/1984	R370 JSQ1984 R370/ 390/ 420-> 1989 R310/330/340/365 1984—> R 1990—>1992 R 1993—> G MANAGER 6X2 & 6X4---	
54327	5000 740 956	Spring Pin ø32x160.5	---		
54328	0000 743 064	Spring Pin ø22x124.5	GB131/HR15 GB/TB191/231 110-130 6X6 770KB6 SP		
54329	0000 716 814	Spring Pin ø28x142	GC191/231 GR191/231 GRH235/HF26 GBH/TB280 1981-> PGC191/231 GBH260/280 6X6 GBH260/280 6X4- >1980 GLC/GLR190/230 G260/290 GLM/TLM280 GLR230 4X4 SINPAR	G170 G210/230 G320 G230/270 SP G220/270 BOM G200/210/230TI G MANAGER 4X2 & G MANAGER 6X2 & 6X4 G340TI 4X4 G340TI TR18T PG230/280	
54330	5010 164 592	Spring Pin ø30x136	PJK/PJN/PJP - JE13/15 - JP11/13 JR/JX19/21 - S170 (FAB=SH) J&S4X4—>5/1991 - S130/150TI (VF6JN) S130/150TI/170 (VF6JP) M140/160/200/230 M/S 4X4 & INCENDIE ME/SE/CE/160/180/210 PS150/160 - M210 4X4 MS300 SUDAMERICA MIDLUM EXPORT (FAB 43E1-43E2) MACK MS200/250/300 1990—> MACK CS200/250/300 1990—>		
54331	0000 790 396	Spring Pin ø32x164	TR/GR305 - TR/GR350 - GR/TR280 GRH/TRH305 - GRH/TRH350 R310 4X2—>8/84 - R360 4X2 R360 6X4—>10/1983 R310 6X4 JSQ 8/1984 - R370JSQ1984 R370/390/420—>1989 R310/330/340/365 1984—> R 1990—>1992 - R 1993—> G MANAGER 6X2 & 6X4		
54332	0005 011 686	Spring Pin ø24x130.5	---		

Auger Nr.	OEM Nr.	Description	Model	Picture
54333	5430 022 286	Spring Pin ø35x174.5	G260/290 G MANAGER 6X2 & 6X4	
54334	5000 285 345	Spring Pin ø30x162.5	---	
54335	5000 745 493	Spring Pin ø30x155	G260/290 G170 G210/230 G320 G200/210/230TI G MANAGER 4X2	
54336	5810 111 800	Spring Pin ø28x145	G MANAGER 6X2&6X4	
54337	5430 044 067	Spring Pin ø35x175	AE380/385TI/420TI/500/520 R 1993→ PREMIUM TR 4X2 ==>1999 PREMIUM 6X2&6X2/4 ==>1999 AE MAGNUM390/420TI/430/470/560 PREMIUM PR 4X2 ==> 1999 MAGNUM E-TECH 400/440/480 PREMIUM(FAB22E/H/J/Q/R)2000==> PREMIUM(FAB22EE/HA/HB/JJ/QQ/RR	
53701	0000 466 526	Spring Pin M16x2/232	GRH/TRH305 - GRH/TRH350 GBH/TBH280 1981-> - GBH260/280 6X6 GLC/GLR190/230 - C260/290 R360 6X4 → 10/1983 R310 6X4 JSQ 8/1984 - KERAX ==> 1999 GLR230 4X4 SINPAR - R 1993→ R370 JSQ 1984 - R370/390/420 →1989 R310/330/340/365 1984→ CBH/CLM280/340 - R 1990→1992 C230/280/300/340TI/CCH300 CBH/CLM 320/385 - MAXTER 4X2-4X4 KERAX FAB 33A==>S 2000==>2002 KERAX (FAB 33AA.././SS) KERAX (FAB33A.././R) 2003==>	
54066	5010 130 738	Spring Pin M20x1.5/160	G260/290 - G210/230 - G320 AE380/385TI/420TI/500/520 MAXTER 6X4 8X4 - G230/270 SP G220/270 BOM - G200/210/230TI G MANAGER 4X2 G MANAGER 6X2 & 6X4 G340TI 6X6 - G340TI 4X4 MAXTER 4X2-4X4 AE MAGNUM390/420TI/430/470/560 KERAX==>1999 MAGNUM E-TECH 400/440/480 PREMIUM TR 4X2 2000 ==> KERAX FAB 33A==>S 2000==>2002 PREMIUM TRACTEUR 4X2(FAB 22CC) PREMIUM(FAB22EE/HA/HB/JJ/QQ/RR PREMIUM PR 4X2 (FAB 22AA/AB) KERAX (FAB 33AA.././SS) KERAX (FAB33A.././R) 2003==>	

Auger Nr.	OEM Nr.	Description	Model	Picture
52011	5010 060 127	Spring Bushing ø20xø44.5x104	G260/290 G210/230 G230/270 SP G220/270 BOM G200/ 210/230TI GMANAGER G340TI 6X6 G340TI 4X4 G340TI TR 18T MAXTER MAGNUM KERAX PREMIUM	
53695	5001 851 118	Spring Bushing ø28.2xø34.2x89.3	GC191/231 GR191/231 GRH235/HF26 TF231D GF151D GBH/TBH280 1981-> PGC191/231 GBH260/280 6X6 GBH260/280 6X4->1980 GLC/GLR190/230 GLM/TLM280 GLR230 4X4 SINPAR G170/210/230/320/260/290 CBH/CLM280/340 MAXTER 6X4 8X4 CBH/CLM 320/385 G230/270 SP G220/270 BOM G200/210/230TI G MANAGER 4X2 G MANAGER 6X2 & 6X4 G340TI 6X6 4X4 G340TI TR 18T MAXTER 4X2-4X4 KERAX ==> 1999 PG230/280 KERAX FAB 33A==>S 2000==>2002 KERAX (FAB 33AA/.../SS) KERAX (FAB33A//R) 2003==>	
53696	5000 710 780	Spring Bushing ø36xø44.5x89	G260/ 290 C260/ 290 C210/ CLR220 G320 C230/ 280/ 300/ 340TI/ CCH300 G MANAGER 4X2 G340TI 4X4 MAXTER 4X2-4X4 KERAX ==> 1999 KERAX FAB 33A==>S 2000==>2002 KERAX (FAB 33AA/.../SS) KERAX (FAB33A//R) 2003==>	
54316	5000 542 198	Spring Bushing ø25xø32x70	PJK/ P.JN/ PJP JN55/ 60/ 85 JK55/ 60/ 65/ 75 S130/150TI (VF6JN) S110/ 130(VF6JK) S100 MIDLINER GRANDE-BRETAGNE S140/ 160 M/S 150/180/210/220/230TI/250 PS150/ 160 S120/ 135 S135/150 (MOT 040226) MIDLUM(FAB42B1 /2-43C1/2-43T/V) MIDLUM 42B3/4-44T/V/C-45D./E. MIDLUM(FAB 42US-44US-45US)	
53663	5010 052 740	Bushing for Spring Pin M24x3/ø65x61	R310/330/340/365 1984-> M140/160/200/230 AE380/385TI/420TI/500/520 MIDLINER GRANDE-BRETAGNE R1990->1992 M/S 150/180/210/220/230TI/250 R 1993-> G220/270 BOM AE MAGNUM390/420TI/430/470/560	
54918	5010 130 670	Bushing for Spring Pin ø28.5xø63.5x78	MAXTER 6X4 8X4 KERAX ==> 1999 KERAX FAB 33A==>S 2000==>2002 KERAX (FAB 33AA/.../SS)	





Auger Nr.	O.E.M. Nr.	A	B	C	Type	Repair Kit
53701	0000 466 526	M16x2	232	ø23.5	1	-
54798	5003 101 582	M20x1.5	130	SW 30	2	54388
54799	5003 101 490	M24x2	150	SW 36	2	54389
54800	5010 130 671	W 1" 14G	265	SW 38	2	54391-54392
54034	5000 815 754	M30x3.5	205	SW 46	2	54386
54036	5003 101 607	M20x1.5	170	SW 30	2	53722
54037	5003 101 520	M12x1.25	120	SW 19	2	53722
54038	5003 101 591	M16x1.5	170	SW 24	2	53724
54039	5010 294 518	M30x2	240	SW 46	2	53726-53730
54040	5003 101 417	M20x2.5	190	SW 30	2	53727
54047	5003 101 526	M20x1.5	160	SW 30	2	53949-54061
54066	5010 130 738	M20x1.5	160	SW 30	2	55248



Auger Nr.	O.E.M. Nr.	A	B	C	Type	Repair Kit
53299	5003 034 262	M20x2.5	20	SW 30	1	53727
54053	5000 815 755	M30x3.5	30	SW 46	1	54386
54055	5003 034 274	M30x2	32.6	SW 46	1	53726-53730
55284	5003 034 261-5003 034 275	M20x1.5	20	SW 30	1	53949-54061
55290	5003 034 182	M24x2	27.1	SW 36	1	54389
54420	5003 065 085	ø36.5	ø5.3	-	2	53950-54061
55289	5003 032 113	M20x1.5	18	SW 30	3	54388
55291	5010 130 669	W 1" 14G	22.5	SW 38	4	54391-54392
55283	5003 058 086	ø20.5	ø40	3	5	53949-54061-54388

Auger Nr.	OEM Nr.	Description	Model	Picture
53722	5000 448 405 S	Rep. Kit Spring Bolt Assembly ø20xø54x95	M140/160/200/230 MIDLINER GRANDE-BRETAGNE M/S 150/180/210/220/230TI/250 PS150/160 PA200/210 MIDLUM(FAB42B1/2-43C1/2-43T/V) MIDLUM EXPORT (FAB 43E1-43E2) MIDLUM 42B3/4-44T/V/C.-45D./E. MIDLUM 4X4 47XA/47XC MIDLUM CCF 4X4 (FAB 47XF) MIDLUM(FAB 42US-44US-45US)	
53724	5000 448 404 S	Rep. Kit Spring Bolt Assembly ø16xø43.5x95	M140/160/200/230 MIDLINER GRANDE-BRETAGNE M/S 150/180/210/220/230TI/250 PA200/210 MIDLUM(FAB42B1/2-43C1/2-43T/V) MIDLUM EXPORT (FAB 43E1-43E2) MIDLUM 42B3/4-44T/V/C.-45D./E. MIDLUM 4X4 47XA/47XC MIDLUM CCF 4X4 (FAB 47XF) MIDLUM(FAB 42US-44US-45US)	
53726	5010 052 741 S	Rep. Kit Spring Bolt Assembly ø30xø85x127	M140/160/200/230 AE380/385TI/420TI/500/520 MIDLINER GRANDE-BRETAGNE M/S 150/180/210/220/230TI/250 R 1993—> G220/270 BOM AE MAGNUM390/420TI/430/470/560	
53727	5010 052 742 S	Rep. Kit Spring Bolt Assembly ø65.5xø104.5x132.5	R310/330/340/365 1984—> M140/160/200/230 AE380/385TI/420TI/500/520 MIDLINER GRANDE-BRETAGNE R 1990—>1992 M/S 150/180/210/220/230TI/250 R 1993—> G220/270 BOM AE MAGNUM390/420TI/430/470/560	
53730	5001 852 218 S	Rep. Kit Spring Bolt Assembly ø30xø70x104	AE380/385TI/420TI/500/520 G340TI TR 18T PREMIUM TR 4X2 ==>1999 PREMIUM 6X2&6X2/4 ==>1999 AE MAGNUM390/420TI/430/470/560 PREMIUM PR 4X2 ==> 1999 KERAX ==> 1999 MAGNUM E-TECH 400/440/480 PREMIUM TR 4X2 2000 ==> PREMIUM(FAB22E/H/J/Q/R)2000==> PREMIUM PR 4X2 (FAB22A)2000==> KERAX FAB 33A==>S 2000==>2002 MIDLUM 42B3/4-44T/V/C.-45D./E. PREMIUM TRACTEUR 4X2(FAB 22CC) PREMIUM(FAB22EE/HA/HB/JJ/QQ/RR) PREMIUM PR 4X2 (FAB 22AA/AB) KERAX (FAB 33AA/././SS) PREMIUM 22C 071 ==> 1999	
54386	5000 815 738 S	Rep. Kit Spring Bolt Assembly ø30xø68x104	G260/290 R370/390/420 —>1989 R310/330/340/365 1984—> AE380/385TI/420TI/500/520 R 1990—>1992 R 1993—> G MANAGER 4X2 G MANAGER 6X2 & 6X4 AE MAGNUM390/420TI/430/470/560	

Auger Nr.	OEM Nr.	Description	Model	Picture
53949	5010 060 127 S	Rep. Kit Spring Bolt Assembly ø20xø44.5x104	G340TI TR 18T MAGNUM PREMIUM	
53950	5010 060 127 S1	Rep. Kit Spring Bolt Assembly ø20xø44.5x104	G260/290 G210/230 G320 G230/270 SP G220/270 BOM G200/210/230TI G MANAGER G340TI 6X6	
54061	5010 060 127 S2	Rep. Kit Spring Bolt Assembly ø20xø44.5x104	G340TI TR 18T MAGNUM PREMIUM	
54388	5010 066 115 S	Rep. Kit Spring Bolt Assembly ø21xø56.5x85	AE380/385TI/420TI/500/520 AE MAGNUM390/420TI/430/470/560	
54389	5010 066 116 S	Rep. Kit Spring Bolt Assembly ø25xø68.5x85	AE380/385TI/420TI/500/520 AE MAGNUM390/420TI/430/470/560	
55248	5010 130 738 S	Rep. Kit Spring Bolt Assembly M20x1.5/160	MAGNUM PREMIUM KERAX MAXTER	
54391	5010 130 652 S	Rep. Kit Spring Bolt Assembly ø63.5xø111x146	MAXTER 6X4 8X4 KERAX ==> 1999 KERAX FAB 33A==>S 2000==>2002 KERAX (FAB 33AA/././SS)	

Auger Nr.	OEM Nr.	Description	Model	Picture
54392	5010 130 652 S1	Rep. Kit Spring Bolt Assembly ø52.5xø63x94	MAXTER 6X4 8X4 KERAX ==> 1999 KERAX FAB 33A==>S 2000==>2002 KERAX (FAB 33AA//./SS)	 <p>54918 54800 55291</p>
54673	5010 064 737 S	Rep. Kit for Bogie Suspension ø105/ø106	CBH/CLM280/340 - R 1990-->1992 AE380/385TI/420TI/500/520 C230/280/300/340TI/CCH300 MAXTER 6X4 8X4 - CBH/CLM 320/385 R 1993--> - G MANAGER 6X2 & 6X4 AE MAGNUM390/420TI/430/470/560 KERAX ==> 1999 - G340TI 6X6 MAGNUM E-TECH 400/440/480 KERAX FAB 33A==>S 2000==>2002 KERAX (FAB 33AA//./SS) KERAX (FAB33A//./R) 2003==> KERAX 33G ARMEE BANGLADESH KERAX 33K ARMEE BANGLADESH	
54674	5010 064 735 S	Rep. Kit for Bogie Suspension ø118xø130x90	CBH/CLM280/340 - R 1990-->1992 AE380/385TI/420TI/500/520 C230/280/300/340TI/CCH300 MAXTER 6X4 8X4 - CBH/CLM 320/385 R 1993--> - G MANAGER 6X2 & 6X4 AE MAGNUM390/420TI/430/470/560 KERAX ==> 1999 - G340TI 6X6 MAGNUM E-TECH 400/440/480 KERAX FAB 33A==>S 2000==>2002 KERAX (FAB 33AA//./SS) KERAX (FAB33A//./R) 2003==> KERAX 33G ARMEE BANGLADESH KERAX 33K ARMEE BANGLADESH	 <p>54646 54661 54659</p>
54660	5010 064 735	Cradle ø118	CBH/CLM280/340 R 1990-->1992 MAXTER 6X4 8X4 CBH/CLM 320/385 R 1993--> G340TI 6X6 KERAX ==> 1999 KERAX FAB 33A==>S 2000==>2002 KERAX (FAB 33AA//./SS) KERAX (FAB33A//./R) 2003==> KERAX 33G ARMEE BANGLADESH KERAX 33K ARMEE BANGLADESH	
54659	0000 408 526	Bogie Suspension Bushing ø118xø130x90	GRH235/HF26 - GRH/TRH305 GRH/TRH350 - GBH/TBH280 1981--> GBH260/280 6X6 - GBH260/280 6X4 -->1980 G260/290 - C260/290 - F360 6X4->10/1983 R310 6X4 JSQ 8/1984 R370 JSQ 1984-R370/390/420 -->1989 R310/330/340/365 1984-> - CBH/CLM280/340 AE380/385TI/420TI/500/520 - R 1990-->1992 C230/280/300/340TI/CCH300 MAXTER 6X4 8X4 - CBH/CLM 320/385 R 1993--> - G MANAGER 6X2 & 6X4 G340TI 6X6 - AE MAGNUM390/420TI/430/470/560 MAGNUM E-TECH 400/440/480 - KERAX ==> 1999 KERAX FAB 33A==>S 2000==>2002 KERAX (FAB 33AA//./SS) KERAX (FAB33A//./R) 2003==> KERAX 33G ARMEE BANGLADESH	
54661	5010 229 070	Cap ø9/200x39	CBH/CLM280/340 - R 1990-->1992 AE380/385TI/420TI/500/520 C230/280/300/340TI/CCH300 MAXTER 6X4 8X4 - CBH/CLM 320/385 R 1993--> - G MANAGER 6X2 & 6X4 G340TI 6X6 - KERAX ==> 1999 AE MAGNUM390/420TI/430/470/560 MAGNUM E-TECH 400/440/480 - KERAX ==> 1999 KERAX FAB 33A==>S 2000==>2002 KERAX (FAB 33AA//./SS) KERAX (FAB33A//./R) 2003==> KERAX 33G ARMEE BANGLADESH KERAX 33K ARMEE BANGLADESH	
54646	0024 478 010	Expansion Jonit ø165xø222x40	GRH235/HF26 - GRH/TRH305 GRH/TRH350 - GBH/TBH280 1981--> GBH260/280 6X6 - GBH260/280 6X4 -->1980 G260/290 - C260/290 - F360 6X4->10/1983 R310 6X4 JSQ 8/1984 - R370 JSQ 1984 R370/390/420 -->1989 - R310/330/340/365 1984-> CBH/CLM280/340 - AE380/385TI/420TI/500/520 R 1990-->1992 - C230/280/300/340TI/CCH300 MAXTER 6X4 8X4 - CBH/CLM 320/385 R 1993--> - G MANAGER 6X2 & 6X4 G340TI 6X6 - AE MAGNUM390/420TI/430/470/560 MAGNUM E-TECH 400/440/480 - KERAX ==> 1999 KERAX FAB 33A==>S 2000==>2002 KERAX (FAB 33AA//./SS) - KERAX (FAB33A//./R) 2003-> - KERAX 33G ARMEE BANGLADESH	

Auger Nr.	OEM Nr.	Description	Model	Picture	
52063	5010 316 016	Buffer for Cabin ø25.5xø70.5x10	PREMIUM TR 4X2 ==>1999 PREMIUM 6X2&6X2/4 ==>1999 PREMIUM PR 4X2 ==> 1999 KERAX ==> 1999 - PREMIUM TR 4X2 2000 ==> PREMIUM(FAB22E/ H/ J/ Q/ R) 2000==> PREMIUM PR 4X2 (FAB22A)2000==> KERAX FAB 33A==>S 2000==>2002 PREMIUM TRACTEUR 4X2(FAB 22CC) PREMIUM(FAB22EE/ HA/ HB/ JJ/ QQ/ RR) PREMIUM PR 4X2 (FAB 22AA/AB) KERAX (FAB 33AA/././SS) KERAX (FAB33A/./R) 2003==> PREMIUM DXI 11 -FAB-27JC/TC PREMIUM DXI 11 -FAB-27RC/SC SISU - PREMIUM 22C 071 ==> 1999 KERAX 33K ARMEE BANGLADESH		
54369	0000 707 526	Buffer for Cabin M10x46	GR/TR280		
54371	0000 707 650	Buffer for Cabin M8/70x80x16.5	GR/TR280		
55169	5000 788 113	Buffer for Cabin M8/ø50x66.5	R310 4X2 -->8/84 R360 4X2 R360 6X4 --->10/1983 R310 6X4 JSQ 8/1984 R370 JSQ 1984 R370/390/420 --->1989 R310/330/340/365 1984---> R 1990--->1992 R 1993--->		
51698	5010 239 669	Cabin Bushing ø64xø68x21.5	PREMIUM PR 4X2 ==> 1999 KERAX ==> 1999 PREMIUM 260 SP PREMIUM 260 SP KERAX FAB 33A==>S 2000==>2002 KERAX (FAB 33AA/././SS) KERAX (FAB33A/./R) 2003==>		
51699	5010 228 947	Cabin Mounting ø30xø68x49	PREMIUM PR 4X2 ==> 1999 KERAX ==> 1999 PREMIUM 260 SP PREMIUM 260 SP KERAX FAB 33A==>S 2000==>2002 KERAX (FAB 33AA/././SS) KERAX (FAB33A/./R) 2003==>		
52010	5000 419 186	Cabin Mounting ø20xø58x81	JE13/15 - G260/290 JN55/60/85 - JP11/13 JK55/60/65/75 JR/JX19/21 S170 (FAB-SH) G170 - G210/230 S130/150TI (VF6JN) S130/150TI/170 (VF6JP) J35/48/55/60 S110/130 (VF6JK) S100 - G320 M140/160/200/230 MIDLINER GRANDE BRETAGNE S140/160 M/S 4X4 & INCENDIE ME/SE/CE/160/180/210	MAXTER 6X4 8X4 M/S150/180/210/220/230 TI250 G230/270 SP S120/135 G220/270 BOM G200/210/230TI G MANAGER 4X2 G MANAGER 6X2&6X4 G340TI 6X6 G340TI 4X4 MAXTER 4X2-4X4 S135/150 (MOT 040226) M210 4X4 MS300 SUDAMERICA MACK MS200/250/300 1990-->	





Auger Nr.	OEM Nr.	Description	Model	Picture
52013	5010 418 820	Cabin Mounting ø16xø38x90	AE380/385TI/420TI/500/520 AE MAGNUM390/420TI/430/470/560 MAGNUM E-TECH 400/440/480	
52014	5010 273 535	Cabin Mounting ø16.5xø50x80	AE380/385TI/420TI/500/520 AE MAGNUM390/420TI/430/470/560 MAGNUM E-TECH 400/440/480	
52057	5001 852 865	Cabin Mounting ø28xø38x40	AE380/385TI/420TI/500/520	
52065	5010 211 939	Cabin Mounting M18/38.5	AE380/385TI/420TI/500/520 AE MAGNUM390/420TI/430/470/560 MAGNUM E-TECH 400/440/480	
53600	5010 316 015	Cabin Mounting ø16xø60.5x68	PREMIUM TR 4X2 ==>1999 PREMIUM 6X2&6X2/4 ==>1999 PREMIUM PR 4X2 ==> 1999 KERAX ==> 1999 PREMIUM TR 4X2 2000 ==> PREMIUM(FAB22E/ H/ J/ Q/ R) 2000==> PREMIUM PR 4X2 (FAB22A)2000==> KERAX FAB 33A==>S 2000==>2002 MIDLUM 42B3/4-44TA/C.-45D/E PREMIUM(FAB22EE/ HA/ HB/ JJ/ QQ/ RR PREMIUM PR 4X2 (FAB 22AA/AB) KERAX (FAB 33AA/././SS) SISU - PREMIUM 22C 071 ==> 1999	
53608	5010 269 380	Cabin Mounting ø12xø40x41.5	PREMIUM TR 4X2 ==>1999 PREMIUM 6X2&6X2/4 ==>1999 PREMIUM PR 4X2 ==> 1999 KERAX ==> 1999 PREMIUM 260 SP PREMIUM TR 4X2 2000 ==> PREMIUM(FAB22E/ H/ J/ Q/ R) 2000==> PREMIUM PR 4X2 (FAB22A)2000==> KERAX FAB 33A==>S 2000==>2002 PREMIUM(FAB22EE/ HA/ HB/ JJ/ QQ/ PREMIUM PR 4X2 (FAB 22AA/AB) KERAX (FAB 33AA/././SS) KERAX (FAB33A/././R) 2003==> SISU PREMIUM 22C 071 ==> 1999	
53609	5000 789 265	Cabin Mounting ø12xø40x42	PREMIUM TR 4X2 ==>1999 PREMIUM 6X2&6X2/4 ==>1999 PREMIUM PR 4X2 ==> 1999 KERAX ==> 1999 PREMIUM 260 SP PREMIUM TR 4X2 2000 ==> PREMIUM(FAB22E/ H/ J/ Q/ R) 2000==> PREMIUM PR 4X2 (FAB22A)2000==> KERAX FAB 33A==>S 2000==>2002 PREMIUM(FAB22EE/ HA/ HB/ JJ/ QQ/ PREMIUM PR 4X2 (FAB 22AA/AB) KERAX (FAB 33AA/././SS) KERAX (FAB33A/././R) 2003==> SISU PREMIUM 22C 071 ==> 1999	

Auger Nr.	OEM Nr.	Description	Model	Picture
53667	5001 844 625	Cabin Mounting ø14xø42.5x60	AE380/385TI/420TI/500/520 AE MAGNUM390/420TI/430/470/560 MAGNUM E-TECH 400/440/480	
53669	5010 418 819	Cabin Mounting ø14xø27x45	AE380/385TI/420TI/500/520 AE MAGNUM390/420TI/430/470/560 MAGNUM E-TECH 400/440/480	
53674	5010 130 430	Cabin Mounting ø18xø48x68.5	R 1993—>	
54303	5010 552 347	Cabin Mounting ø20xø48x42	PREMIUM DXI 11-FAB-27JC/TC PREMIUM DXI 11-FAB-27RC/SC	
54354	5010 552 346	Cabin Mounting ø20xø65x55	PREMIUM DXI 11-FAB-27JC/TC PREMIUM DXI 11-FAB-27RC/SC	
54382	5000 789 681	Cabin Mounting ø16x90x54/50 Shore A	---	
54383	---	Cabin Mounting ø16x90x54/70 Shore A	---	







Auger Nr.	OEM Nr.	Description	Model	Picture
55171	5010 460 097	Cabin Mounting ø16.5xø92x80	MIDLUM(FAB42B1/2-43C1/2-43T/V) MIDLUM EXPORT (FAB 43E1-43E2) MIDLUM 42B3/4-44T/V/C.-45D./E. MIDLUM 4X4 47XA/47XC MIDLUM CCF 4X4 (FAB 47XF) MIDLUM(FAB 42US-44US-45US)	
55173	0023 535 339	Cabin Mounting ø28xø48x55	TR/GR305 - TR/GR350 GR/TR280 - GRH/TRH305 GRH/TRH350 - R310 4X2 -->8/84 R360 4X2 - R360 6X4->10/1983 R310 6X4 JSQ 8/1984 R370 JSQ 1984 R370/390/420->1989 310/330/340/365 1984---> R 1990--->1992 - R 1993--->	
54370	0000 703 308	Cabin Mounting ø16/ø25.5xø56x52	---	
52064	5010 211 938	Rubber Dust Cover for Cabin ø30xø46x28.5	AE380/385TI/420TI/500/520 AE MAGNUM390/420TI/430/470/560 MAGNUM E-TECH 400/440/480	
52017	5010 060 298	Cabin Bushing ø16xø28x80	AE380/385TI/420TI/500/520	
54304	5010 610 378	Bolt for Cabin ø20.5x170	PREMIUM DXI 11-FAB-27JC/TC PREMIUM DXI 11-FAB-27RC/SC	
54355	5010 552 020	Bolt for Cabin ø20.5x210	PREMIUM DXI 11-FAB-27JC/TC PREMIUM DXI 11-FAB-27RC/SC	



Auger Nr.	O.E.M. Nr.	A	B	C	Type	Repair Kit
54910	5010 460 046	ø28	ø32	30	1	53739
55292	5000 788 532	ø30	ø34	20	1	55175
55293	5000 788 531 - 0948 570 409	ø70	ø75	60	1	55174
54879	5010 439 195 - 5000 788 257	ø49	ø58	4	2	55175
55274	5800 207 873	ø50	ø75	35	3	55175
55290	5003 034 182	M24x2	27.1	SW 36	4	55175

Auger Nr.	OEM Nr.	Description	Model	Picture
53725	---	Rep. Kit for Cabin ø12xø40x42	PREMIUM TR 4X2 ==>1999 PREMIUM 6X2&6X2/4 ==>1999 PREMIUM PR 4X2 ==> 1999 KERAX ==> 1999 - PREMIUM 260 SP PREMIUM TR 4X2 2000 ==> PREMIUM(FAB22E/ H/ J/ Q/ R) 2000==> PREMIUM PR 4X2 (FAB22A)2000==> KERAX FAB 33A==>S 2000==>2002 PREMIUM TRACTEUR 4X2(FAB 22CC) PREMIUM(FAB22EE/ HA/ HB/ JJ/ QQ/ RR PREMIUM PR 4X2 (FAB 22AA/AB) KERAX (FAB 33AA/././SS) KERAX (FAB33A/./R) 2003==> SISU-PREMIUM 22C 071 ==> 1999 KERAX 33G ARMEE BANGLADESH KERAX 33K ARMEE BANGLADESH	
53728	5010 316 015 S	Rep. Kit for Cabin ø16xø60.5x68	PREMIUM TR 4X2 ==>1999 PREMIUM 6X2&6X2/4 ==>1999 PREMIUM PR 4X2 ==> 1999 KERAX ==> 1999 PREMIUM TR 4X2 2000 ==> PREMIUM(FAB22E/ H/ J/ Q/ R) 2000==> PREMIUM PR 4X2 (FAB22A)2000==> KERAX FAB 33A==>S 2000==>2002 PREMIUM TRACTEUR 4X2(FAB 22CC) PREMIUM(FAB22EE/ HA/ HB/ JJ/ QQ PREMIUM PR 4X2 (FAB 22AA/AB) KERAX (FAB 33AA/././SS) PREMIUM 22C 071 ==> 1999 SISU	
54387	5010 228 947 S	Rep. Kit for Cabin ø30xø68x49	PREMIUM PR 4X2 ==> 1999 KERAX ==> 1999 PREMIUM 260 SP PREMIUM 260 SP KERAX FAB 33A==>S 2000==>2002 KERAX (FAB 33AA/././SS) KERAX (FAB33A/./R) 2003==> KERAX 33G ARMEE BANGLADESH	
55174	5000736614 S	Rep. Kit for Cabin ø28xø48x55	R310 4X2 -->8/84 R360 4X2 R360 6X4 --->10/1983 R310 6X4 JSQ 8/1984 R370 JSQ 1984 R370/390/420 --->1989 R310/330/340/365 1984---> R 1990--->1992 R 1993--->	



Auger Nr.	OEM Nr.	Description	Model	Picture
55175	5000 736 588 S	Rep. Kit for Cabin ø50xø75x28/35	R310 4X2 -->8/84 R360 4X2 R360 6X4 --->10/1983 R310 6X4 JSQ 8/1984 R370 JSQ 1984 R370/390/420 ---->1989 R310/330/340/365 1984---> R 1990--->1992 R 1993--->	 <p>55274 55290 54879 55292</p>
53739	5010 228 902 S	Rep. Kit for Cabin ø28xø32x30	KERAX ==> 1999 KERAX FAB 33A==>S 2000==>2002 KERAX (FAB 33AA/././SS) KERAX (FAB33A/./R) 2003==>	 <p>54910</p>
20053	5010 130 797 5010 629 414	Air Bellows for Cabin L: 125	PREMIUM KERAX SISU	
20054	5010 320 096	Air Bellows for Cabin L: 265	MAGNUM	
20055	5010 092 916	Air Bellows for Cabin L: 115	G MANAGER 4X2 G MANAGER 6X2 & 6X4 G340TI TR 18T	
20056	5010 266 845 5010 313 619	Air Bellows for Cabin L: 115	G MANAGER 4X2 G MANAGER 6X2 & 6X4 G340TI TR 18T	

Auger Nr.	OEM Nr.	Description	Model	Picture
20071	5010 133 079	Air Bellows for Cabin L: 92	MAXTER 6X4 8X4 G220/270 BOM G200/210/230TI G MANAGER 4X2 G MANAGER 6X2 & 6X4 G340TI 6X6 G340TI 4X4 MAXTER 4X2-4X4	
20057	5010 228 908 5010 269 674 5010 316 783	Cabin Shock Absorber, With Air Bellow ø12xø38	PREMIUM KERAX SISU	
20105	5010 228 849	Cabin Shock Absorber, With Air Bellow ø45	MAGNUM E-TECH	
20106	5010 615 879	Cabin Shock Absorber, With Air Bellow ø12xø45	PREMIUM	
20107	7482 052 893 7420 898 055 5010 552 241	Cabin Shock Absorber, With Air Bellow ø45	PREMIUM MAGNUM KERAX	
20096	5010 491 301	Air Bellows for Cabin L: 310	MAGNUM	

Auger Nr.	OEM Nr.	Description	Model	Picture
20115	5010 629 785	Air Bellows for Cabin L: 140	PREMIUM KERAX	
20086	5010 269 605 5010 269 605 5010 460 113	Shock Absorber For Cabin	Premium Front Connection: O / O	
20087	5000 741 014 5010 130 535 5010 460 114	Shock Absorber For Cabin C/O L. 205 / 292	Magnum AE / E TECH Connection: I / I	
20088	5000 741 013 5010 130 534 5010 137 139 5010 460 115	Shock Absorber For Cabin C/O L. 248 / 365	Magnum AE / E TECH Front Connection: O / I	
20089	5010 370 630 5010 460 116	Shock Absorber For Cabin C/O L. 253 / 385	Magnum AE / E TECH Front Connection: O / O	
53618	5000 471 623	Buffer for Cabin M14/ø80x66	GB131/ HR15 GB/ TB191/ 231 GC191/ 231 GR191/ 231 GRH235/ HF26 TF231D GF151D JE13/ 15 MAXTER 6X4 8X4 G220/270 BOM G200/ 210/ 230TI G MANAGER 4X2 G340TI 6X6 G340TI 4X4 MAXTER 4X2-4X4 S135/150 (MOT 040226) M210 4X4	
54645	5010 316 874	Buffer for Cabin ø90/ø98x143/163	Kerax Premium Sisu	

Auger Nr.	OEM Nr.	Description	Model	Picture
53664	5010 228 902	Cabin Bracket ø28	PREMIUM TR 4X2 ==>1999 PREMIUM 6X2&6X2/4 ==>1999 PREMIUM PR 4X2 ==> 1999 KERAX ==> 1999 PREMIUM TR 4X2 2000 ==> PREMIUM(FAB22E/H/J/Q/R)2000==> PREMIUM PR 4X2 (FAB22A)2000==> KERAX FAB 33A==>S 2000==>2002 PREMIUM TRACTEUR 4X2(FAB 22CC) PREMIUM(FAB22EE/HA/HB/JJ/QQ/RR) PREMIUM PR 4X2 (FAB 22AA/AB) KERAX (FAB 33AA/././SS) KERAX (FAB33A/././R) 2003==> SISU - KERAX 33K ARMEE BANGLADESH	
54287	5010 228 956	Cabin Bracket ø30	PREMIUM PR 4x2 ==> KERAX==>1999 PREMIUM 260 SP KERAX FAB 33A==>S 2000==>2002 KERAX (FAB 33AA/././SS) KERAX(FAB33A/././R) 2003==> KERAX 33G ARMEE BANGLADESH	
54305	5010 552 266	Cabin Bracket ø16	KERAX (FAB33A/././R) 2003==> PREMIUM DXI 11-FAB-27JC/TC PREMIUM DXI 11-FAB-27RC/SC	
54306	5010 552 267	Cabin Bracket ø16	MAGNUM DXI 12-VAR-120AV	
54307	5010 552 268	Cabin Bracket 125x190x178	MAGNUM DXI 12-VAR-120AV	
55170	5010 316 479	Cabin Bracket ø16.5	MIDLUM(FAB42B1/2-43C1/2-43T/V) MIDLUM EXPORT (FAB 43E1-43E2) MIDLUM 42B3/4-44T/V/C.-45D./E. MIDLUM 4X4 47XA/47XC MIDLUM CCF 4X4 (FAB 47XF) MIDLUM(FAB 42US-44US-45US)	
55172	0000 707 904	Cabin Bracket M14/ø28	TR/GR305 TR/GR350 GR/TR280 GRH/TRH305 GRH/TRH350 R310 4X2 -->8/84 R360 4X2 R360 6X4 --->10/1983 R310 6X4 JSQ 8/1984	

Auger Nr.	OEM Nr.	Description	Model	Picture
52028	0000 790 899	Stabilizer Bushing ø43xø61x32	TR/GR305 - TR/GR350 GR191/231 - GR/TR280 R310 4X2 ->8/84 R360 4X2 GLC/CLR190/230 G260/290 - C260/290 GLM/TLM280 GLR230 4X4 SINPAR C210/CLR220 G210/230 R370 JSC 1984 R370/390/420 ->1989 R310/330/340/365 1984-> CBH/CLM280/340 G320 - R1990->1992 C230/280/300/340TV/C CH300-CBH/CLM 320/385 R 1993-> G220/270 BOM G200/210/230TI G MANAGER 4X2 G MANAGER 6X2 & 6X4 - G340TI 4X4 MAXTER 4X2-4X4 KERAX => 1999 KERAX FAB 33A=>S 2000=>2002 KERAX (FAB 33AA//SS) KERAX (FAB33A//R) 2003=>	
52029	5010 239 670	Stabilizer Bushing ø42xø60.5x26	AE380/ 385TV/ 420TV/ 500/ 520 PREMIUM TR 4X2 =>1999 PREMIUM 6X2&6X2/4 =>1999 AE MAGNUM390/420TI/430/470/560 PREMIUM PR 4X2 => 1999 KERAX => 1999 MAGNUM E-TECH 400/440/480 PREMIUM TR 4X2 2000 => PREMIUM (FAB22E/ H/ J/ Q/ R) 2000=> PREMIUM PR 4X2 (FAB22A)2000=> KERAX FAB 33A=>S 2000=>2002 PREMIUM TRACTEUR 4X2(FAB 22CC) PREMIUM (FAB22EE/ HA/ HB/ JJ/ QQ/ RR PREMIUM PR 4X2 (FAB 22AA/AB) KERAX (FAB 33AA//SS) MAGNUM DXI 12 -VAR-120AV PREMIUM DXI 11 -FAB-27JC/TC PREMIUM DXI 11 -FAB-27RC/SC PREMIUM 22C 071 => 1999	
52030	5010 294 991	Stabilizer Bushing ø30xø42x19	G340TI TR 18T PREMIUM TR 4X2 =>1999 PREMIUM 6X2&6X2/4 =>1999 AE MAGNUM390/420TI/430/470/560 PREMIUM PR 4X2 => 1999 PREMIUM 260 SP	
52061	5001 851 533 S	Stabilizer Bushing ø14xø42x21	PREMIUM TR 4X2 PREMIUM 6X2&6X2/4 AE MAGNUM390/420TI/430/470/560 PREMIUM PR 4X2	
52877	5000 719 742	Stabilizer Bushing ø29xø44.5x28.5	GB131/HR15 GB/TB191/231 GC191/231 PGC191/231 G260/290 G170 G210/230 G320 G230/270 SP G200/210/230TI G MANAGER 4X2	
54343	5010 304 948	Stabilizer Bushing ø42xø56x25	MAXTER 6X4 8X4 KERAX => 1999 KERAX FAB 33A=>S 2000=>2002 KERAX (FAB 33AA//SS) KERAX (FAB33A//R) 2003=> KERAX 33G ARMEE BANGLADESH KERAX 33K ARMEE BANGLADESH	



Auger Nr.	OEM Nr.	Description	Model	Picture	
54366	0000 754 160	Stabilizer Bushing ø30xø45.5x31	TF231D GLC/GLR190/230		
51098	5010 304 950	Stabilizer Plastic Bearing ø50.5xø86x63	MAXTER 6X4 8X4 KERAX ==> 1999 KERAX FAB 33A==>S 2000==>2002 KERAX (FAB 33AA/././SS) KERAX (FAB33A/././R) 2003==> KERAX 33G ARMEE BANGLADESH KERAX 33K ARMEE BANGLADESH		
51394	5000 279 225	Stabilizer Plastic Bearing ø38xø58x74	---		
52022	0000 716 243	Stabilizer Plastic Bearing ø38x32	TR/GR305 TR/GR350 GR/TR280 GRH/TRH305 GRH/TRH350 R310 4X2 ->8/84 R360 4X2 R360 6X4 -> 10/1983	R310 6X4 JSQ 8/1984 R370 JSQ 1984 R370/390/420 - >1989 R310/330/340/365 1984-> R 1990->1992 R 1993->	
52023	0000 716 242	Stabilizer Plastic Bearing ø41x32	TR/GR305 TR/GR350 GR/TR280 GRH/TRH305 GRH/TRH350 R310 4X2 ->8/84 R360 4X2 R360 6X4 -> 10/1983	R310 6X4 JSQ 8/1984 R370 JSQ 1984 R370/390/420 - >1989 R310/330/340/365 1984-> R 1990->1992 R 1993->	
52024	0000 714 814	Stabilizer Plastic Bearing ø34x37	GC191/ 231 GR191/ 231 GRH235/ HF26 TF231D GF151D PGC191/ 231 GLC/ GLR190/ 230 G260/ 290 C260/ 290 GLR230 4X4 SIN- PAR C210/ CLR220 G170	G210/ 230 G320 C230/ 280/ 300/ 340TI/ CCH300 G230/270 SP G220/270 BOM G200/ 210/ 230TI G MANAGER 4X2 G MANAGER 6X2 & 6X4 G340TI 4X4 PG230/ 280	
53652	0000 707 792	Stabilizer Plastic Bearing ø50x42.5	TR/GR305 TR/GR350 GR191/231 GR/TR280 R310 4X2 ->8/84 R360 4X2 GLC/GLR190/230 C260/290 GLR230 4X4 SINPAR C210/CLR220		







Auger Nr.	OEM Nr.	Description	Model	Picture	
52025	5000 352 492	Stabilizer Plastic Bearing ø39.5xø53.5x80	PJK/PJN/PJP - JE13/15 JN55/60/85 - JP11/13 JR/JX19/21 - S170 (FAB=SH) S130/150TI (VF6JN) S130/150TI/170 (VF6JP) S100 - M140/160/200/230 MIDLINER GRANDE-BRETAGNE S140/160 M/S 4X4 & INCENDIE M/S 150/180/210/220/230TI/250 PS150/160 - S120/135 MACK MS200/250/300 1990-->		
52027	5000 464 786	Stabilizer Plastic Bearing ø49xø63.5x76	---		
52054	0000 714 088	Stabilizer Plastic Bearing ø25.5xø44.5x49.5	TRV/GR905/350 GB131/HR15 GB/IB191/231 GC191/231-GR191/231 GH425/HF25 GRV/TR880 GRH/TR805/350 TR231D - GF151D R310/360 4X2 -8/84 PJK/PJN/PJP PGC191/231 GLC/GLR190/230 R360 6X4 -> 10/1983 R310 6X4 -> 8/1984 GLP230 4X4 SINPAB C210/260/290 CLP220 G170/210/230/260/290/ 320-S130/150TI (VF6JN)- R370 JSO 1984 R370/390/420 ->1999 R310/330/340/365 1984-> CBH/CLM280/340 AE380/385TV 420TI/500/	520 - R1990->1992 C230/280/300/340TI/ CCH190-MAXTER 6X4 8X4 CBH/CLM 320/385 R1993->G230/270 SP G220/270 BOM G200/210/230TI GMANAGER 4X2 & 6X2 & 6X4 - G340TI 4X4 MAXTER 4X2-4X4 AE MAGNUM390/420TI/ 430/470/560-KERAX=>1999 PG230/280 KERAX FAB 33A=>S 2000->2002 KERAX (FAB 33AA//SS) KERAX (FAB33A//R) 2003-> KERAX 33G/K ARMEE	
52055	5010 066 937	Stabilizer Plastic Bearing ø53xø76x76	AE380/385TI/420TI/500/520 G340TI TR 18T PREMIUM TR 4X2 ==>1999 AE MAGNUM390/420TI/430/470/560 PREMIUM PR 4X2 ==> 1999 PREMIUM 260 SP PG230/280 PREMIUM TR 4X2 2000 ==> PREMIUM PR 4X2 (FAB22A)2000==> PREMIUM TRACTEUR 4X2(FAB 22CC) PREMIUM PR 4X2 (FAB 22AA/AB) PREMIUM 22C 071 ==> 1999		
52062	5010 066 936	Stabilizer Plastic Bearing ø41x38	AE380/385TI/420TI/500/520 G340TI TR 18T PREMIUM TR 4X2 ==>1999 AE MAGNUM390/420TI/430/470/560 PREMIUM PR 4X2 ==> 1999 PREMIUM 260 SP PG230/280 PREMIUM TR 4X2 2000 ==> PREMIUM PR 4X2 (FAB22A)2000==> PREMIUM TRACTEUR 4X2(FAB 22CC) PREMIUM PR 4X2 (FAB 22AA/AB) PREMIUM 22C 071 ==> 1999		
52878	5000 464 785	Stabilizer Plastic Bearing ø54.5xø64x76	M140/160/200/230 M/S 150/180/210/220/230TI/250 PA200/210 MIDLUM(FAB42B1/2-43C1/2-43T/V) MIDLUM 42B3/4-44T/V/C.-45D./E. MIDLUM(FAB 42US-44US-45US)		

Auger Nr.	OEM Nr.	Description	Model	Picture
53224	5010 557 313	Stabilizer Plastic Bearing ø50xø64.5x76.5	R310/360 4X2 ->8/84 - PJK/ P/JN/ PJP JE13/ 15 - G210/220/230/260/290/320/270 BOM C260/290 / C210/CLR220 - JP11/ 13 JK55/ 60/ 65/ 75 - JR/ JX19/ 21 S170 (FAB=SH) - GLM/ TLM280 J & S 4X4 ->6/1991 - S130/150TI (VF6JN)/170 (VF6JP) R370 JSQ 1984 - R370/390/420->1989 R310/330/340/365 1984-> S110/130 (VF6JK) S100/ 120/ 135/ 140/ 160 - CBH/ CLM280/ 340 - M140/ 160/ 200/ 230 - MIDLINER GRANDE-BRETAGNE R 1990->1992 - C230/ 280/ 300/ 340TI/ CCH300 - ME/SE/CE/ 160/180/210 - CBH/CLM 320/365 - MS 150/180/210/220/230TI/250-PS150/ 160 - R 1993-> G200/ 210/ 230TI - G MANAGER 4X2 & 6X2 & 6X4 - G340TI 4X4 - MAXTER 4X2-4X4 - M210 4X4 - KERAX => 1999 PA200/ 210 - MIDLUM(FAB42B1/ 2- 43C1/ 2- 43T/ V) KERAX FAB 33A=>S 2000=>2002 MIDLUM 42B3/4-44TV/C.-45D./E.-MIDLUM 4X4 47XA47XC KERAX (FAB 33AA/././SS)-KERAX (FAB33A/./R) 2003=> MIDLUM CCF 4X4 (FAB 47XF)-MACK MS200/250/300 1990->	
53225	5010 557 314	Stabilizer Plastic Bearing ø38xø64.5x76.5	MIDLUM(FAB42B1/2-43C1/2-43T/V) MIDLUM EXPORT (FAB 43E1-43E2) MIDLUM 42B3/4-44TV/C.-45D./E. MIDLUM (FAB 42US-44US-45US)	
53601	5010 557 315	Stabilizer Plastic Bearing ø38.5xø58.5x73	R310 4X2 ->8/84 - R360 4X2 -PJK/ P/JN/ PJP - JE13/ 15 G260/ 290 - C260/ 290 - JP11/ 13 - JK55/ 60/ 65/ 75 JR/ JX19/ 21 - S170 (FAB=SH) - GLM/ TLM280 J & S 4X4 ->6/1991 - C210/ CLR220 - G170 G210/ 230 -S130/150TI (VF6JN) - S130/150TI/170 (VF6JP) R370 JSQ 1984 - R370/390/420 ->1989 - R310/330/340/365 1984-> - S110/130 (VF6JK) - S100 - CBH/ CLM280/ 340 -G320 M140/ 160/ 200/ 230 - MIDLINER GRANDE-BRETAGNE R 1990->1992 - S140/ 160 - C230/ 280/ 300/ 340TI/ CCH300 - MS 4X4 & INCENDIE - ME/SE/CE/ 160/180/210 CBH/CLM 320/365 - MS 150/180/210/220/230TI/250 PS150/ 180 - R 1993-> - G230/270 SP - S120/ 135 G220/270 BOM - G200/ 210/ 230TI - G MANAGER 4X2 G MANAGER 6X2 & 6X4 - G340TI 4X4-MAXTER 4X2-4X4 M210 4X4 - KERAX=>1999 - MIDLUM(FAB42B1/ 2- 43C1/ 2- 43T/ V)-MIDLUM EXPORT (FAB 43E1-43E2) - KERAX FAB 33A=>S 2000=>2002 MIDLUM 42B3/4-44TV/C.-45D./E. - MIDLUM 4X4 47XA47XC KERAX (FAB 33AA/././SS)-KERAX (FAB33A/./R) 2003=> MIDLUM CCF 4X4 (FAB 47XF)-MACK CS200/250/300 1990-> -MIDLUM(FAB 42US-44US-45US)	
53651	0000 707 791	Stabilizer Plastic Bearing ø42.5xø56x69	TR/GR305 TR/GR350 GR191/231 GR/TR280 R310 4X2 ->8/84 R360 4X2 GLC/GLR190/230 C260/290 GLR230 4X4 SINPAR C210/CLR220	
53672	5010 557 312	Stabilizer Plastic Bearing ø55xø64.5x76.5	M140/160/200/230 M/S 150/180/210/220/230TI/250 PA200/210 MIDLUM(FAB42B1/2-43C1/2-43T/V) MIDLUM 42B3/4-44TV/C.-45D./E. MIDLUM(FAB 42US-44US-45US)	
55507	5000 725 147	Stabilizer Plastic Bearing ø44.5x59	G260/290 12 - 1989 G170 03 - 1990 G210/230 09 - 1990 G320 12 - 1989 G230/270 SP 12 - 1995 G200/210/230TI 12 - 1997 G MANAGER 4X2	

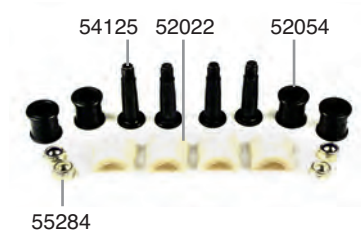

Auger Nr.	O.E.M. Nr.	A	B	C	Type	Repair Kit
52015	5010 239 135	ø20	ø30	41	1	-
52016	5010 239 674	ø20	ø42	56.5	1	-
52018	0000 790 871	ø20	ø42	67	1	52043-52049-52052
54342	0000 487 790	ø28	116	-	2	-
54125	0000 714 089	M20x1.5	101.5	ø26.5	3	52039-52040-52044-52046-52053
55224	5000 297 191	M20x1.5	108.5	ø26.5	3	52038-52041-52045-52047
54790	5010 497 724	ø12	86.5	ø41.8	4	54390
54798	5003 101 582	M20x1.5	130	SW 30	5	54393-54394
55284	5003 034 261 5003 034 275 5003 034 260	M20x1.5	20	SW 30	6	52037-52043-52049-52052-54393-54394 52044-52045-52046-52047 52039-52040-52041-52053-52038

Auger Nr.	OEM Nr.	Description	Model	Picture
52037	5001 851 533	Stabilizer Bearing Kit ø14xø42x21	PREMIUM TR 4X2 PREMIUM 6X2&6X2/4 AE MAGNUM390/420TI/430/470/560 PREMIUM PR 4X2	
52038	0000 714 088 S1	Stabilizer Bearing Kit M20x1.5/108.5	TR/ GR305 - TR/ GR350 GR/ TR280 - GRH/ TRH305 GRH/ TRH350 - R310 4X2 ->8/84 R360 4X2 - R360 6X4 -> 10/1983 R310 6X4 JSQ 8/1984 -R370 JSQ 1984 R370/390/420 ->1989 R310/330/340/365 1984-> R 1990->1992 - R 1993->	
52039	---	Stabilizer Bearing Kit M20x1.5/101.5	GC191/ 231 GR191/ 231 GRH235/ HF26 TF231D GF151D PGC191/ 231 GLC/ GLR190/ 230 G260/ 290 C260/ 290 GLR230 4X4 SIN- PAR C210/ CLR220	

Auger Nr.	OEM Nr.	Description	Model	Picture
52040	---	Stabilizer Bearing Kit M20x1.5/101.5	TR/ GR305 - TR/ GR350 GR/ TR280 - GRH/ TRH305 GRH/ TRH350 - R310 4X2 ->8/84 R360 4X2 - R360 6X4 -> 10/1983 R310 6X4 JSQ 8/1984 R370 JSQ 1984 R370/390/420 ->1989 R310/330/340/365 1984-> R 1990->1992 - R 1993->	
52041	---	Stabilizer Bearing Kit M20x1.5/108.5	TR/ GR305 TR/ GR350 GR/ TR280 GRH/ TRH305 GRH/ TRH350 R310 4X2 ->8/84 R360 4X2 R360 6X4 -> 10/1983 R310 6X4 JSQ 8/1984 R370 JSQ 1984 R370/390/420 ->1989 R310/330/340/365 1984-> R 1990->1992 R 1993->	
52042	---	Stabilizer Bearing Kit	AE380/385TI/420TI/500/520 G340TI TR 18T PREMIUM TR 4X2 ==>1999 AE MAGNUM390/420TI/430/470/560 PREMIUM PR 4X2 ==> 1999 PREMIUM 260 SP PG230/280 PREMIUM TR 4X2 2000 ==> PREMIUM PR 4X2 (FAB22A)2000==> PREMIUM TRACTEUR 4X2(FAB 22CC) PREMIUM PR 4X2 (FAB 22AA/AB) PREMIUM 22C 071 ==> 1999	
52043	---	Stabilizer Bearing Kit	R310 4X2->8/84 R360 4X2 G260/ 290 C260/ 290 GLM/ TLM280 C210/ CLR220 G210/ 230 R370 JSQ 1984 R370/390/420 ->1989 CBH/ CLM280/ 340 G320 C230/ 280/ 300/ 340TI/ CCH300 KERAX MAXTER	
52044	---	Stabilizer Bearing Kit M20x1.5x101.5	TR/GR305 TR/GR350 GRH/TRH305 GRH/TRH350 R310 4X2 ->8/84 R360 4X2 R360 6X4 -> 10/1983 R310 6X4 JSQ 8/1984 R370 JSQ 1984 R370/390/420 ->1989 R310/330/340/365 1984-> R 1990->1992 R 1993->	
52045	---	Stabilizer Bearing Kit M20x1.5/108.5	TR/GR305 TR/GR350 GRH/TRH305 GRH/TRH350 R310 4X2 ->8/84 R360 4X2 R360 6X4 -> 10/1983 R310 6X4 JSQ 8/1984 R370 JSQ 1984 R370/390/420 ->1989 R310/330/340/365 1984-> R 1990->1992 R 1993->	

Auger Nr.	OEM Nr.	Description	Model	Picture
52046	---	Stabilizer Bearing Kit M20x1.5/101.5	TR/GR305 TR/GR350 GR/TR280 GRH/TRH305 GRH/TRH350 R310 4X2 ->8/84 R360 4X2 R360 6X4 -> 10/1983 R310 6X4 JSQ 8/1984 R370 JSQ 1984 R370/390/420 ->1989 R310/330/340/365 1984-> R 1990->1992 R 1993->	
52047	---	Stabilizer Bearing Kit M20x1.5/108.5	TR/GR305 TR/GR350 GR/TR280 GRH/TRH305 GRH/TRH350 R310 4X2 ->8/84 R360 4X2 R360 6X4 -> 10/1983 R310 6X4 JSQ 8/1984 R370 JSQ 1984 R370/390/420 ->1989 R310/330/340/365 1984-> R 1990->1992 R 1993->	
52049	---	Stabilizer Bearing Kit	R310 4X2->8/84 R360 4X2 G260/ 290 C260/ 290 GLM/ TLM280 C210/ CLR220 G210/ 230 R370 JSQ 1984 R370/390/420->1989 R310/330/340/365 1984-> CBH/ CLM280/340 G320 R1990->1992 C230/ 280/ 300/ 340TI/ CCH300 CBH/CLM 320/385 R1993->	
54394	5010 557 130 S1 5010 557 129 S1 5000 434 716 S1	Stabilizer Bearing Kit ø20xø45x66	M140/ 160/ 200/ 230 MIDLINER GRANDE-BRETAGNE ME/ SE/ CE/ 160/ 180/ 210 M/S 150/180/210/220/230TI/250 PS150/ 160 - PA200/ 210 MS300 SUDAMERICA MIDLUM(FAB42B1 / 2- 43C1 / 2- 43T/V) MIDLUM 42B3/4-44TMC.-45D./E. MIDLUM 4x4 47XA/47XC MIDLUM CCF 4X4 (FAB 47XF) MACK MS200/250/300 1990-> MACK CS200/250/300 1990-> MIDLUM(FAB 42US-44US-45US) JE13/ 15 - S170 (FAB-SH) J& S4X4-> 5/ 1991 - S130/150TI/170 (VF6JP) M/S 4X4 & INCENDIE- M210 4X4 MIDLUM(FAB42B1 / 2- 43C1/ 2- 431N) MIDLUM EXPORT (FAB 43E1-43E2)	
52050	---	Stabilizer Bearing Kit	R310 4X2->8/84 - R360 4X2 - JE13/ 15 P/J / P/JN/ P/JP - G260/ 290 - C260/ 290 JP11/ 13 - JK55/ 60/ 65/ 75 JR/ JX19/ 21 - S170 (FAB-SH) GLM/ TLM280 - J & S 4X4 ->5/1991 C210/ CLR220 - G210/ 230 S130/150TI (VF6JN) S130/150TI/170 (VF6JP) R370 JSQ 1984 R370/390/420 ->1989 R310/330/340/365 1984-> S110/130 (VF6JK) - S100 CBH/ CLM280/ 340 G320 - M140/ 160/ 200/ 230 MIDLINER GRANDE-BRETAGNE R 1990->1992 - S140/ 160 C230/ 280/ 300/ 340TI/ CCH300 M/S 4X4 & INCENDIE ME/SE/CE/ 160/180/210 CBH/CLM 320/385 M/S 150/180/210/220/230TI/250 PS150/ 160 - R 1993-> S120/ 135 - G220/270 BOM G200/ 210/ 230TI G MANAGER 4X2 G MANAGER 6X2 & 6X4 G340TI 4X4 - MAXTER 4X2-4X4 MR. C - M210 4X4 - KERAX ==> 1999 PA200/ 210 - MS300 SUDAMERICA MIDLUM(FAB42B1/ 2- 43C1/ 2- 43T/ V) KERAX(FAB33A././S) 2000 ==> MIDLUM 42B3/4-44T/V/C.-45D./E. MIDLUM 4X4 - KERAX (FAB 33AA././SS) MACK MS200/250/300 1990-> MACK CS200/250/300 1990-> MIDLUM(FAB 42US-44US-45US)	
52051	---	Stabilizer Bearing Kit	M/S 150/180/210/220/230TI/250 PS150/ 160 - R 1993-> S120/ 135 - G220/270 BOM G200/ 210/ 230TI G MANAGER 4X2 G MANAGER 6X2 & 6X4 G340TI 4X4 - MAXTER 4X2-4X4 MR. C - M210 4X4 - KERAX ==> 1999 PA200/ 210 - MS300 SUDAMERICA MIDLUM(FAB42B1/ 2- 43C1/ 2- 43T/ V) KERAX(FAB33A././S) 2000 ==> MIDLUM 42B3/4-44T/V/C.-45D./E. MIDLUM 4X4 - KERAX (FAB 33AA././SS) MACK MS200/250/300 1990-> MACK CS200/250/300 1990-> MIDLUM(FAB 42US-44US-45US)	





Auger Nr.	OEM Nr.	Description	Model	Picture
54390	5010 304 948 S	Stabilizer Bearing Kit ø42xø56x25	MAXTER 6X4 8X4 KERAX ==> 1999 KERAX FAB 33A==>S 2000==>2002 KERAX (FAB 33AA.././SS) KERAX (FAB33A.././R) 2003==> KERAX 33G ARMEE BANGLADESH KERAX 33K ARMEE BANGLADESH	 <p>54790 54343</p>
54393	5010 557 129 S 5010 557 130 S 5000 434 716 S	Stabilizer Bearing Kit ø20xø45x66	M140/ 160/ 200/ 230 MIDLINER GRANDE-BRETAGNE ME/ SE/ CE/ 160/ 180/ 210 M/S 150/180/210/220/230TI/250 PS150/ 160 - FA200/ 210 MS300 SUDAMERICA MIDLUM(FAB42B1 /2-43C1 /2-43T/V) MIDLUM 42B3/4-44TMC.-45D./E. MIDLUM 4X4 47XA/47XC MIDLUM GCF 4X4 (FAB 47XF) MACK MS200/250/300 1990-> MACK CS200/250/300 1990-> MIDLUM(FAB 42US-44US-45US) JE13/ 15 - S170 (FAB=SH) J& S4X4-> 5/ 1991 - S130/150TI/170 (VF6JP) M/S 4X4 & INCENDIE - M210 4X4 MIDLUM(FAB42B1 /2-43C1/2-43T/V) MIDLUM EXPORT (FAB 43E1-43E2)	 <p>54798 52009 55284</p>
52052	0000 790 899 S	Stabilizer Bearing Kit ø43xø61x32	TR/GR305 - TR/GR350 H300-CBH/CLM 320/385 GR191/231 - GR/TR280 R 1993-> R310 4X2 ->8/84 G220/270 BOM R360 4X2 G200/210/230TI GLC/GLR190/230 G MANAGER 4X2 G260/290 - C260/290 G MANAGER 6X2 & 6X4 GLM/TLM280 G340TI 4X4 GLR230 4X4 SINPAR MAXTER 4X2-4X4 C210/CLR220 KERAX ==> 1999 G210/230 KERAX FAB 33A==>S R370 JSQ 1984 2000==>2002 R370/390/420 -->1989 KERAX (FAB R310/330/340/365 33AA.././SS) 1984-> KERAX (FAB33A.././R) CBH/CLM280/340 2003==> G320 - R1990->1992 C230/280/300/340TI/CC	 <p>52028 52018 55284</p>
52053	0000 714 088 S	Stabilizer Bearing Kit M20x1.5/101.5	TR/ GR305/ 350 CBH/ CLM280/ 340 GB131/ HR15 AE380/ 385TI/ 420TI/ 500/ 520 GB/ TB191/ 231 - R1990->1992 GC191/ 231- GR191/ 231 C230/ 280/ 300/ 340TI/ GRH235/ HF26 CCH300-MAXTER 6X4 8X4 GR/ TR280 CBH/CLM 320/385 GRH/ TRH305/ 350 R1993->-G230/270 SP TR231D - GF151D G220/270 BOM R310/360 4X2 ->8/84 G200/ 210/ 230TI PJK/ P.JN/ P.JP GMANAGER 4X2 & 6X2 & 6X4 PGC191/ 231 - G340TI 4X4 GLC/ GLR190/ 230 MAXTER 4X2-4X4 R360 6X4 --> 10/1983 AE MANUM390/420TI/ R310 6X4 JSQ 8/1984 430/470/560-KERAX=>1999 GLR230 4X4 SINPAR PG230/ 280 C210/260/290 CLR220 KERAX FAB 33A==>S G170/ 210/ 230/ 260/ 290/ 2000-->2002 320-S130/150TI (VF6JN)-R370 KERAX (FAB 33AA.././SS) JSQ 1984 KERAX (FAB33A.././R) 2003-> R370/390/420 ->1989 KERAX 33G/K ARMEE R310/330/340/365 1984->	 <p>54125 52054 55284</p>
53603	5010 373 300	Stabilizer Mounting ø34xø65x100	M/S 150/180/210/220/230TI/250 S135/150 (MOT 040226) MIDLUM(FAB42B1/2-43C1/2-43T/V) MIDLUM 42B3/4-44T/V/C.-45D./E. MIDLUM(FAB 42US-44US-45US)	
53604	5010 238 596	Stabilizer Mounting ø32xø65x100	M/S 150/180/210/220/230TI/250 S135/150 (MOT 040226) MIDLUM(FAB42B1/2-43C1/2-43T/V)	

Auger Nr.	OEM Nr.	Description	Model	Picture
53665	5000 452 655	Stabilizer Mounting ø35xø68.5x109.5	M140/160/200/230 MIDLINER GRANDE-BRETAGNE M/S 150/180/210/220/230TI/250 PA200/210 MIDLUM(FAB42B1/2-43C1/2-43T/V)	
53668	5430 041 078	Stabilizer Mounting ø41xø68.5x109.5	MIDLINER GRANDE-BRETAGNE M/S 150/180/210/220/230TI/250 MIDLUM(FAB42B1/2-43C1/2-43T/V) MIDLUM EXPORT (FAB 43E1-43E2) MIDLUM 42B3/4-44T/V/C.-45D./E. MIDLUM(FAB 42US-44US-45US)	
52019	5010 130 021	Stabilizer Bearing ø38xø67x60	AE380/385TI/420TI/500/520 R 1993—> G340TI TR 18T MAGNUM PREMIUM	
52020	5010 060 356	Stabilizer Bearing ø52xø90x74	AE380/ 385TI/ 420TI/ 500/ 520 G340TI TR 18T PREMIUM KERAX MAGNUM	
52021	5010 130 022	Stabilizer Bearing ø41xø67x60	AE380/385TI/420TI/500/520 R 1993—> PREMIUM MAGNUM MIDLUM	
52056	5516 031 136	Stabilizer Bearing ø34x59	PJK/PJN/PJP JK55/60/65/75 S110/130 (VF6JK) B90 S100 S140/160 B80/110/120 S120/135	
53602	5516 031 135	Stabilizer Bearing ø40x66	PJK/ PJN/ PJP JN55/ 60/ 85 JP11/ 13 JR/ JX19/ 21 S130/150TI (VF6JN) S110/130 (VF6JK) S100 S140/ 160 M/S 150/180/210/220/230TI/250 PS150/ 160 S120/ 135 S135/150 (MOT 040226)	





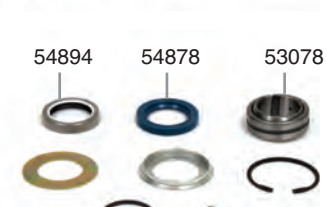

Auger Nr.	OEM Nr.	Description	Model	Picture
53670	5000 391 730	Stabilizer Bearing ø30x65	B70 B90 B80/110/120	
53673	5010 215 010	Stabilizer Bearing ø35.5x66	S140/160 B80/110/120 S120/135 S135/150 (MOT 040226) MASCOTT	
53676	5000 396 856	Stabilizer Bearing ø32xø47.5x80	B70 B90 B80/110/120 MASCOTT	
54007	5010 130 023	Stabilizer Bearing ø33.5xø67x60	C260/290 - C210/CLF220 CBH/CLM280/340 C230/280/300/340TI/CCH300 MAXTER 6X4 8X4 - CBH/CLM 320/385 MAXTER 4X2-4X4 - KERAX => 1999 KERAX FAB 33A=>S - 2000=>2002 MIDLUM 42B3/4-44T/V/C.-45D./E. KERAX (FAB 33AA././SS) KERAX (FAB33A././R) 2003=> MIDLUM(FAB 42US-44US-45US) KERAX 33G ARMEE BANGLADESH KERAX 33K ARMEE BANGLADESH	
52009	5010 557 130 5010 557 129 5000 434 716	Stabilizer Rubber Bushing ø20xø45x66	M140/ 160/ 200/ 230 MIDLINER GRANDE-BRETAGNE ME/SE/CE/ 160/180/210 M/S 150/180/210/220/230TI/250 PS150/ 160 - PA200/ 210 MIDLUM(FAB42B1/ 2- 43C1/ 2- 43T/ V) MIDLUM 42B3/4-44T/V/C.-45D./E. MIDLUM 4X4 47XA/47XC MIDLUM CCF 4X4 (FAB 47XF) MACK MS200/250/300 1990=> MACK CS200/250/300 1990=> MIDLUM(FAB 42US-44US-45US)	
52012	5516 010 769	Stabilizer Rubber Bushing ø18xø34x54	PJK/ PJJ/ PJP S140/ 160 JE13/ 15 - JN55/ 60/ 85 B80/ 110/ 120 JP11/13-JK55/ 60/ 65/ 75 M/S 4X4 & INCENDIE JR/ JX19/ 21 ME/SE/CE/ 160/180/210 S170 (FAB-SH) M/S S130/150TI (VF6JN) 150/180/210/220/230TI/2 S130/150TI/170 (VF6JP) 50 S110/130 (VF6JK) PS150/ 160 - S120/ 135 B90 - S100 S135/150 (MOT 040226) M140/ 160/ 200/ 230 M210 4X4 MIDLINER GRANDE- MIDLUM BRETAGNE MACK - MASCOTT	
52879	5010 383 545	Stabilizer Rubber Bushing ø20xø51.5x41	MAGNUM MIDLUM PREMIUM	

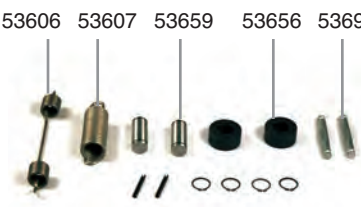

Auger Nr.	O.E.M. Nr.	A	B	C	Type	Repair Kit
54876	5000 787 085	ø43.5	ø55	7.2	1	53717-53719-54662-54663
54877	5010 098 796	ø43	ø57	10.1	1	53718
54878	0024 472 704	ø40.5	ø62	8	1	53718-54665
54893	5000 787 086	ø40.5	ø55	7	1	54664
54894	5010 098 826	ø40.5	ø56	10	1	54665
53078	5010 260 575	ø42	ø62	25	2	53718-54665

Auger Nr.	OEM Nr.	Description	Model	Picture	
54662	5000 785 979 S	Rep. Kit Camshaft ø45xø48x29.5	C210/CLR220 C230/280/300 C340TI/CCH300 C260/290 CBH/CLM 320/385 CBH/CLM280/340 G MANAGER G170 G200/210/230TI G210/230 G220/270 BOM G230/270 SP	G260/290 G320 G340TI 6X6 G340TITR18T KERAX MAGNUM MAXTER MIDLINER PREMIUM R 1990→1992 R 1993→	
54663	5000 785 979 S1	Rep. Kit Camshaft ø45xø48x29.5	AE MAGNUM390/420TI/430/470/560 AE380/385TI/420TI/500/520 MAGNUM E-TECH 400/440/480 PREMIUM 6X2&6X2/4 ==>1999 PREMIUM PR 4X2 ==> 1999 PREMIUM TR 4X2 ==>1999 PREMIUM(FAB22E/H/J/Q/R)2000==> PREMIUM(FAB22EE/HA/HB/JJ/QQ/RR R 1993→		
54664	5000 785 978 S	Rep. Kit Camshaft ø42xø45x30	C230/280/300 C340TI/CCH300 G MANAGER G170 G200/210/230TI G210/230 G220/270 BOM G230/270 SP G260/290 G320 G340TI 6X6	G340TITR18T KERAX M140/160/200/230 M210 4X4 MAGNUM MAXTER PREMIUM R 1990→1992 R 1993→> SISU	
54665	---	Rep. Kit Camshaft ø42xø62x25	KERAX MAGNUM PREMIUM PUNCHER		
52781	5000 816 353	Rep. Kit for Brake Shoe ø31.7x73	G260/290 R370/390/420 →1989 R310/330/340/365 1984→ AE380/385TI/420TI/500/520 R 1990→1992 R 1993→ G MANAGER 6X2 & 6X4 AE MAGNUM390/420TI/430/470/560		

Auger Nr.	OEM Nr.	Description	Model	Picture	
53716	---	Rep. Kit for Brake Shoe ø30	C260/ 290 C210/ CLR220 R370/390/420 ->1989 CBH/ CLM280/ 340 M140/ 160/ 200/ 230 R 1990->1992 CBH/CLM 320/385 R 1993-> G230/270 SP G220/270 BOM G200/ 210/ 230TI	G MANAGER G340TI 6X6 4X4 G340TI TR 18T MAXTER M210 4X4 PG230/ 280 MAGNUM SISU PREMIUM KERAX PUNCHER	
53717	---	Rep. Kit for Brake Shoe ø30	TR/ GR305/ 350 GR191/ 231 GRH235/ HF26 GR/ TR280 GRH/ TRH305 GRH/ TRH350 GBH260/280 6X6 GLC/ GLR190/ 230 C260/ 290 GLM/ TLM280 GLR230 4X4 SINPAR C210/ CLR220 R370 JSQ 1984	R370/390/420>1989 CBH/ CLM280/ 340 CBH/CLM 320/385 R 1993-> G230/270 SP G220/270 BOM G200/ 210/ 230TI G340TI MAXTER MAGNUM PREMIUM KERAX	
53718	---	Rep. Kit for Brake Shoe ø30	PREMIUM MAGNUM KERAX		
53719	---	Rep. Kit for Brake Shoe ø30	GRH235/ HF26 R310 4X2 ->8/84 R360 4X2 GBH/TBH280 1981-> GBH260/280 6X6 GLC/ GLR190/ 230 G260/ 290 C260/ 290 GLM/ TLM280 C210/ CLR220 G170 G210/ 230 R370	CBH/ CLM280/ 340 G320 CBH/CLM 320/385 R 1993-> G230/270 SP G220/270 BOM G200/ 210/ 230TI MANAGER G340TI MAXTER PREMIUM KERAX SISU KERAX	
53720	5000 816 356 S	Rep. Kit for Brake Shoe ø19xø31.7x55.5	G260/290 R370/390/420 ->1989 R310/330/340/365 1984-> AE380/385TI/420TI/500/520 R 1990->1992 R 1993-> G MANAGER 6X2 & 6X4 AE MAGNUM390/420TI/430/470/560		
53721	---	Rep. Kit for Brake Shoe ø19xø31.7x55.5	G260/290 R370/390/420 ->1989 R310/330/340/365 1984-> G320 AE380/385TI/420TI/500/520 R 1990->1992 R 1993-> G MANAGER 6X2 & 6X4 AE MAGNUM390/420TI/430/470/560		







Auger Nr.	OEM Nr.	Description	Model	Picture
53733	---	Rep. Kit for Brake Shoe ø31.7x73	G260/290 R370/390/420 →1989 R310/330/340/365 1984→ R 1990→1992	
53734	---	Rep. Kit for Brake Shoe ø25	G260/ 290/ 320 C260/ 290 C210/ CLR220 G170 G210/ 230 CBH/ CLM280/ 340 M140/ 160/ 200/ 230 R 1990→1992 M/S 4X4 & INCENDIE CBH/CLM 320/385	
53735	---	Rep. Kit for Brake Shoe ø25	G260/290 C260/290 C210/CLR220 G170 G210/230 CBH/CLM280/340 G320 M140/160/200/230 R 1990→1992 CBH/CLM 320/385 R 1993→ G230/270 SP G220/270 BOM	
53736	---	Rep. Kit for Brake Shoe ø25	AE380/ 385TI/ 420TI/ 500/ 520 PREMIUM TR 4X2 ==>1999 PREMIUM 6X2&6X2/4 ==>1999 AE MAGNUM390/420TI/430/470/560 PREMIUM PR 4X2 ==> 1999 MAGNUM E-TECH 400/440/480 PREMIUM TR 4X2 2000 ==> PREMIUM(FAB22E/ H/ J/ Q/ R) 2000==> KERAX FAB 33A==>S 2000==>2002 PREMIUM(FAB22EE/ HA/ HB/ JJ/ QQ/ RR KERAX (FAB 33AA/././SS) KERAX (FAB33A/././R) 2003==>	
53737	5000 716 008	Rep. Kit for Brake Shoe ø25	TR/GR305 TR/GR350 GR191/231 GRH235/HF26 GR/TR280 GRH/TRH305 GRH/TRH350 TF231D R310 4X2 ->8/84 R360 4X2 GBH/TBH280 1981-> GBH260/280 6X6 GBH260/280 6X4 ->1980 GLC/GLR190/230	
53738	---	Rep. Kit for Brake Shoe	TR/ GR305 TR/ GR350 GR191/ 231 GRH235/ HF26 GR/ TR280 GRH/ TRH305 GRH/ TRH350 TF231D R310 4X2 ->8/84 R360 4X2 GBH/TBH280 1981-> GBH260/280 6X6 GBH260/280 6X4->1980 GLC/ GLR190/ 230	

Auger Nr.	OEM Nr.	Description	Model	Picture	
53743	---	Rep. Kit for Brake Shoe ø30	G260/290 C260/290 C210/CLR220 G170 G210/230 R370/390/420 →1989 R310/330/340/365 1984→ G230/270 SP		
53744	---	Rep. Kit for Brake Shoe	G260/290 C260/290 C210/CLR220 G170 G210/230 R370/390/420 →1989 R310/330/340/365 1984→ G230/270 SP		
52779	5000 816 359	Brake Shoe Spring ø25x227	G260/290 R370/390/420 →1989 R310/330/340/365 1984→ G320 AE380/385TI/420TI/500/520 "R" 1990→1992" "R" 1993→" "G" MANAGER 6X2 & 6X4" AE MAGNUM390/420TI/430/470/560		
53605	5010 098 945	Brake Shoe Spring ø35x240	MAGNUM KERAX PREMIUM PUNCHER		
53606	5010 097 089	Brake Shoe Spring ø30x233	G260/290 C260/290 C210/CLR220 G170 G210/230 CBH/CLM280/340 G320 M140/160/200/230 MAXTER R 1993→ G230/270 SP G220/270 BOM	G200/210/230TI G MANAGER G340TI 6X6 G340TI 4X4 G340TI TR 18T M210 4X4 PG230/280 MAGNUM SISU PREMIUM KERAX	
53607	5010 097 340	Brake Shoe Spring ø38x145	G260/290 C260/290 C210/CLR220 G170 G210/230 CBH/CLM280/340 G320 M140/160/200/230 MAXTER R 1993→ G230/270 SP G220/270 BOM	G200/210/230TI G MANAGER G340TI 6X6 G340TI 4X4 G340TI TR 18T M210 4X4 PG230/280 MAGNUM SISU PREMIUM KERAX	

Auger Nr.	OEM Nr.	Description	Model	Picture	
53654	0023 532 373	Brake Shoe Spring ø32x167	TR/GR305 - TR/GR350 GB131/HR15 GB/TB191/231 GC191/231 - GR191/231 GRH235/HF26 GR/TR280-GRH/TRH305 GRH/TRH350 TF231D - GF151D R310 4X2 ->8/84 R360 4X2 GBH/TBH280 1981-> PJK/PJN/PJP PGC191/231 GBH260/280 6X6	GBH260/280 6X4->1980 GLC/GLR190/230 JE13/15 - G260/290 C260/290 R360 6X4 -> 10/1983 R310 6X4 JSQ 8/1984 S170 (FAB-SH) GLM/TLM280 C210/CLR220 - G170 G210/230 R370 JSQ 1984 CBH/CLM280/340 ME/SE/CE/ 160/180/210 G230/270 SP	
53691	5005 016 005	Brake Shoe Spring ø38x156	TR/ GR305 TR/ GR350 GR191/ 231 GRH235/ HF26 GR/ TR280 GRH/ TRH305 GRH/ TRH350 TF231D R310 4X2 ->8/84 R360 4X2 GBH/TBH280 1981-> GBH260/280 6X6	GLC/ GLR190/ 230 G260/ 290 C260/ 290 R360 6X4 -> 10/1983 R310 6X4 JSQ 8/1984 GLM/ TLM280 C210/ CLR220 G170/210/ 230 R370 JSQ 1984 CBH/ CLM280/ 340 G230/270 SP	
53699	0000 174 268	Return Spring ø32x200	GRH235/ HF26 - GR/TR280 R310 4X2 ->8/84 - R360 4X2 GBH/TBH280 1981-> GBH260/280 6X6 GBH260/280 6X4->1980 GLC/ GLR190/ 230 G260/ 290 - C260/ 290 R360 6X4 -> 10/1983 R310 6X4 JSQ 8/1984 GLM/ TLM280 C210/ CLR220 - G170 G210/ 230-R370 JSQ 1984 R370/390/420 ->1989	R310/330/340/365 1984-> CBH/ CLM280/ 340 R 1990->1992 C230/ 280/ 300/ 340TI/ CCH300 - CBH/CLM 320/385 R 1993-> - G230/270 SP G220/270 BOM G200/ 210/ 230TI G MANAGER 4X2 G MANAGER 6X2 & 6X4 - G340TI 4X4 - G340TI TR 18T MAGNUM PREMIUM	
54357	0000 241 884	Return Spring ø24x172	GLM/TLM280 GLR230 4X4 SINPAR C210/CLR220 R370 JSQ 1984 CBH/CLM 320/385 TR/GR350		
54359	0000 492 878	Return Spring ø23x208	GRH235/HF26 GRH/TRH305 GRH/TRH350 GBH/TBH280 1981-> G260/290 C260/290 R360 6X4->10/1983 R310 6X4 JSQ 8/1984 R370 JSQ 1984 R370/390/420->1989	CBH/CLM280/340 R 1990->1992 MAXTER CBH/CLM 320/385 R 1993-> G MANAGER G340TI 6X6 MAGNUM 2000=>2002 KERAX	
53656	5000 716 656	Brake Shoe Roller ø25xø50x24.5	G260/ 290/ 320 C210/ CLR220 G170 G210/ 230 CBH/ CLM280/ 340 G230/270 SP G220/270 BOM G200/ 210/ 230TI	G MANAGER G340TI 6X6 4X4 G340TI TR 18T MAXTER PG230/ 280 MAGNUM SISU PREMIUM KERAX	
53657	0000 189 976	Brake Shoe Roller ø25xø60x20	TR/GR305 TR/GR350 GR191/231 GRH235/HF26 GR/TR280 GRH/TRH305 GRH/TRH350 TF231D R310 4X2 ->8/84 R360 4X2	GBH260/280 6X6 GLC/GLR190/230 G260/290 C260/290 GLM/TLM280 C210/CLR220 G170 G210/230 R370 JSQ 1984 G230/270 SP	

Auger Nr.	OEM Nr.	Description	Model	Picture	
52373	5000 816 353 S	Brake Shoe Pin ø31.7x73	G260/290 R370/390/420 →1989 R310/330/340/365 1984→ AE380/385TI/420TI/500/520 R 1990→1992 R 1993→ G MANAGER 6X2 & 6X4 AE MAGNUM390/420TI/430/470/560		
53659	5000 716 600	Brake Shoe Pin ø25x63	G260/ 290/ 320 C260/ 290 C210/ CLR220 G170 G210/ 230 CBH/ CLM280/ 340 G230/270 SP G220/270 BOM G200/ 210/ 230TI	G MANAGER G340TI 6X6 4X4 G340TI TR 18T MAXTER PG230/ 280 MAGNUM SISU PREMIUM KERAX	
53660	5000 737 308	Brake Shoe Pin ø30x110.5	G260/290 C260/290 C210/CLR220 G170 G210/230 R370/390/420 →1989 R310/330/340/365 1984→ G230/270 SP		
53661	5000 737 307	Brake Shoe Pin ø30x93	R/ GR305 TR/ GR350 GR191/ 231 GRH235/ HF26 GR/ TR280 GRH/ TRH305 GRH/ TRH350 TF231D R310 4X2 →8/84 R360 4X2 GBH/TBH280 1981→ GBH260/280 6X6 GBH260/280 6X4 →1980 GLC/ GLR190/ 230 G260/ 290 C260/ 290	R360 6X4 → 10/1983 R310 6X4 JSQ 8/1984 GLM/ TLM280 GLR230 4X4 SINPAR C210/ CLR220 G170 - G210/ 230 R370 JSQ 1984 R370/390/420 →1989 R310/330/340/365 1984→ CBH/ CLM280/ 340 G230/270 SP	
53662	0000 192 399	Brake Shoe Pin ø25x75	TR/ GR305 TR/ GR350 GR191/ 231 GRH235/ HF26 GR/ TR280 GRH/ TRH305 GRH/ TRH350 TF231D R310 4X2 →8/84 R360 4X2 GBH260/280 6X6	GLC/ GLR190/ 230 G260/ 290 C260/ 290 GLM/ TLM280 GLR230 4X4 SINPAR C210/ CLR220 G170 G210/ 230 R370 JSQ 1984 CBH/ CLM280/ 340 G230/270 SP	
53681	5010 067 400	Brake Shoe Pin ø19.5xø30x104	C260/ 290 C210/ CLR220 CBH/ CLM280/ 340 M140/ 160/ M 200/ 230 G230/270 SP G220/270 BOM G200/ 210/ 230TI G MANAGER G340TI 6X6 4X4	G340TI TR 18T MAXTER M210 4X4 PG230/ 280 MAGNUM SISU PREMIUM KERAX PUNCHER	
52368	5000 816 356	Cam Roller ø19xø31.7x55.5	G260/290 R370/390/420 →1989 R310/330/340/365 1984→ AE380/385TI/420TI/500/520 R 1990→1992 R 1993→ G MANAGER 6X2 & 6X4 AE MAGNUM390/420TI/430/470/560		

Auger Nr.	OEM Nr.	Description	Model	Picture	
53658	5010 098 946	Brake Shoe Spring Pin ø15x76	MAGNUM KERAX PREMIUM PUNCHER		
53685	5000 816 358	Brake Shoe Spring Pin ø12x64	G260/290 R370/390/420 →>1989 R310/330/340/365 1984→> G320 AE380/385TI/420TI/500/520 R 1990→>1992 R 1993→> G MANAGER 6X2 & 6X4 AE MAGNUM390/420TI/430/470/560		
53690	5010 097 262	Brake Shoe Spring Pin ø12x96	G260/290 C260/290 C210/CLR220 G170 G210/230 CBH/CLM280/340 G320 M140/160/200/230 MAXTER R 1993→> G230/270 SP G220/270 BOM	G200/210/230TI G MANAGER G340TI 6X6 G340TI 4X4 G340TI TR 18T M210 4X4 PG230/280 MAGNUM SISU PREMIUM KERAX	
52246	5000 816 369	Dust Cover Set Phosphated & Painted ø230xø467x65	G260/ 290 R370/390/420 →>1989 R310/330/340/365 1984→> AE380/ 385TI/ 420TI/ 500/ 520 R 1990→>1992 R 1993→> G MANAGER 6X2 & 6X4 AE MAGNUM390/420TI/430/470/560		
53062	5000 816 935	Dust Cover Set Phosphated & Painted ø230xø465x54	G260/290 R370/390/420 →>1989 R310/330/340/365 1984→> R 1990→>1992		
53121	7420 367 343	Dust Cover Phosphated & Painted ø234xø446x54	KERAX DXI		
53644	5010 098 794 5010 098 795	Dust Cover Phosphated & Painted ø245xø466x46	MAGNUM KERAX PREMIUM PUNCHER		

Auger Nr.	OEM Nr.	Description	Model	Picture	
52206	5000 816 349	Brake Camshaft Bushing ø38.2xø42x44.8	G260/290 R370/390/420 →1989 R310/330/340/365 1984→ AE380/385TI/420TI/500/520 R 1990→1992 R 1993→ G MANAGER 6X2 & 6X4 AE MAGNUM390/420TI/430/470/560		
53683	5000 785 979	Brake Camshaft Bushing ø45xø48x29.5	C260/ 290 C210/ CLR220 CBH/ CLM280/ 340 M140/ 160/ M 200/ 230 G230/270 SP G220/270 BOM G200/ 210/ 230TI G MANAGER G340TI 6X6 4X4	G340TI TR 18T MAXTER M210 4X4 PG230/ 280 MAGNUM SISU PREMIUM KERAX PUNCHER	
53684	5005 010 008	Brake Camshaft Bushing ø45xø48x53	R310 4X2 →8/84 R360 4X2 GBH260/280 6X6 GLC/ GLR190/ 230 G260/ 290 C260/ 290 GLM/ TLM280 C210/ CLR220 G170 G210/ 230 R370 JSQ 1984 CBH/ CLM280/ 340 G320 R 1990→1992	MAXTER 6X4 8X4 CBH/CLM 320/385 G230/270 SP G220/270 BOM G200/ 210/ 230TI G MANAGER G340TI 6X6 G340TI 4X4 G340TI TR 18T MAXTER PREMIUM KERAX SISU KERAX	
54647	5000 785 978	Brake Camshaft Bushing ø42xø45x30	GB131/HR15 GB/TB191/231 GC191/231 GRH235/HF26 GRH/TRH305 GRH/TRH350 GF151D PGC191/231 G260/290 C260/290 G170 G210/230 R370 JSQ 1984	R 1990→1992 G230/270 SP G200/210/230TI G MANAGER G340TI 6X6 G340TI TR 18T MAXTER M210 4X4 MAGNUM KERAX PREMIUM SISU KERAX	
53682	5010 216 613	Brake Shoe Bushing ø30xø33x45	C260/ 290 C210/ CLR220 M140/ 160/ M 200/ 230 G230/270 SP G220/270 BOM G200/ 210/ 230TI G MANAGER G340TI 6X6 4X4	G340TI TR 18T MAXTER M210 4X4 PG230/ 280 MAGNUM SISU PREMIUM KERAX PUNCHER	
53692	5000 786 674	Brake Shoe Bushing ø30xø33x20	TR/GR305 TR/GR350 GR191/231 GRH235/HF26 GR/TR280 GRH/TRH305 GRH/TRH350 TF231D R310 4X2 →8/84 R360 4X2 GBH/TBH280 1981→ GBH260/280 6X6 GBH260/280 6X4 → >1980 GLC/GLR190/230	G260/290 C260/290 R360 6X4 →10/1983 R310 6X4 JSQ 8/1984 GLM/TLM280 GLR230 4X4 SINPAR C210/CLR220 G170 G210/230 R370 JSQ 1984 R370/390/420 →1989 R310/330/340/365 1984→ CBH/CLM280/340 G230/270 SP	
52207	5000 816 347	Spherical Bearing ø38xø60x55	G260/ 290 R370/390/420 →1989 R310/330/340/365 1984→ AE380/ 385TI/ 420TI/ 500/ 520 R 1990→1992 R 1993→ G MANAGER 6X2 & 6X4 AE MAGNUM390/420TI/430/470/560		

Diaphragms - Normal Stroke







Auger Nr.: 52576	
O.E.M. Nr. —	
Type	9"
Auger Nr.: 52578	
O.E.M. Nr. —	
Type	12"
Auger Nr.: 52580	
O.E.M. Nr. —	
Type	16"
Auger Nr.: 52581	
O.E.M. Nr. —	
Type	20"
Auger Nr.: 52582	
O.E.M. Nr. —	
Type	24"
Auger Nr.: 52583	
O.E.M. Nr. —	
Type	30"
Auger Nr.: 52584	
O.E.M. Nr. —	
Type	36"









Diaphragms - Long Stroke







Auger Nr.: 52585	
O.E.M. Nr. —	
Type	16"
Auger Nr.: 52586	
O.E.M. Nr. —	
Type	20"
Auger Nr.: 52587	
O.E.M. Nr. —	
Type	24"
Auger Nr.: 52588	
O.E.M. Nr. —	
Type	30"

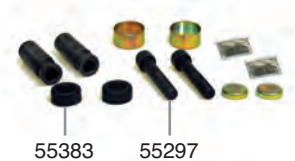

Auger Nr.	OEM Nr.	Description	Model	Picture
21010	---	Service Brake Chamber (For Drum Brake) 112.5/126xM16x1.5 T16 STR 75	---	
21011	5021 170 047	Service Brake Chamber (For Drum Brake) (with repair kit) 112.5/126xM16x1.5 T16 STR 75	---	
21012	---	Service Brake Chamber (For Drum Brake) 113/126xM16x1.5 T20 STR 75	---	
21013	5021 170 049	Service Brake Chamber (For Drum Brake) (with repair kit) 113/126xM16x1.5 T20 STR 75	---	
21014	---	Service Brake Chamber (For Drum Brake) 112,5/126xM16x1.5 T24 STR 75	---	
21015	0038 855 200 4231 069 000 5000 809 565 5021 170 051	Service Brake Chamber (For Drum Brake) (with repair kit) 112,5/126xM16x1.5 T24 STR 75	---	

Auger Nr.	OEM Nr.	Description	Model	Picture
21016	---	Service Brake Chamber (For Drum Brake) 117,5/131xM16x1.5 T30 STR 75	---	
21017	5000 815 361 5021 170 052	Service Brake Chamber (For Drum Brake) (with repair kit) 117,5/131xM16x1.5 T30 STR 75	G 260/290	
21018	---	Double Diaphragm Brake Chamber (For Drum Brake) 274,5/375.5xM16x1.5 T24-30 STR 75/75	---	
21019	5021 170 326	Double Diaphragm Brake Chamber (For Drum Brake) (with repair kit) 274,5/375.5xM16x1.5 T24-30 STR 75/75	---	
21020	---	Double Diaphragm Brake Chamber (For Drum Brake) 271,5/372.5xM16x1.5 T30-30 STR 75/75	---	
21021	5021 170 327	Double Diaphragm Brake Chamber (For Drum Brake) (with repair kit) 271,5/372.5xM16x1.5 T30-30 STR 75/75	---	
31028	5010 216 437	Brake Disc ø131xø438	MAGNUM	

Auger Nr.	OEM Nr.	Description	Model	Picture
53874	5001 837 006	Rep. Kit for Brake Caliper Ror Type	AE380/385TI/420TI/500/520 PREMIUM TR 4X2 ==>1999 PREMIUM 6X2&6X2/4 ==>1999 AE MAGNUM390/420TI/430/470/560 PREMIUM PR 4X2 ==> 1999 PREMIUM 260 SP MAGNUM E-TECH 400/440/480 PREMIUM TR 4X2 2000 ==> PREMIUM(FAB22E/H/J/Q/R)2000==> PREMIUM PR 4X2 (FAB22A)2000==> PREMIUM PR 4X2 (FAB 22AA/AB) PREMIUM 22C 071 ==> 1999	 <p>55305 55301 55365</p>
54169	5001 866 989	Rep. Kit for Brake Caliper Ror Type	MAGNUM DXI12 FAB17JD/RD/SD/TD PREMIUM -TR--FAB-27JC/TC PREMIUM -PR--FAB-27RC/SC MIDLUM DXI5/7-FAB-44.A/B/E/UM PREMIUM DXI 7 -FAB-29.By29.G MAGNUM DXI13 FAB17JE/RE/SE/TE PREMIUM -TR--FAB-24.F/25.C PREMIUM -PR--FAB-24.F/25.C MAGNUM DXI13 FAB17JF/RF/SF/TF	 <p>55304 55303 55369 55294 55302</p>
54170	5001 858 717	Rep. Kit for Brake Caliper Ror Type	MAGNUM E-TECH 400/440/480 PREMIUM(FAB22E/ H/ J/ Q/ R) 2000==> PREMIUM PR 4X2 (FAB22A)2000==> PREMIUM TRACTEUR 4X2(FAB 22CC) PREMIUM(FAB22EE/ HA/ HB/ JJ/ QQ/ RR PREMIUM PR 4X2 (FAB 22AA/AB)	 <p>55301 55300 55384 55369</p>
54171	5001 860 791	Rep. Kit for Brake Caliper Ror Type	MAGNUM E-TECH 400/440/480 MIDLUM 42B3/4-44TMC.-45D./E. PREMIUM TRACTEUR 4X2(FAB 22CC) PREMIUM(FAB22EE/ HA/ HB/ JJ/ QQ/ RR PREMIUM PR 4X2 (FAB 22AA/AB) SISU	 <p>55296 55295 55384 55369</p>
54172	5001 866 400	Rep. Kit for Brake Caliper Ror Type	MAGNUM DXI 12-VAR-120AV PREMIUM DXI 11-FAB-27JC/TC PREMIUM DXI 11-FAB-27RC/SC	 <p>55302 55369 55294 55304</p>
54173	5001 858 718 5001 860 792	Rep. Kit for Brake Caliper Ror Type	MAGNUM E-TECH 400/440/480 PREMIUM(FAB22E/ H/ J/ Q/ R) 2000==> PREMIUM PR 4X2 (FAB22A)2000==> PREMIUM TRACTEUR 4X2(FAB 22CC) PREMIUM(FAB22EE/ HA/ HB/ JJ/ QQ/ RR PREMIUM PR 4X2 (FAB 22AA/AB) MIDLUM 42B3/4-44TMC.-45D./E. SISU	 <p>55369 55384 55351</p>

Auger Nr.	OEM Nr.	Description	Model	Picture
54174	5001 866 398	Rep. Kit for Brake Caliper Ror Type	MAGNUM DXI 12-VAR-120AV PREMIUM DXI 11-FAB-27JC/TC PREMIUM DXI 11-FAB-27RC/SC	 <p>55351</p>
54175	5001 822 994	Rep. Kit for Brake Caliper Ror Type	AE380/385TI/420TI/500/520 PREMIUM TR 4X2 ==>1999 PREMIUM 6X2&6X2/4 ==>1999 AE MAGNUM390/420TI/430/470/560 PREMIUM PR 4X2 ==> 1999	 <p>55297 55298 55368</p>
54557	5000 821 966	Rep. Kit for Brake Caliper Ror Type	R370/390/420 --->1989 AE380/385TI/420TI/500/520 R 1990--->1992 R 1993--->	 <p>55383 55297</p>
55176	5001 831 176	Rep. Kit for Brake Caliper Ror Type	AE380/385TI/420TI/500/520 PREMIUM TR 4X2 ==>1999 PREMIUM 6X2&6X2/4 ==>1999 AE MAGNUM390/420TI/430/470/560 PREMIUM PR 4X2 ==> 1999	 <p>55346 55329 55330</p>
54558	5021 170 487	Rep. Kit for Brake Caliper --- Wabco Type		 <p>55350 55334 55379 55299 55322</p>
54561	5001 852 880	Rep. Kit for Brake Caliper --- Wabco Type		 <p>55326 55335 55354 55325</p>

Auger Nr.	OEM Nr.	Description	Model	Picture
54562	5001 858 722	Rep. Kit for Brake Caliper Wabco Type	---	 <p>55350 55323 55334 55299</p>
54569	5021 170 488	Rep. Kit for Brake Caliper Wabco Type	---	 <p>55334 55299 55379 55322</p>
21948	7420 904 408	Air Tank ø276/30 L	MAGNUM DXI13 FAB17JE/RE/SE/TE PREMIUM -TR--FAB-24.F/25.C PREMIUM -PR--FAB-24.F/25.C KERAX DXI 13 -FAB-36.D/36.E MAGNUM DXI13 FAB17JF/RF/SF/TF	
21949	7420 904 411	Air Tank ø276/40 L	MAGNUM DXI12 FAB17JD/RD/SD/TD PREMIUM -TR--FAB-27JC/TC PREMIUM -PR--FAB-27RC/SC KERAX DXI 11 -FAB-34.C/34.F PREMIUM DXI 7 -FAB-29.B/29.G MAGNUM DXI13 FAB17JE/RE/SE/TE PREMIUM -TR--FAB-24.F/25.C PREMIUM -PR--FAB-24.F/25.C KERAX DXI 13 -FAB-36.D/36.E MAGNUM DXI13 FAB17JF/RF/SF/TF	
21903	7700 053 246	Air Tank ø246/20 L	---	
21904	5021 170 368	Air Tank ø246/30 L	---	

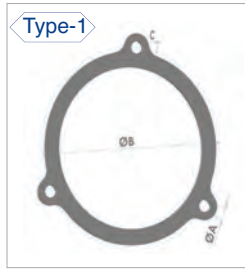



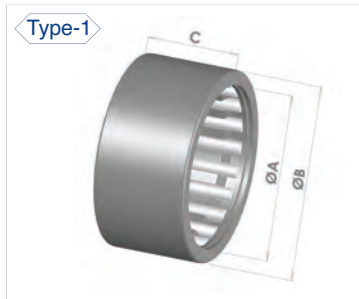



Auger Nr.	O.E.M. Nr.	A	B	C	Type	Repair Kit
54346	5010 368 902	ø9	ø150	1.5	1	-
54843	5010 439 197	ø46	ø54.5	4	2	52607
54844	5010 439 196	ø39.5	ø47	4	2	52619
54845	5010 439 192	ø34	ø42	4	3	52620
54857	5010 439 191	ø27.5	ø35	4	3	52621-53710-53711
54858	5010 439 193	ø29.5	ø37	4	3	52573
54879	5010 439 195 5000 788 257	ø49	ø58	4	3	53708-53709
54863	5516 015 830	ø30.5	ø55	15	4	53710-52573-52621-53711
54864	5516 015 736	ø35.5	ø61	14.5	4	52620
54887	7401 078 240	ø48	ø73	11.5	5	54672
54888	7403 173 774	ø50	ø72	8.5	5	54672



Auger Nr.	O.E.M. Nr.	A	B	C	Type	Repair Kit
54480	5010 439 415	ø50	ø58	25	1	53708-53709
54498	-	ø30.416	ø55.562	15.875	2	53707
54585	5010 056 928	ø46.1	ø78	22	2	52607
54586	5010 056 925	ø40	ø72.6	19	2	52575-52619
54594	5010 358 235	ø49	ø80	22	2	53708-53709
54595	0023 364 036	ø35.179	ø59.4	15.875	2	53731-53732
54812	5003 090 091	ø46	ø83	24	2	52572-54385
54813	5000 542 810	ø35.5	ø53	15	2	52620
54815	5000 542 808 5000 542 809	ø30.4	ø48.1	15	2	52573-52621 53710-53711
54828	7403 173 772	ø40	ø90	39	3	54672



Auger Nr.	O.E.M. Nr.	A	B	C	Type	Repair Kit
54604	5000 737 796	ø46	ø54	69	1	52607
54605	5010 056 582	ø40	ø47	57	1	52619
54606	5000 444 291	ø35	ø42	42	1	52620
54609	0000 189 901	ø40	ø44	60	1	52575
54610	5000 446 522	ø28	ø35	29.5	1	52621
54611	5000 446 523	ø28	ø35	34	1	52621
54616	-	ø30	ø34	50	1	53707
54617	5000 389 326	ø27.5	ø35	33	1	53710-53711
54618	0000 190196	ø35	ø39	60	1	53731-53732
54619	5000 389 327	ø28	ø35	33	1	53710-53711
54898	5005 010 016	ø47	ø51	71	1	52572-54385
54899	5000 444 290	ø35	ø42	37.5	1	52620
54903	5000 351 633	ø30	ø37	34.5	1	52573
54904	5000 351 634	ø30	ø37	39	1	52573
54908	5000 792 140	ø50	ø58	50	1	53708-53709
54914	5001 852 792	ø70	ø75	60	1	54671
54644	5001 821 839	ø60	ø65	70	2	54670
54788	7403 173 775	ø60	ø65	50.5	3	54672

Auger Nr.	OEM Nr.	Description	Model	Picture
52572	5000 794 320	King Pin Set, Single ø46x280	GR191/231 GRH235/HF26 GRH/TRH305 GRH/TRH350 R310 4X2 ->8/84 R360 4X2 GBH/TBH280 1981-> GBH260/280 6X4 ->1980 GLC/GLR190/230 G260/290 C260/290	 <p>54898 54812</p>
54385	5000 794 320 S	King Pin Set ø46x280	R360 6X4 -> 10/1983 R310 6X4 JSQ 8/1984 GLM/TLM280 C210/CLR220 G210/230 R370 JSQ 1984 R370/390/420 ->1989 R310/330/340/365 1984-> CBH/CLM280/340	 <p>54898 54812</p>
52573	5000 336 306	King Pin Set ø30x167	JN55/60/85 S130/150TI (VF6JN) S100 MIDLINER GRANDE-BRETAGNE S140/160 M/S 150/180/210/220/230TI/250 PS150/160 S120/135 S135/150 (MOT 040226)	 <p>54858 54903 54904 54863 54815</p>
52575	5000 784 185 5000 794 319	King Pin Set ø40x236	GC191/231 TF231D GF151D PGC191/231 GLC/GLR190/230 G260/290 G170 G210/230 G230/270 SP	 <p>54586 54609</p>
52607	5000 793 849	King Pin Set ø46x280	GR191/ 231 GRH235/ HF26 GRH/ TRH305 GRH/ TRH350 R310 4X2 ->8/84 R360 4X2 GBH/TBH280 1981-> GBH260/280 6X4 -> >1980 GLC/ GLR190/ 230 G260/ 290 C260/ 290 R360 6X4 -> 10/1983 R310 6X4 JSQ 8/1984 GLM/ TLM280 C210/ CLR220	 <p>G210/ 230 R370 JSQ 1984 R370/390/420 ->1989 R310/330/340/365 1984-> CBH/ CLM280/ 340 G320 R 1990->1992 C230/ 280/ 300/ 340TI/ CCH300 CBH/CLM 320/385 R 1993-> G220/270 BOM G200/ 210/ 230TI G MANAGER 4X2 G MANAGER 6X2 & 6X4</p> <p>54604 54585 54843</p>
52619	5000 793 828	King Pin Set ø40x241	GC191/231 GLC/GLR190/230 G260/290 G170 G210/230 G320 M140/160/200/230 MIDLINER GRANDE-BRE- TAGNE C230/280/300/340 TI/CCH300	 <p>M/S 150/180/210/220/2 30TI/250 G230/270 SP G220/270 BOM G200/210/230TI G MANAGER 4X2 G MANAGER 6X2 & 6X4 G340TI TR 18T PG230/280</p> <p>54605 54844 54586</p>

Auger Nr.	OEM Nr.	Description	Model	Picture
52620	5000 336 305	King Pin Set ø35x178.5	JE13/15 JP11/13 JR/JX19/21 S170 (FAB=SH) S130/150TI/170 (VF6JP) M/S 4X4 & INCENDIE ME/SE/CE/ 160/180/210 PS150/160 MACK MS200/250/300 1990—> MACK CS200/250/300 1990—>	 <p>54606 54899 54845 54813 54864</p>
52621	5000 793 641	King Pin Set ø28x153.5	JK55/60/65/75 S110/130 (VF6JK) S100 MIDLINER GRANDE-BRETAGNE S140/160 M/S 150/180/210/220/230TI/250 S120/135 S135/150 (MOT 040226)	 <p>54610 54611 54863 54815 54857</p>
53707	0000 323 906	King Pin Set ø30x213	---	 <p>54616 54498</p>
53708	5010 216 742 S	King Pin Set ø50x236	AE420TI AE520 PREMIUM TR 4x2 2000 —>	 <p>54480 54594 54908 54879</p>
53709	5010 056 002 S	King Pin Set ø50x225	G260/290 R370/390/420 —> 1989 AE380/385TI/420TI/500/520 BUS TRACER PR112/118 PREMIUM (6x2) (6x2/4) —> 1989 PREMIUM (FAB 22E/H/J/Q/R) 2000 —> MAXTER (4x2) (4X4) (6x4) (8x4) KERAX	 <p>54480 54594 54908 54879</p>
53710	5001 836 749	King Pin Set ø27.5/ø28x153	B70 B90 B80/110/120	 <p>54863 54815 54619 54617 54857</p>

Auger Nr.	OEM Nr.	Description	Model	Picture
53711	5000 793 360	King Pin Set ø27.5/ø28x153	B70 J35/48/55/60	 <p>54863 54815 54619 54617 54857</p>
53731	5000 793 139	King Pin Set ø35x224	GB131/HR15 GB/TB191/231 G260/290 G170	 <p>54595 54618</p>
53732	0000 323 944	King Pin Set ø35x242	GB131/HR15 GB/TB191/231	 <p>54595 54618</p>
54670	5001 821 848 S	King Pin Set ø58/ø60x297	AE380/385TI/420TI/500/520 R 1993---> G MANAGER 4X2 AE MAGNUM390/420TI/430/470/560	 <p>54644</p>
54671	5001 852 793 S	King Pin Set ø70x295	PREMIUM 6X2&6X2/4 ==>1999 AE MAGNUM390/420TI/430/470/560 MAGNUM E-TECH 400/440/480 PREMIUM(FAB22E/H/J/Q/R)2000==> PREMIUM(FAB22EE/HA/HB/JJ/QQ/RR	 <p>54914</p>
54672	7420 590 486 S	King Pin Set ø40/ø60x226	MAGNUM DXI12 FAB17JD/RD/SD/TD PREMIUM -TR--FAB-27JC/TC PREMIUM -PR--FAB-27RC/SC KERAX DXI 11 -FAB-34.C/34.F PREMIUM DXI 7 -FAB-29.B/29.G MAGNUM DXI13 FAB17JE/RE/SE/TE PREMIUM -TR--FAB-24.F/25.C PREMIUM -PR--FAB-24.F/25.C KERAX DXI 13 -FAB-36.D/36.E MAGNUM DXI13 FAB17JF/RF/SF/TF	 <p>54828 54788 54888 54887</p>

Auger Nr.	OEM Nr.	Description	Model	Picture
53615	5010 571 187	Hub Cap ø124x52	PREMIUM TR 4X2 ==>1999 AE MAGNUM390/420TI/430/470/560 MAGNUM E-TECH 400/440/480 PREMIUM TR 4X2 2000 ==> PREMIUM(FAB22E/H/J/Q/R)2000==> PREMIUM PR 4X2 (FAB22A)2000==> KERAX FAB 33A==>S 2000==>2002 MIDLUM 42B3/4-44TA//C.-45D./E. PREMIUM TRACTEUR 4X2(FAB 22CC) PREMIUM(FAB22EE/HA/HB/JJ/QQ/RR PREMIUM PR 4X2 (FAB 22AA/AB) KERAX (FAB 33AA/././SS) KERAX (FAB33A/././R) 2003==> SISU	
54345	5010 368 906	Hub Cap ø8.5/136.5x108x47.5	PREMIUM TR 4X2 ==>1999 PREMIUM 6X2&6X2/4 ==>1999 PREMIUM PR 4X2 ==> 1999 MAGNUM E-TECH 400/440/480 PREMIUM(FAB22E/ H/ J/ Q/ R) 2000==> PREMIUM(FAB22EE/ HA/ HB/ JJ/ QQ/ RR	
54347	7403 988 672	Hub Cap M128x2/50xSW115	MAGNUM DXI 12-VAR-120AV PREMIUM DXI 11-FAB-27JC/TC PREMIUM DXI 11-FAB-27RC/SC	
54348	7420 547 252	Hub Cap M112x2/50xSW115	MAGNUM DXI 12-VAR-120AV PREMIUM DXI 11-FAB-27JC/TC PREMIUM DXI 11-FAB-27RC/SC	
54219	7420 399 428	Cap for Steering Knuckle M93x3/ø106x31	MAGNUM DXI 12 -VAR-120AV PREMIUM DXI 11 -FAB-27JC/TC PREMIUM DXI 11 -FAB-27RC/SC	
54648	7401 078 564	Cap for Steering Knuckle ø86x20	MAGNUM DXI12 FAB17JD/RD/SD/TD PREMIUM -TR--FAB-27JC/TC PREMIUM -PR--FAB-27RC/SC KERAX DXI 11 -FAB-34.C/34.F PREMIUM DXI 7 -FAB-29.B/29.G MAGNUM DXI13 FAB17JE/RE/SE/TE PREMIUM -TR--FAB-24.F/25.C PREMIUM -PR--FAB-24.F/25.C KERAX DXI 13 -FAB-36.D/36.E MAGNUM DXI13 FAB17JF/RF/SF/TF	
54344	5001 852 775	Silent Block ø20xø63x72.5	PREMIUM 6X2&6X2/4 ==>1999 AE MAGNUM390/420TI/430/470/560 MAGNUM E-TECH 400/440/480 PREMIUM(FAB22E/ H/ J/ Q/ R) 2000==> PREMIUM(FAB22EE/ HA/ HB/ JJ/ QQ/ RR	

Auger Nr.	OEM Nr.	Description	Model	Picture	
54004	5000 815 713	Axle Nut M56x2xSW85	MAGNUM MAJOR G MANAGER		
54349	5000 682 800	Thrust Washer ø95xø120x24	C260/ 290 R360 6X4 R310 6X4 JSQ 8/1984 G 170/210/230 G 260/290 R370/390/420 M140/ 160/ M200/ 230 R 1990—>1992	PS150/ 160 G230/270 SP G MANAGER MAXTER MAGNUM KERAX MACK MIDLUM SISU PREMIUM	
54005	5000 815 714	Lock Washer ø56.5xø93x4.5	R370/390/420==>1989 R310/330/340/365 1984==> AE380/385TI/420TI500/520 R1990==>1992 R 1993==> G MANAGER 4x2 G MANAGER 6x2 & 6x4 AE MAGNUM 390/420 TI/430/470/560		
54666	---	Rep. Kit for Lock Washer Nut	PREMIUM TR 4X2 ==>1999 PREMIUM 6X2&6X2/4 ==>1999 PREMIUM PR 4X2 ==> 1999 MAGNUM E-TECH 400/440/480 PREMIUM(FAB22E/H/J/Q/R)2000==> PREMIUM(FAB22EE/HA/HB/JJ/QQ/RR		
53622	5010 224 222	Cap SW35/47	TR/ GR305 TR/ GR350 GB131/ HR15 GB/ TB191/ 231 GC191/ 231 GR191/ 231 GR/ TR280 R310 4X2 ->8/84 R360 4X2 PGC191/ 231 G260/ 290 C260/ 290 C210/ CLR220	G170 G210/ 230 R370 JSQ 1984 G320 R 1990—>1992 R 1993—> G220/270 BOM G MANAGER MAGNUM KERAX MIDLUM SISU PREMIUM	
54654	5010 457 148	Cap SW35/39.5	M/S 150/180/210/220/230TI/250 MIDLUM(FAB42B1/2-43C1/2-43T/V) MIDLUM EXPORT (FAB 43E1-43E2) MIDLUM 42B3/4-44T/V/C.-45D./E. MIDLUM 4X4 47XA/47XC PREMIUM(FAB22EE/HA/HB/JJ/QQ/RR MIDLUM(FAB 42US-44US-45US) MIDLUM DXI5/7-FAB-44.A/B/E/L/M		
54644	5001 821 839	Axle Bearing Bushing ø60xø65x70	AE380/385TI/420TI/500/520 R 1993---> G MANAGER 4X2 AE MAGNUM390/420TI/430/470/560		

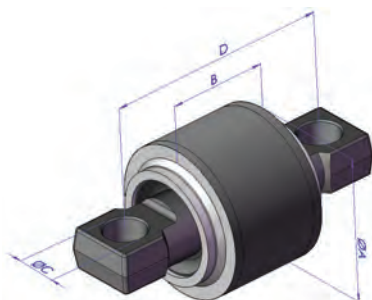

Auger Nr.	O.E.M. Nr.	A	B	C	D
51137	5001 842 823	ø85	54	ø19	130
51443	5001 836 091	ø75	48	ø19	130
52882	5000 802 123 - 5001 831 526	ø85	54	ø19	145
53712	5001 842 337	ø85	54	ø21	152
54572	5000 814 841	ø67	43	ø15	100
55119	7420 547 286	ø75	52	ø19	115
54583	5000 819 365 - 5010 104 465	ø75	48	ø17	122
54584	5000 823 228 S	ø75	48	ø16.5	122

Type-1

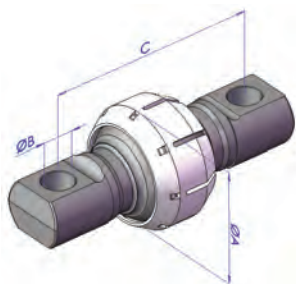

Type-2

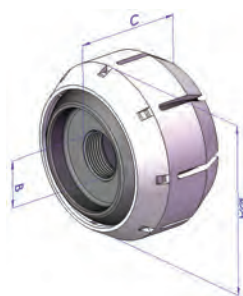

Type-3

















Auger Nr.	O.E.M. Nr.	A	B	C	Type
51142	0003 404 168	ø80	ø21	152	1
51448	7701 011 267	ø80	ø19	130	1
52034	5001 014 345	ø80	ø19	145	1
52036	0063 241 000	ø72	ø20	133	1
53713	5001 823 280	ø90	ø21	152	1
53741	0003 404 170	ø72	ø19	145	1
53201	5001 014 520	ø72	M20x1.5	46	2
52956	5001 832 613 - 4090 435 642	ø80	M30x2	169.5	3









Auger Nr.	OEM Nr.	Description	Model	Picture
51137	5001 842 823	Rep. Kit for Axle Rod ø85xø19/130	---	
51443	5001 836 091	Rep. Kit for Axle Rod ø75xø19/130	---	
52882	5000 802 123 5001 831 526	Rep. Kit for Axle Rod ø85xø19/145	GRH/TRH305 GRH/TRH350	
53712	5001 842 337	Rep. Kit for Axle Rod ø85xø21/152	KERAX ==> 1999 KERAX FAB 33A==>S 2000==>2002 KERAX (FAB 33AA.././SS) KERAX (FAB33A.././R) 2003==>	
54572	5000 814 841	Rep. Kit for Axle Rod ø67xø15/100	---	
54583	5000 819 365 5010 104 465	Rep. Kit for Axle Rod ø75xø17/122	---	















Auger Nr.	OEM Nr.	Description	Model	Picture
54584	5000 823 228 S	Rep. Kit for Axle Rod ø75xø16.5/122	M140/160/200/230 MIDLINER GRANDE-BRETAGNE M/S 150/180/210/220/230TI/250 MACK MS200/250/300 1990---> MACK CS200/250/300 1990--->	
55119	7420 547 286	Rep. Kit for Axle Rod ø75xø19/155	KERAX DXI 11 FAB-34.C/34.F PREMIUM DXI 7 -FAB-29.B/29.G PREMIUM -TR--FAB-24.F/25.C PREMIUM -PR--FAB-24.F/25.C	
53371	5010 294 576	Axle Rod Mounting ø90.5x73	MAXTER 6X4 8X4 KERAX ==> 1999 KERAX FAB 33A==>S 2000==>2002 KERAX (FAB 33AA.././SS)	
54350	5001 829 737	Axle Rod Mounting ø17/122xø72x67/116	AE380/385TI/420TI/500/520 R 1993---> AE MAGNUM390/420TI/430/470/560	
54351	5010 294 577	Axle Rod Mounting ø21/135xø90.5x70/170	MAXTER 6X4 8X4 KERAX==>1999 KERAX FAB 33A==>S 2000==>2002 KERAX (FAB 33AA.././SS)	
51142	0003 404 168	Rep. Kit for Axle Rod With Bolt ø80xø21/152	GBH260/280 6X6 GBH260/280 6X4 -->1980	















Auger Nr.	OEM Nr.	Description	Model	Picture
51143	5000 819 413	Rep. Kit for Axle Rod Without Bolt ø80	GRH235/HF26 GRH/TRH305 GRH/TRH350 GBH/TBH280 1981→ GBH260/280 6X6 GBH260/280 6X4 →1980 G260/290 C260/290 R360 6X4 → 10/1983 R310 6X4 JSQ 8/1984 R370 JSQ 1984 R370/390/420 →1989 R310/330/340/365 1984→ CBH/CLM280/340	
51448	7701 011 267	Rep. Kit for Axle Rod With Bolt ø80xø19/130	---	
52034	5001 014 345	Rep. Kit for Axle Rod With Bolt ø80xø19/145	GBH260/280 6X6 CBH/ CLM280/ 340 AE380/ 385TI/ 420TI/ 500/ 520 R 1990→1992 C230/ 280/ 300/ 340TI/ CCH300 CBH/CLM 320/385 R 1993→ G MANAGER 6X2 & 6X4 AE MAGNUM390/420TI/430/470/560 KERAX ==> 1999 MAGNUM E-TECH 400/440/480 KERAX FAB 33A==>S 2000==>2002	
53706	5001 014 424	Rep. Kit for Axle Rod Without Bolt ø80	GBH260/280 6X6 CBH/ CLM280/ 340 AE380/ 385TI/ 420TI/ 500/ 520 R 1990→1992 C230/ 280/ 300/ 340TI/ CCH300 CBH/CLM 320/385 R 1993→ G MANAGER 6X2 & 6X4 AE MAGNUM390/420TI/430/470/560 KERAX ==> 1999 MAGNUM E-TECH 400/440/480 KERAX FAB 33A==>S 2000==>2002	
52036	0063 241 000	Rep. Kit for Axle Rod With Bolt ø72xø20/133	C 38/38 T C 3064 C 3464 C 3864 R	
52510	5000 819 414	Rep. Kit for Axle Rod Without Bolt ø90	GBH260/280 6X6 GBH260/280 6X4 →1980	

Auger Nr.	OEM Nr.	Description	Model	Picture
52956	5001 832 613 4090 435 642	Rep. Kit for Axle Rod With Bolt M30x2/ø80x169.5	---	
53201	5001 014 520	Rep. Kit for Axle Rod M20x1.5/ø72x46	---	
53713	5001 823 280	Rep. Kit for Axle Rod With Bolt ø90xø21/152	MAXTER 6X4 8X4 G340TI 6X6 KERAX ==> 1999 KERAX FAB 33A==>S 2000==>2002 KERAX (FAB 33AA.././SS) KERAX (FAB33A.././R) 2003==>	
53714	5001 823 279	Rep. Kit for Axle Rod Without Bolt ø90	MAXTER 6X4 8X4 G340TI 6X6 KERAX ==> 1999 KERAX FAB 33A==>S 2000==>2002 KERAX (FAB 33AA.././SS) KERAX (FAB33A.././R) 2003==>	
53741	0003 404 170	Rep. Kit for Axle Rod With Bolt ø72xø19/145	GBH260/280 6X4 —>1980	
53742	5000 819 415	Rep. Kit for Axle Rod Without Bolt ø72	GBH260/280 6X4 —>1980	

Auger Nr.	OEM Nr.	Description	Model	Picture
15025	5010 094 838	Torque Rod L: 575	GRH235/ HF26 GRH/ TRH305 GRH/ TRH350 GBH/TBH280 1981 → GBH260/280 6X6 G260/ 290 C260/ 290 R360 6X4 → 10/1983 R310 6X4 JSQ 8/1984 R370 JSQ 1984 R370/390/420 → 1989 R310/330/340/365 1984 → CBH/ CLM280/ 340 AE380/385TI/420TI 500/ 520 R 1990 → 1992 C230/ 280/ 300/ 340TI/ CCH300 CBH/CLM 320/385 R 1993 → G MANAGER 6X2 & 6X4 MAGNUM KERAX	
	5010 064 641			
	5010 094 941			
	5000 750 976			52034 - ø80
	5001 850 530			
	0023 123 253			
	5000 783 574			52034 - ø80
15153	5010 094 839	Torque Rod L: 575	MAXTER 6X4 8X4 G340TI 6X6 KERAX ⇒ 1999 KERAX FAB 33A → S2000 → 2002 KERAX (FAB 33AA././SS) KERAX (FAB33A././R) 2003 ⇒	
				
				
				53713 - ø90
15154	5010 467 915	Torque Rod L: 575	KERAX FAB 33A → S2000 → 2002 KERAX (FAB 33AA././SS) KERAX (FAB33A././R) 2003 ⇒	
				
				
53712 - ø85	53712 - ø85			
15161	5010 268 035	Torque Rod L: 575	CBH/CLM 320/385	
				
52882 - ø85		52882 - ø85		

Auger Nr.	OEM Nr.	Description	Model	Picture
10387	5010 151 530 5010 207 728	Tie Rod L: 555	FR1	
10390	5000 998 430 5010 174 785	Tie Rod L: 1200	---	  10090 10090
10391	5010 308 082 5010 566 059	Tie Rod L: 1710	PREMIUM 400 PREMIUM 420	  10031 10031
10396	5010 145 080	Tie Rod Steering L: 1695	R 340 R 350	 10001 10001
10397	5000 145 581 5000 791 032 5010 308 215 5010 791 275	Tie Rod L: 1600	R 340 R 350	  10001 10001

Auger Nr.	OEM Nr.	Description	Model	Picture
10530	5010 239 386 5010 130 739	Tie Rod Steering L: 1018	R 1993 →	  10001  10001
10554	5010 566 063 5010 439 021	Tie Rod Steering L: 1750	Magnum	  10368  10368
10555	5000 613 837	Tie Rod Steering L: 1510	Midliner	  10003  10003
10556	5001 824 214 5010 059 544	Tie Rod Steering L: 845	CLM/CBH	  10001  10001
10557	5010 130 710	Tie Rod Steering L: 1030	R 1993 →	  10001  10001

Auger Nr.	OEM Nr.	Description	Model	Picture
10607	5010 488 052 5010 229 242	Tie Rod Steering L: 930	Maxter G 340	  10001  10001
10608	5430 122 944 5430 119 888	Tie Rod Steering L: 590	Maxter	  10001  10001
10609	5010 560 064	Tie Rod Steering L: 1650	Premium 420	  10368  10368
10610	5010 566 048	Tie Rod Steering L:	Mascot	  10656  10656
10611	5010 488 464	Tie Rod Steering L:	Mascot	  10656  10656

Auger Nr.	OEM Nr.	Description	Model	Picture
10612	5010 488 164	Tie Rod Steering L: 890	Midlum	
				 10616  10616
10613	5010 630 255	Tie Rod Steering L: 907	Midlum	
				 10007  10007
10626	5010 557 523 5010 383 203	Tie Rod Steering L: 745	Magnum	
				 10001  10001
10627	5001 868 374	Tie Rod Steering L: 655	Magnum	
				 10615  10615
10632	5001 868 366 5010 587 038	Tie Rod Steering L: 1680	Premium 440 DXI	
				 10368  10368

Auger Nr.	OEM Nr.	Description	Model	Picture
10633	5001 868 363 5010 600 822	Tie Rod Steering L: 1710	Premium 440 DXI	   10368 10368
10644	0005 003 046	Tie Rod Steering L: 775	---	   10003 10003
10373	5010 138 060 5010 130 453 0023 123 247 5000 748 784 5000 748 868 5000 874 577	Drag Link L: 1012	R 340 MAJOR R 340	   10001 10001
10374	5010 130 393	Drag Link L: 872	MIDLINER M 140 MIDLINER M 250 MIDLINER S 120 MIDLINER S 220	   10003 10003
10375	5000 786 902 5010 145 077 0023 123 224 0023 123 230 0023 123 241	Drag Link L: 1690	MIDLINER M 140 MIDLINER M 250 MIDLINER S 120 MIDLINER S 220	   10021 10021





Auger Nr.	OEM Nr.	Description	Model	Picture
10376	5010 239 340	Drag Link L: 1018	R340 MAJOR R 340	   10001 10001
10377	5000 745 719 5010 144 551 5010 144 556 5000 791 330	Drag Link L: 980	MANAGER G 200 MANAGER G 340 MAXTER G 230 MAXTER G 340	   10001 10001
10378	5000 725 267 5010 144 549 5010 144 552 5000 787 304 5000 787 305 5000 787 306	Drag Link L: 975	MANAGER G 200 MANAGER G 340 MAXTER G 230 MAXTER G 340	   10001 10001
10379	5010 037 602 5010 163 161 5010 037 603 5010 130 456	Drag Link L: 902	MIDLINER M 140 MIDLINER M 250 MIDLINER S 120 MIDLINER S 220	   10007 10007
10380	5010 060 764 5010 557 243	Drag Link L: 720	MAGNUM AE 420	   10001 10001

Auger Nr.	OEM Nr.	Description	Model	Picture
10381	5000 787 472 5010 130 483	Drag Link L: 825	C 260 C 340	  10001  10001 10001
10382	5000 761 670 5010 151 529 5010 207 725	Drag Link L: 1460	FR1	  10001  10001 10001
10383	5010 064 715 5010 130 382	Drag Link L: 830	CLM 385	  10001  10001 10001
10384	5000 541 230 5000 352 083 5000 352 082 5516 017 400 5516 017 831	Drag Link L: 873	MIDLINER S 170	  10003  10003 10003
10385	5000 785 429	Drag Link L: 895	GC 191/231 GR 191/231 GRH 235/ HF 26 PGC 191/231	  10001  10001 10001

Auger Nr.	OEM Nr.	Description	Model	Picture
10386	0023 123 262	Drag Link L: 490	GBH / TBH 280 GBH 260/280 GLM/TLM 280	 <p>10089 10089</p>
10388	5000 761 671 5010 151 528 5010 207 724	Drag Link L: 1475	FR1	 <p>10001 10001</p>
10389	5010 130 740 5010 239 387	Drag Link L: 1035	MAJOR R 340 MAJOR R 420 R R 340	 <p>10001 10001</p>
10392	5010 294 288	Drag Link L: 837	PREMIUM	 <p>10001 10001</p>
10393	5010 174 787 5000 932 435	Drag Link L: 987	---	 <p>10091 10091</p>







Auger Nr.	OEM Nr.	Description	Model	Picture
10394	5010 294 289	Drag Link L: 861	PREMIUM	  10001  10001
10395	5010 130 344	Drag Link L: 750	MAGNUM AE 385 MAGNUM AE 420	  10001  10001
10398	5010 294 287	Drag Link L: 810	PREMIUM	  10001  10001
10399	5010 130 451	Drag Link L: 1012	R 310	  10001  10001
10400	5010 206 705 5010 393 579	Drag Link L: 955	---	  10001  10001





Auger Nr.	OEM Nr.	Description	Model	Picture
10001	0003 406 254	Tie Rod End L: 125 M30x1,5 RHT	MAGNUM AE 385	
	0003 406 260		MAGNUM AE 420	
	0003 406 261		R 340	
	0003 406 251		R 350	
	0003 406 236		C 260	
	0003 401 169		C 340	
	5000 804 824		FR1	
	5000 819 349		PREMIUM	
	5000 288 360			
	7701 001 412			
	0003 401 167			
	5000 590 236			
10002	0003 401 170	Tie Rod End L: 125 M30x1,5 LHT	MAGNUM AE 385	
	5000 288 361		MAGNUM AE 420	
	5001 832 581		R 340	
	5000 288 378		R 350	
	0003 406 252		C 260	
			C 340	
	FR 1			
	PREMIUM			
10003	0003 406 212	Tie Rod End L: 115 M 30x1,5 RHT	MIDLINER M 140	
	0003 406 253		MIDLINER M 250	
	5000 242 159		MIDLINER S 120	
	5000 295 214		MIDLINER M 220	
	5000 812 483		MIDLINER S 170	
	5001 831 473			
	5001 850 549			
	7701 016 946			
	5001 832 582			
10004	0003 406 218	Tie Rod End L: 115 M 30x1,5 LHT	MIDLINER M 140	
	5000 295 215		MIDLINER M 250	
	5001 850 550		MIDLINER S 120	
	5001 834 533		MIDLINER S 220	
	5000 823 654		MIDLINER S 170	
	5000 820 879			
	5000 806 187			
	5000 588 470			
	5000 814 347			
	5000 295 336			
10007	5000 823 987	Tie Rod End L: 105 M28x1,5 RHT	MIDLINER	
	5000 559 335			
10008	5000 559 336	Tie Rod End L: 105 M 28x1,5 LHT	MIDLINER	
	5000 823 947			
	5000 823 997			



Auger Nr.	OEM Nr.	Description	Model	Picture
10021	0003 401 207	Tie Rod End	MANAGER	
	5001 832 580		MAXTER	
	5001 831 481	L: 125 M 38x1,5 RHT	MIDLINER	
10022	5001 832 579	Tie Rod End	MANAGER	
		L: 125 M 38x1,5 LHT	MAXTER MIDLINER	
10088	7700 658 834	Tie Rod End	---	
		L: 105 M 24x1,5 LHT		
10089	0023 123 262 P	Tie Rod End	GBH / TBH 280	
		L: 135	GBH 260/280	
		M 38x1,5 RHT	GLM/TLM 280	
10090	5010 174 785 P	Tie Rod End	PREMIUM	
		L: 125 M 30x1,5 RHT		
10091	5010 174 787 P	Tie Rod End	---	
		L: 125 M 30x1,5 RHT		

Auger Nr.	OEM Nr.	Description	Model	Picture
10614	5001 858 773 5001 858 774	Tie Rod End L: 125 M30x1,5 LHT	Kerax Master	
10615	5001 866 165	Tie Rod End L: 125 M30x1,5 RHT	Magnum	
10616	5001 859 985	Tie Rod End L: 125 M30x1,5 RHT	Midlum	
10617	5000 295 209 5000 824 448	Tie Rod End L:	Midlum	
10656	5001 860 769	Tie Rod End L:	MASCOTT	
10657	5000 288 362	Tie Rod End L:	MAJOR	

Auger Nr.	OEM Nr.	Description	Model	Picture
10661	5001 860 770	Tie Rod End L:	MASCOTT	
10662	5000 288 363	Tie Rod End L:	MAJOR	
10368	5001 858 763	Tie Rod End L: 146 M 30x1,5 RHT	PREMIUM MAGNUM MIDLUM SISU	
10531	5010 242 799	Ball Joint L: 68.5 M10x1.5 RHT	MAXTER G MANAGER PREMIUM MAGNUM KERAX MIDLUM MACK SISU	
10590	5010 133 895	Ball Joint L: 35 M6x1 LHT	AE380/ 385TI/ 420TI/ 500/ 520 G MANAGER G340TI TR 18T PREMIUM KERAX SISU	
10592	5010 245 591	Ball Joint L: 101 M10x1.5	PREMIUM KERAX MIDLUM	

Auger Nr.	OEM Nr.	Description	Model	Picture
10593	5010 239 842	Ball Joint L: 35 M6x1 RHT	AE380/385TI/420TI/500/520 G340TI TR 18T PREMIUM TR 4X2 =>1999 PREMIUM 6X2&6X2/4 =>1999 AE MAGNUM390/420TI/430/470 PREMIUM PR 4X2 => 1999 KERAX => 1999 KERAX FAB 33A=>S 2000=>2002	
10594	5010 211 555	Ball Joint L: 35 M6x1 LHT	AE380/385TI/420TI/500/520 M/S 150/180/210/220/230TI/250 R 1993-> G200/210/230TI G MANAGER 4X2 G340TI TR 18T PREMIUM KERAX MAGNUM MIDLUM	
10597	5010 144 543	Ball Joint L: 102 M14	PREMIUM MAGNUM MIDLUM KERAX	
10618	5010 245 365	Ball Joint L: 36	Premium ZF	
54377	0000 490 601	Dust Cover ø38xø152x51	GBH260/280 6X6 GBH260/280 6X4 ->1980	
54380	5010 152 854	Bushing ø30xø45.5x45	TR/GR350 GR/TR280 GRH/TRH305 GRH/TRH350 GBH/TBH280 1981-> GLC/GLR190y230 GLM/TLM280 GLR230 4X4 SINPAR 770KB6 SP	

Auger Nr.	OEM Nr.	Description	Model	Picture
53620	5010 094 716	Engine Mounting M20x2.5/97/70 Shore A	CBH/CLM280/340 AE380/385TI/420TI/500/520 CBH/CLM 320/385 AE MAGNUM390/420TI/430/470/560 MAGNUM E-TECH 400/440/480 SISU	
53693	5010 130 602	Engine Mounting M20x2.5/97/50 Shore A	AE380/385TI/420TI/500/520 AE MAGNUM390/420TI/430/470/560	
53623	5010 316 158	Engine Mounting 159x255x95	AE MAGNUM390/420TI/430/470/560 MAGNUM E-TECH 400/440/480 SISU	
54300	5010 460 240	Engine Mounting, Left 180x250x140	KERAX(FAB 33AA.././SS)	
54301	5010 460 241	Engine Mounting, Right 180x250x140	KERAX(FAB 33AA.././SS)	

Auger Nr.	OEM Nr.	Description	Model	Picture
53624	5010 316 680	Engine Mounting, Left 132x369x130	PREMIUM TR 4X2 2000 ==> PREMIUM(FAB22E/H/J/Q/R)2000==> PREMIUM TRACTEUR 4X2(FAB 22CC) PREMIUM(FAB22EE/HA/HB/JJ/QQ/RR) PREMIUM PR 4X2 (FAB 22AA/AB) PREMIUM 22C 071 ==> 1999	
53625	5010 316 681	Engine Mounting, Right 132x369x130	PREMIUM TR 4X2 2000 ==> PREMIUM(FAB22E/H/J/Q/R)2000==> PREMIUM TRACTEUR 4X2(FAB 22CC) PREMIUM(FAB22EE/HA/HB/JJ/QQ/RR) PREMIUM PR 4X2 (FAB 22AA/AB) PREMIUM 22C 071 ==> 1999	
53627	5010 460 352	Engine Mounting, Right 132x369x130	PREMIUM TR 4X2 2000 ==> PREMIUM(FAB22E/H/J/Q/R)2000==> PREMIUM PR 4X2 (FAB22A)2000==>	
53948	5010 460 351	Engine Mounting, Left 132x369x130	PREMIUM TR 4X2 2000 ==> PREMIUM(FAB22E/H/J/Q/R)2000==> PREMIUM PR 4X2 (FAB22A)2000==>	
54298	5010 460 353	Engine Mounting, Left 150x315x155	PREMIUM PR 4X2 ==> 1999 PREMIUM 260 SP PREMIUM PR 4X2 (FAB22A)2000==>	
54299	5010 460 354	Engine Mounting, Right 150x315x155	PREMIUM PR 4X2 ==> 1999 PREMIUM 260 SP PREMIUM PR 4X2 (FAB22A)2000==>	

Auger Nr.	OEM Nr.	Description	Model	Picture
54290	5010 316 591	Engine Mounting, Left ø20/160x106	PREMIUM TR 4X2 2000 ==> PREMIUM TRACTEUR 4X2(FAB 22CC) PREMIUM(FAB22EE/HA/HB/JJ/QQ/RR) PREMIUM PR 4X2 (FAB 22AA/AB) PREMIUM 22C 071 ==> 1999	
54291	5010 316 592	Engine Mounting, Right ø20/160x106	-PREMIUM TR 4X2 2000 ==> PREMIUM TRACTEUR 4X2(FAB 22CC) PREMIUM(FAB22EE/HA/HB/JJ/QQ/RR) PREMIUM PR 4X2 (FAB 22AA/AB) PREMIUM 22C 071 ==> 1999	
54292	5010 316 521	Engine Mounting, Left ø20/160x106	PREMIUM TR 4X2 ==>1999 PREMIUM 6X2&6X2/4 ==>1999 PREMIUM PR 4X2 ==> 1999 PREMIUM 260 SP PREMIUM TR 4X2 2000 ==> PREMIUM(FAB22E/H/J/Q/R)2000==> PREMIUM PR 4X2 (FAB22A)2000==> PREMIUM 22C 071 ==> 1999	
54293	5010 316 522	Engine Mounting, Right ø20/160x106	PREMIUM TR 4X2 ==>1999 PREMIUM 6X2&6X2/4 ==>1999 PREMIUM PR 4X2 ==> 1999 PREMIUM 260 SP PREMIUM TR 4X2 2000 ==> PREMIUM(FAB22E/H/J/Q/R)2000==> PREMIUM PR 4X2 (FAB22A)2000==> PREMIUM 22C 071 ==> 1999	
54294	5010 460 294	Engine Mounting, Left ø20/160x106	PREMIUM TR 4X2 2000 ==> PREMIUM(FAB22E/H/J/Q/R)2000==> PREMIUM TRACTEUR 4X2(FAB 22CC) PREMIUM(FAB22EE/HA/HB/JJ/QQ/RR) PREMIUM PR 4X2 (FAB 22AA/AB)	
54295	5010 460 295	Engine Mounting, Right ø20/160x116	PREMIUM TR 4X2 2000 ==> PREMIUM(FAB22E/H/J/Q/R)2000==> PREMIUM TRACTEUR 4X2(FAB 22CC) PREMIUM(FAB22EE/HA/HB/JJ/QQ/RR) PREMIUM PR 4X2 (FAB 22AA/AB)	

Auger Nr.	OEM Nr.	Description	Model	Picture
54296	5010 316 573	Engine Mounting, Left ø20/160x106	PREMIUM PR 4X2==> 1999 PREMIUM PR 4X2(FAB22A)2000==>	
54297	5010 316 574	Engine Mounting, Right ø20/160x106	PREMIUM PR 4X2==> 1999 PREMIUM PR 4X2(FAB22A)2000==>	
53703	5010 467 526	Engine Mounting M10/M12x46	MAXTER 6X4 8X4 G MANAGER 4X2 G MANAGER 6X2 & 6X4 G340TI 6X6 G340TI 4X4 MAXTER 4X2-4X4 KERAX ==> 1999 KERAX FAB 33A==>S 2000==>2002 KERAX (FAB33A/././R) 2003==> KERAX 33G ARMEE BANGLADESH KERAX 33K ARMEE BANGLADESH	
53626	5010 316 876	Engine Mounting M10/M12x46	MIDLINER GRANDE-BRETAGNE M/S 4X4 & INCENDIE M/S 150/180/210/220/230TI/250 S135/150 (MOT 040226) MS300 SUDAMERICA MIDLUM(FAB42B1/ 2- 43C1/ 2- 43T/ V) MIDLUM EXPORT (FAB 43E1-43E2) MACK MS200/250/300 1990--> MACK CS200/250/300 1990-->	
54653	5010 316 115	Engine Mounting M10/M12	PREMIUM PR 4X2 ==> 1999 PREMIUM(FAB22E/H/J/Q/R)2000==> PREMIUM PR 4X2 (FAB22A)2000==> PREMIUM(FAB22EE/HA/HB/JJ/QQ/RR PREMIUM PR 4X2 (FAB 22AA/AB)	
54289	5000 788 730	Engine Mounting ø19/ø35xø62/ø75x79.5	TR/GR305 GR/TR280 GRH/TRH305 R310 4X2-->8/84 GLC/GLR190/230 R310 6X4 JSQ 8/1984 GLR230 4X4 SINPAR R370/390/420->1989 R310/330/340/365 1984--> R 1990-->1992 R 1993-->	

Auger Nr.	OEM Nr.	Description	Model	Picture
53671	5000 748 630	Engine Mounting ø16x72	TR/GR305 GR/TR280 GRH/TRH305 R310 4X2 ->8/84 R310 6X4 JSQ 8/1984 R310/330/340/365 1984—> R 1990—>1992 R 1993—>	
54302	5000 750 515	Engine Mounting ø22.5xø75x90	GB131/ HR15 - GF151D 180/210 PJK/ P/JN/ PJP - JE13/ 15 M/S 150/180/210/220/ JN55/ 60/ 85 - JP11/ 13 230TI/250 JK55/ 60/ 65/ 75 PS150/160 JR/ JX19/ 21 - G170 G200/ 210/ 230TI S170 (FAB=SH) M210 4X4 J& S4X4-> 5/ 1991 MS300 SUDAMERICA S130/150TI (VF6JN) MIDLUM(FAB42B1 /2- S130/150TI/170 (VF6JP) 43C1 /2-43T/V) S110/ 130(VF6JK) MIDLUM EXPORT (FAB M140/ 160/ 200/ 230 43E1-43E2) MIDLINER GRANDE- MACK MS200/250/300 BRETAGNE 1990—> S140/ 160 MACK CS200/250/300 M/S 4X4 & INCENDIE 1990—> ME/ SE/ CE/ 160/	
54372	---	Engine Mounting ø16/ø32x58/70 ShA	---	
54375	0000 250 074	Engine Mounting ø30xø86x120	---	
54379	0945 331 007	Engine Mounting ø16/ø32x58/60 ShA	GB/TB191/231 770KB6 SP GC191/231 G320 GR191/231 G230/270 SP GRH235/HF26 G220/270 BOM TF231D G MANAGER 4X2 PGC191/231 G MANAGER 6X2 & GLC/GLR190/230 6X4 G260/290 PG230/280 GLR230 4X4 SIN- PAR G210/230	
53621	5010 130 072	Rubber Mounting for Engine Suspension ø28xø99x65	C230/ 280/ 300/ 340TI/ 43C1/ 2- 43T/ V) CCH300 MIDLUM EXPORT (FAB MAXTER 6X4 8X4 43E1-43E2) PS150/ 160 KERAX FAB 33A==>S G200/ 210/ 230TI 2000==>2002 G MANAGER 4X2 KERAX (FAB G MANAGER 6X2 & 6X4 33AA././SS) G340TI 6X6 KERAX (FAB33A//R) G340TI 4X4 2003==> MAXTER 4X2-4X4 MACK MS200/250/300 KERAX ==> 1999 1990—> PA200/ 210 MACK CS200/250/300 PG230/ 280 1990—> MIDLUM(FAB42B1/ 2-	

Auger Nr.	OEM Nr.	Description	Model	Picture
53655	5010 239 498	Rubber Mounting for Engine Suspension ø28xø106x64	AE380/ 385TI/ 420TI/ 500/ 520 G340TI TR 18T PREMIUM TR 4X2 ==>1999 PREMIUM 6X2&6X2/4 ==>1999 AE MAGNUM390/420TI/430/470/560 PREMIUM PR 4X2 ==> 1999 PREMIUM 260 SP	
53686	5000 704 265	Rubber Mounting for Engine Suspension ø27xø80x30	GBH/TBH280 1981 --> 470/560 GBH260/280 6X6 PREMIUM PR 4X2 ==> 1999 G260/ 290 - GLM/ TLM280 KERAX ==> 1999 CBH/ CLM280/ 340 PA200/210 PREMIUM 260 SP AE380/ 385TI/ 420TI/ 500/ 520 PG230/ 280 C230/ 280/ 300/ 340TI MIDLUM/ FAB42B1/ 2- 43C1/ CCH300 2- 43T/ V MAXTER 6X4 8X4 MIDLUM EXPORT (FAB 43E1- CBH/CLM 320/385 43E2) FS150/ 180 KERAX FAB 33A==>S G200/ 210/ 230TI 2000==>2002 G MANAGER 4X2 KERAX (FAB 33AA/././SS) G MANAGER 6X2 & 6X4 KERAX (FAB33A/./R) G340TI 6X6 2003==> G340TI 4X4 MACK MS200/250/300 1990-> G340TI TR 18T MACK CS200/250/300 1990-> PREMIUM TR 4X2 ==>1999 KERAX 33G ARMEE PREMIUM 6X2&6X2/4 BANGLADESH ==>1999 KERAX 33K ARMEE MAXTER 4X2-4X4 BANGLADESH AE MAGNUM390/420TI/430/	
54006	5000 704 264	Rubber Mounting for Engine Suspension ø27.5xø100x64	GBH/TBH280 1981 --> GBH260/280 6X6 G260/290 GLM/TLM280 CBH/CLM280/340 CBH/CLM 320/385 G MANAGER 4X2 G MANAGER 6X2 & 6X4	
54378	0000 482 344	Filter Hose ø100xø130x130	GBH260/280 6X4 -->1980	

Type-1

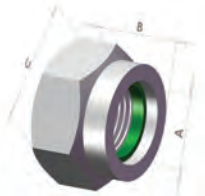





Type-2



Auger Nr.	O.E.M. Nr.	A	B	C	Type	Repair Kit
53299	5003 034 262	M20x2.5	20	SW 30	1	54667
54049	5003 034 252	M16x1.5	16	SW 24	1	53729-54668-54669
51677	5003 001 151	M16x2	130	SW 24	2	54008

Auger Nr.	OEM Nr.	Description	Model	Picture
53723	---	Rep. Kit for Engine Mounting ø28xø106x64	AE380/385TI/420TI/500/520 AE MAGNUM390/420TI/430/470/560	
53729	---	Rep. Kit for Engine Mounting ø28xø99x65	KERAX ==> 1999 KERAX FAB 33A==>S 2000==>2002 KERAX (FAB 33AA/././SS) KERAX (FAB33A/././R) 2003==>	
54008	---	Rep. Kit for Engine Mounting ø27.5xø100x64	GBH/TBH280 1981—> GBH260/280 6X6 GLM/ TLM280 CBH/ CLM280/ 340	
54667	5000 750 515 S	Rep. Kit for Engine Mounting ø22.5xø75x90	G170 - G200/210/230TI - GF151D J&S4X4->5/1991-JE13/15-JK55/60/65/75 JN55/60/85 - JP11/13- JR/JX19/21 - M/S 4X4 & INCENDIE - M140/160/200/230 M210 4X4-MACK CS200/250/300 1990-> MACK MS200/250/300 1990----> ME/SE/CE/160/180/210 MIDLINER GRANDE-BRETAGNE MIDLUM EXPORT (FAB 43E1-43E2) MS300 SUDAMERICA S130/150TI (VF6JN) - S170 (FAB-SH) S130/150TI/170 (VF6JP) - S140/160	
54668	---	Rep. Kit for Engine Mounting ø28xø99x65	C230/280/300/340TI/CCH300 G200/210/230TI MIDLUM(FAB42B1 /2-43C1/2-43TV) MIDLUM EXPORT (FAB 43E1-43E2) MACK MS200/250/300 1990—> MACK CS200/250/300 1990—>	
54669	---	Rep. Kit for Engine Mounting ø26xø106x64	PREMIUM TR 4X2 ==>1999 PREMIUM 6X2&6X2/4==>1999 PREMIUM PR 4X2 ==> 1999 PREMIUM 260 SP	







Auger Nr.	OEM Nr.	Description	Model	Picture
53678	5000 589 888	Propeller Shaft Bearing ø50	TR/GR305 GR191/231 GR/TR280 R310 4X2 ->8/84 G260/290 C260/290 G170 G210/230	
53694	5000 242 914	Propeller Shaft Bearing ø45	GB131/ HR15 G210/ 230 GB/ TB191/ 231 S130/150TI/170 GC191/ 231 (VF6JP) GR191/ 231 - GF151D M140/ 160/ 200/ 230 PJK/ PJV/ PJP C230/ 280/ 300/ 340TI/ PGC191/ 231 CCH300 GLC/ GLR190/ 230 ME/SE/CE/ JE13/ 15 160/180/210 C260/ 290 PS150/ 160 - S120/ 135 JP11/ 13 S135/150 JR/ JX19/ 21 (MOT040226) S170 (FAB=SH) MIDLUM C210/ CLR220 - G170	
54655	5000 819 188	Propeller Shaft Bearing ø55	R310 4X2 -->8/84 R310/330/340/365 1984-> - G320 AE380/385TI/420TI/500/520 R 1990--->1992 R 1993---> G MANAGER 4X2 G MANAGER 6X2 & 6X4 PREMIUM 6X2&6X2/4 ==>1999 AE MAGNUM390/420TI/430/470/560 PREMIUM(FAB22E/H/J/Q/R)2000==> PREMIUM(FAB22EE/HA/HB/JJ/QQ/RR) PREMIUM PR 4X2 (FAB 22AA/AB)	
54656	5000 816 925	Propeller Shaft Bearing ø55	G260/290 G220/270 BOM G200/210/230TI G MANAGER 4X2 PREMIUM 6X2&6X2/4 ==>1999 PREMIUM PR 4X2 ==> 1999 M210 4X4 MIDLUM(FAB42B1/2-43C1/2-43T/V) PREMIUM(FAB22E/H/J/Q/R)2000==> PREMIUM PR 4X2 (FAB22A)2000==> MIDLUM EXPORT (FAB 43E1-43E2)	
54657	5001 858 507	Propeller Shaft Bearing ø55	---	
54658	5000 820 884	Propeller Shaft Bearing ø50	G260/290 G220/270 BOM G200/210/230TI G MANAGER 4X2 PREMIUM PR 4X2 (FAB22A)2000==> MIDLUM EXPORT (FAB 43E1-43E2) MIDLUM 42B3/4-44T/V/C.-45D./E. PREMIUM(FAB22EE/HA/HB/JJ/QQ/RR) PREMIUM PR 4X2 (FAB 22AA/AB) MIDLUM(FAB 42US-44US-45US)	







Auger Nr.	OEM Nr.	Description	Model	Picture
55434	0003 397 101	Propeller Shaft Bearing ø60	TR/GR305 TR/GR350 R310 4X2 -->8/84 R360 4X2 GBH260/280 6X6 C260/290 GLM/TLM280 R370 JSQ 1984 CBH/CLM280/340 G320 R 1990---->1992 MAXTER 6X4 8X4 CBH/CLM 320/385 R 1993----> G MANAGER 4X2 G MANAGER 6X2 & 6X4 MAXTER 4X2-4X4	
55436	5000 560 295 5000 242 509	Propeller Shaft Bearing ø35	SG2 DEP 1979 B90 JE13/15 SG3 B70 S100 JN55/60/85 B80/110/120 JK55/60/65/75 S130/150TI (VF6JN) J35/48/55/60 SG4 S110/130 (VF6JK)	
55456	5000 821 936	Propeller Shaft Bearing ø45	130/150TI (VF6JN)	
55457	5000 819 211 5001 845 474 0003 997 101	Propeller Shaft Bearing ø60	AE380/385TI/420TI/500/520 R 1993----> PREMIUM 6X2&6X2/4 ==>1999 AE MAGNUM390/420TI/430/470/560 PREMIUM PR 4X2 ==> 1999 KERAX ==> 1999 MAGNUM E-TECH 400/440/480 PREMIUM(FAB22E/H/J/Q/R)2000==> KERAX FAB 33A==>S 2000==>2002 PREMIUM(FAB22EE/HA/HB/JJ/QQ/RR) PREMIUM PR 4X2 (FAB 22AA/AB) KERAX (FAB 33AA././SS) KERAX (FAB33A././R) 2003==> PREMIUM -PR--FAB-27RC/SC	

Auger Nr.	OEM Nr.	Description	Model	Picture	
54352	5000 750 738	Silent Block for Gearbox ø18xø56x70	KERAX PREMIUM MAGNUM G MANAGER MAXTER G260/290		
54353	5010 377 555	Silent Block for Gearbox ø18xø56x70	PG230/280 PREMIUM		
53969	0023 535 072	Gearbox Mounting M14/ø80x66	GR/TR280 GBH/TBH280 1981 → GBH260/280 6X6 GBH260/280 6X4 →1980 G260/290 GLM/TLM280 CBH/CLM280/340 CBH/CLM 320/385		
53715	---	Ball Joint Set M6x1	G340TI TR 18T PREMIUM TR 4X2 ==>1999 PREMIUM 6X2&6X2/4 ==>1999	 10594 10593	
53629	5010 570 047	Rubber Mounting for Radiator M10/ø39x28.5	GB/TB191/231 GC191/231 GR191/231 GRH235/HF26 SG2 DEP 1979 PGC191/231 GBH260/280 6X6 GBH260/280 6X4 770KB6 SP S100/110/130 (VF6JK) M140/160/200/230 S120/135/140/160 PS150/160	G230/270 SP G220/270 BOM G200/210/230TI G MANAGER G340TI 4X4 6X6 G340TI TR 18T MIDLUM MAXTER PA200/210 PG230/280 PREMIUM MAGNUM KERAX	
54376	5000 418 144	Rubber Mounting for Radiator ø20xø42x42	C260/290 C210/CLR220		

Auger Nr.	OEM Nr.	Description	Model	Picture
54968	5010 315 487	Silicon hose ø90x255	Premium Magnum	
54969	5010 315 483	Silicon hose ø90x255	Premium	
54970	5010 514 310	Silicon hose ø79x325	Premium Kerax	
55013	5010 211 836 5010 138 320 5010 095 482	Silicon hose ø76x100	G MANAGER R 1990--->1992 - R 1993---> AE MAGNUM390/420TI/430/470/560 AE380/385TI/420TI/500/520 B80/110/120 - CBH/CLM280/340 CBH/CLM320/385 - G200/210/230TI G230/270 - G340TI GBH/TBH280 1981-> - GBH260/280 GLM/TLM280 - GR/TR280 GRH/TRH305 - MAXTER 4X2-4X4 MAXTER 6X4 8X4 - R310 4X2-->8/84 R310 6X4 - R310/330/340/365 R370/390/420 - TR/GR305	
55014	5005 026 298	Silicon hose ø60x70	Premium Kerax	
55015	---	Silicon hose ø15x60	---	
55046	5010 514 309	Silicon hose ø80x280x210	Premium Kerax	

Auger Nr.	OEM Nr.	Description	Model	Picture
55047	5010 514 306	Silicon hose ø80x325x330	Premium Kerax	
53619	5000 750 630	Rubber Mounting for Exhaust M10/ø49x35.5	C260/290 C210/CLR220 C230/280/300/340TI/CCH300 PREMIUM	
54374	0000 689 778	Rubber Mounting for Exhaust ø15xø50x20	TR/GR305 TR/GR350 GR/TR280 GRH/TRH305 GRH/TRH350 R310 4X2->8/84 R360 4X2 GBH/TBH280 1981-> GBH260/280 6X6 G260/290 R360 6X4->10/1983 R310 6X4 JSQ 8/1984	
53133	5001 835 165	Rubber Bushing for Shock Absorber ø19xø50.5x26	AE380/ 385TI/ 420TI/ 500/ 520 G340TI TR 18T PREMIUM TR 4X2 =>1999 PREMIUM 6X2&6X2/4 =>1999 AE MAGNUM390/420TI/430/470/560 PREMIUM PR 4X2 => 1999 KERAX => 1999 PREMIUM 260 SP PG230/ 280 MAGNUM E-TECH 400/440/480 PREMIUM TR 4X2 2000 => PREMIUM(FAB22E/ H/ J/ Q/ R) 2000=> KERAX FAB 33A=>S 2000=>2002 PREMIUM 22C 071 => 1999	
52659	5010 353 702	Gas Spring 660 mm/350N	PREMIUM SISU KERAX	
54360	5010 227 221 5010 445 375	Gas Spring 405mm/150N	AE380/385TI/420TI/500/520 AE MAGNUM390/420TI/430/470/560 MAGNUM E-TECH 400/440/480 MAGNUM DX112 -VAR-120AV	

Auger Nr.	OEM Nr.	Description	Model	Picture
54361	5010 290 528 5010 445 244	Gas Spring 235mm/250N	PREMIUM TR 4X2 ==>1999 PREMIUM 6X2&6X2/4 ==>1999 PREMIUM PR 4X2 ==> 1999 KERAX ==> 1999 - SISU PREMIUM 22C 071 ==> 1999 PREMIUM TR 4X2 2000 ==> PREMIUM(FAB22EH/H/J/Q/R)2000==> PREMIUM PR 4X2 (FAB22A)2000==> KERAX FAB 33A==>S 2000==>2002 PREMIUM TRACTEUR 4X2(FAB 22CC) PREMIUM(FAB22EE/HA/HB/JJ/QQ/RR PREMIUM PR 4X2 (FAB 22AA/AB) KERAX (FAB 33AA/././SS) KERAX (FAB33A/./R) 2003==> PREMIUM DXI 11 -FAB-27JC/TC PREMIUM DXI 11 -FAB-27RC/SC	
54362	5010 353 703	Gas Spring 635mm/200N	PREMIUM TR 4X2==>1999 PREMIUM 6X2&6X2/4 ==>1999 PREMIUM PR 4X2==> 1999 KERAX==>1999 PREMIUM 260 SP PREMIUM TR 4X2 2000 ==> PREMIUM(FAB22E/H/J/Q/R)2000--> PREMIUM PR 4X2(FAB22A)2000==> KERAX FAB 33A==>S 2000==>2002	
54363	5010 225 922	Gas Spring 635mm/350N	PREMIUM TR 4X2 ==>1999 PREMIUM 6X2&6X2/4==>1999 PREMIUM PR 4X2 ==> 1999	
54364	5010 468 003	Gas Spring 615mm/230N	PREMIUM 260 SP PREMIUM TR 4X2 2000 ==> PREMIUM(FAB22E/H/J/Q/R)2000==> PREMIUM PR 4X2 (FAB22A)2000==> KERAX FAB 33A==>S 2000==>2002 PREMIUM TRACTEUR 4X2(FAB 22CC) PREMIUM(FAB22EE/HA/HB/JJ/QQ/RR PREMIUM PR 4X2 (FAB 22AA/AB) KERAX (FAB 33AA/././SS) KERAX (FAB33A/./R) 2003==> SISU	
54365	5010 578 586	Gas Spring 630mm/400N	PREMIUM DXI 11-FAB-27RC/SC PREMIUM DXI 11-FAB-27JC/TC	
54468	5010 093 384	Gas Spring 690mm/460N	R 1990---->1992 R 1993---->	

Auger Nr.	OEM Nr.	Description	Model	Picture
53611	5000 677 320	Ball Joint M16x2/ø44x60	BH/TBH280 1981—> - GBH260/280 6X6 G260/290 - C260/290 - GLM/TLM280 R370/390/420 —>1989 R310/330/340/365 1984—> CBH/CLM280/340 - G320 AE380/385TI/420TI/500/520 R 1990—>1992 C230/280/300/340TI/CCH300 MAXTER 6X4 8X4 - CBH/CLM 320/385 R 1993—> - G230/270 SP G220/270 BOM G MANAGER 4X2 G MANAGER 6X2 & 6X4 G340TI 6X6 - G340TI 4X4 G340TI TR 18T MAXTER 4X2-4X4 - PG230/280	
53612	5000 787 873	Ball Joint Bearing ø44x17	R310 4X2 ->8/84 - R360 4X2 GBH/TBH280 1981-> - GBH260/280 6X6 G260/290 - C260/290 R360 6X4 —> 10/1983 R310 6X4 JSQ 8/1984 - R 1990->1992 GLM/TLM280 - R370 JSQ 1984 R370/390/420 —>1989 R310/330/340/365 1984—> CBH/CLM280/340 - G320 AE380/385TI/420TI/500/520 C230/280/300/340TI/CCH300 MAXTER 6X4 8X4 - CBH/CLM 320/385 R 1993—> - G230/270 SP G220/270 BOM - G MANAGER 4X2 G MANAGER 6X2 & 6X4 G340TI 6X6 - G340TI 4X4 -G340TI TR 18T MAXTER 4X2-4X4 - PG230/280	
54358	0000 165 918	Return Spring ø20x145	TR/GR305 PGC191/231 TR/GR350 GBH260/280 6X6 GB/TB191/231 GBH260/280 6X4- GC191/231 >1980 GR191/231 GLC/GLR190/230 GRH235/HF26 R360 6X4- GR/TR280 >10/1983 GRH/TRH305 R310 6X4 JSQ GRH/TRH350 8/1984 TF231D GLM/TLM280 R310 4X2 —>8/84 GLR230 4X4 SIN- R360 4X2 PAR GBH/TBH280 770KB6 SP 1981—> G230/270 SP	
54651	5010 244 216	Return Spring ø21x155	R310 4X2 —>8/84 - R360 4X2 GBH/TBH280 1981—> GBH260/280 6X6 - G260/290 C260/290 - R360 6X4 —>10/1983 R310 6X4 JSQ 8/1984 GLM/TLM280 - R370 JSQ 1984 R370/390/420 —>1989 R310/330/340/365 1984—> CBH/CLM280/340 - G320 AE380/385TI/420TI/500/520 R 1990—>1992 - MAXTER 6X4 8X4 C230/280/300/340TI/CCH300 CBH/CLM 320/385 - R 1993—> G230/270 SP - G220/270 BOM G MANAGER 4X2 - G340TI 6X6 G MANAGER 6X2 & 6X4 G340TI 4X4 - G340TI TR 18T MAXTER 4X2-4X4 AE MAGNUM390/420TI/430/470/560	
53610	0000 149 310	Filler Cap ø37xø54.5x31	TR/ GR305/ 350 C210/ CLR220 GB131/HR15 G170/ 210/ 230/ 260/ GB/ TB191/ 231 290/ 320 GC191/ 231 R370 JSQ 1984 GR191/ 231 770KB6 SP GRH235/ HF26 R370/390/420 —>1989 GR/ TR280 R310/330/340/365 GRH/ TRH305/ 350 1984—> TF231D CBH/ CLM280/ 340 GF151D M140/ 160/ 200/ 230 R310 4X2 ->8/84 AE380/ 385TI/ 420TI/ R360 4X2 500/ 520 PGC191/ 231 R 1990—>1992 GLC/ GLR190/ 230 PREMIUM JE13/ 15 MAGNUM C260/ 290 MIDLUM R360 6X4 —> 10/1983 KERAX R310 6X4 JSQ 8/1984 MAXTER GLR230 4X4 SINPAR	
53616	5516 031 803	Filler Cap M73x4/48	GB131/HR15 R370/390/420 —>1989 GB/TB191/231 R310/330/340/365 1984-> GC191/231 - GR191/231 S100/110/130 (VF6JK) GRH235/HF26 - TF231D CBH/CLM280/340 GF151D - PJK/PJNPJP M140/160/200/230 PGC191/231 - JE13/15 ME/SE/CE/ 160/180/210 G260/290 - C260/290 MAXTER 6X4 8X4 JN55/60/85 - JP11/13 CBH/CLM 320/385 JK55/60/65/75 M/S 150/180/210/220/ S170 (FAB=SH) 230TI/250 C210/CLR220 R 1993—> - S120/135 G170/210/230/320 G220/270 BOM S130/150TI (VF6JN) G200/210/230TI S130/150TI/170 (VF6JP) G MANAGER 4X2	

Auger Nr.	OEM Nr.	Description	Model	Picture
54649	5010 269 022	Return Spring ø21.5x79.5	AE380/385TI/420TI/500/520 R 1990--->1992 C230/280/300/340TI/CCH300 MAXTER 6X4 8X4-CBH/CLM 320/385 R 1993---> - G220/270 BOM G MANAGER 4X2 G MANAGER 6X2 & 6X4 G340TI 4X4 - G340TI TR 18T MAXTER 4X2-4X4 AE MAGNUM390/420TI/430/470/560 PREMIUM	
54650	5010 230 676	Return Spring ø16.5x55	PREMIUM MIDLUM SISU KERAX	
53705	0000 270 526	Return Spring ø14.7x76.5	GB/TB191/231 - GC191/231 R 1990-->1992 GR191/231 - GRH235/HF26 C230/280/300/340TI/CCH300 TF231D - R310 4X2 ->864 CBH/CLM 320/385 GBH/TBH280 1981--> MS 150/180/210/220/230TI/250 PGC191/231 - GBH260/280 6X6 PS150/ 160 - R 1993--> GLC/ GLR190/230 - G260/290 G230/270 SP - G220/270 BOM R310 6X4 JSQ 8/1984 G200/210/230TI GLM/ TLM280 G MANAGER 4X2 G170/ 210/ 230/ 320 G MANAGER 6X2 & 6X4 R370 JSQ 1984 - 770KB6 SP MAXTER R370/390/420 -->1989 MAGNUM R310/330/340/365 1984--> KERAX CBH/ CLM280/340 MIDLUM AE380/385TI/ 420TI/ 500/ 520 PREMIUM	
54381	7700 693 776	Idle Speed Adjustment ø12x59	GBH/TBH280 1981-> R 1990-->1992 GBH260/280 6X6 MAXTER 6X4 8X4 JE13/15 - C260/290 CBH/CLM 320/385 GLM/TLM280 R 1993-> - G230/270 SP C210/CLR220 G220/270 BOM S130/150TI (VF6JN) G200/210/230TI S130/150TI/170 (VF6JP) G MANAGER 4X2 & 6X2 R370/390/420->1989 G340TI 4X4 & 6X6 R310/330/340/365 1984-> PREMIUM - MAXTER CBH/CLM280/340 KERAX - MIDLUM - SISU	
20014	5010 294 307 CS 4911 N P01 S 4911 N P03 S	Piston for Air Bellow ø228x210	PREMIUM MAGNUM KERAX	
53628	5010 377 224	Rubber Mounting for Air Suspension M12/ø39x28	AE380/ 385TI/ 420TI/ 500/ 520 AE MAGNUM390/420TI/430/470/560 MAGNUM E-TECH 400/440/480	
53702	5000 739 051	Rubber Mounting for Air Suspension M16/ø100x73	GLC/GLR190/230 JE13/15 C260/290 GLR230 4X4 SINPAR C210/CLR220 CBH/CLM280/340 C230/280/300/340TI/CCH300 ME/SE/CE/ 160/180/210 CBH/CLM 320/385 MACK CS200/250/300 1990-->	